



Background suppression sensor

ML100-8-H-100-5986



- Diffuse mode sensor with multiple light spots
- Specially designed for detecting critical objects such as PCBs
- Miniature design
- Detects objects in front of a close background through precise background suppression
- Can be adapted to the application in question thanks to the adjustable detection range
- Precision object detection, almost irrespective of the color
- Not sensitive to ambient light, even with switched energy saving lamps

Diffuse mode sensor with special light spots for detecting PCBs, background suppression, miniature design, 100 mm detection range, red light, light on, PNP output, fixed cable with M8 plug



Function

The optical sensors of this series are suitable for both standard and demanding applications. The series features a miniature housing design, two M3 metal-threaded mounting holes and a highly visible LED status indicator. Each device is equipped with a sensitivity adjuster and a light-on/dark-on changeover switch for increased flexibility. A wide variety of versions are available in both infrared light and red light with PowerBeam for easy alignment. Special versions with BlueBeam are suitable for challenging applications like those in the solar and battery industries.

Application

File not found

Dimensions

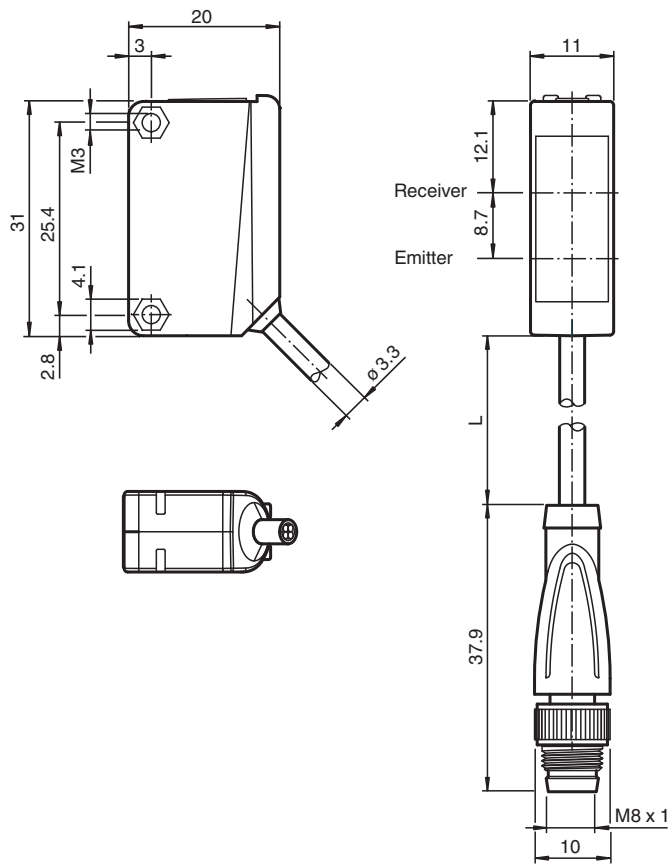

Technical Data

General specifications	
Detection range	20 ... 100 mm
Detection range min.	10 ... 25 mm
Detection range max.	25 ... 100 mm
Adjustment range	25 ... 100 mm
Reference target	standard white, 100 mm x 100 mm
Light source	LED
Light type	modulated visible red light
Polarization filter	no
Black-white difference (6 %/90 %)	< 20 %
Diameter of the light spot	3 light spots, spotsize 4 mm at a distance of 50 mm, spots are 8 mm apart; spotsize 2.5 mm at a distance of 80 mm, spots are 12 mm apart; spotsize 4 mm at a distance of 100 mm, spots are 15 mm apart
Optical face	frontal
Ambient light limit	EN 60947-5-2:2007+A1:2012
Functional safety related parameters	
MTTF _d	1100 a
Mission Time (T _M)	20 a
Diagnostic Coverage (DC)	0 %
Indicators/operating means	
Operation indicator	LED green: power on
Function indicator	LED yellow: lights when object is detected , flashes when in adjustment mode
Control elements	Sensing range adjuster

Release date: 2023-04-04 Date of issue: 2023-04-04 Filename: 258449_eng.pdf

Technical Data

Control elements	Light-on/dark-on changeover switch	
Electrical specifications		
Operating voltage	U_B	10 ... 30 V DC
Ripple		max. 10 %
No-load supply current	I_0	< 15 mA
Output		
Switching type	The switching type of the sensor is adjustable. The default setting is: light-on	
Signal output		1 PNP output, short-circuit protected, reverse polarity protected, open collector
Switching voltage	max. 30 V DC	
Switching current	max. 100 mA , resistive load	
Voltage drop	U_d	≤ 1.5 V DC
Switching frequency	f	500 Hz
Response time	1 ms	
Conformity		
Product standard	EN 60947-5-2	
Approvals and certificates		
UL approval	cULus Listed, Class 2 Power Source or listed Power Supply with a limited voltage output with (maybe integrated) fuse (max. 3.3 A according UL248), Type 1 enclosure	
CCC approval	CCC approval / marking not required for products rated ≤ 36 V	
Ambient conditions		
Ambient temperature	-30 ... 60 °C (-22 ... 140 °F)	
Storage temperature	-40 ... 70 °C (-40 ... 158 °F)	
Mechanical specifications		
Housing width	11 mm	
Housing height	31 mm	
Housing depth	20 mm	
Degree of protection	IP67	
Connection	400 mm fixed cable with plug with M8 connector, 3-pin	
Material		
Housing	PC (Polycarbonate)	
Optical face	PMMA	
Mass	approx. 50 g	
Tightening torque, fastening screws	0.6 Nm	
Cable length	0.4 m	

Connection

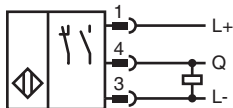

Connection Assignment

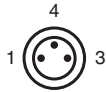

Wire colors in accordance with EN 60947-5-2

1	BN	(brown)
3	BU	(blue)
4	BK	(black)

Assembly

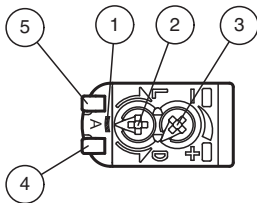

1	Alignment Mode	
2	Light-Dark-switching	
3	Sensitivity adjuster	
4	Signal display	yellow
5	Operating display	green

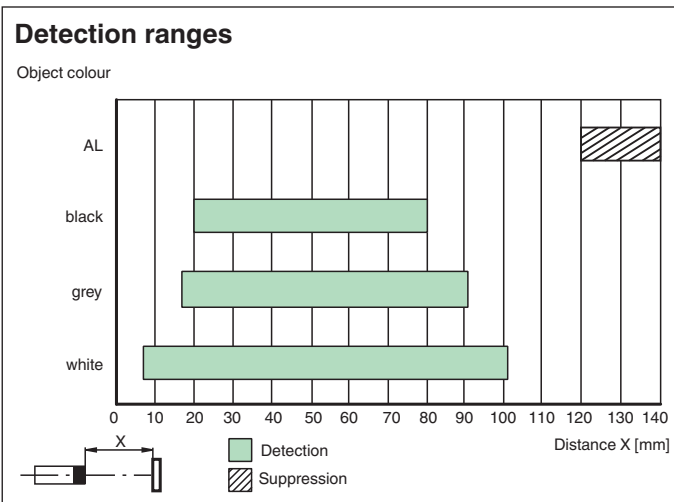



Accessories

	OMH-ML100-09	Mounting aid for round steel \varnothing 12 mm or sheet 1.5 mm ... 3 mm
	OMH-ML100-01	Mounting aid for ML100 series, mounting bracket
	OMH-ML100-02	Mounting aid for ML100 series, mounting bracket
	OMH-ML100-03	Mounting aid for round steel \varnothing 12 mm or sheet 1.5 mm ... 3 mm

Release date: 2023-04-04 Date of issue: 2023-04-04 Filename: 258449_eng.pdf

Refer to "General Notes Relating to Pepperl+Fuchs Product Information".

Accessories

	OMH-ML100-04	Mounting aid for ML100 series, mounting bracket
	OMH-ML100-05	Mounting aid for ML100 series, mounting bracket
	OMH-ML100-S2	Mounting aid for ML100 series, mounting bracket

Configuration Information

Setting mode (A-Mode):

A-Mode is an additional switch position that is integrated into the light ON/dark ON switch. A-Mode is located between position L and position D. A-Mode is a help mode which enables you to detect whether all three light spots are directed onto the object.

If A-Mode is selected, the yellow signal indicator LED flashes; the number of times that the LED flashes equates to the number of detected light spots.

The following scenarios exist:

- No flashing/LED off: No light spots detected
- Fast flashing (8 Hz): One light spot detected
- Slow flashing (4 Hz): Two light spots detected
- Static illumination/LED on: Three light spots detected

As soon as you exit A-Mode, the yellow LEDs light up in the standard manner again.