



Optical reading head PGV100R-F200-R4-1,5M

- Mechanically rugged: no wearing parts, long operating life, maintenance-free
- Serial interface RS 485, addressable
- Non-contact positioning on Data Matrix code tape
- Noncontact positioning with Data Matrix TAGs
- Reading of Data Matrix control codes
- Visible red light
- Fixed cable
- Terminating resistor, switchable

Read head for incident light positioning system



Dimensions

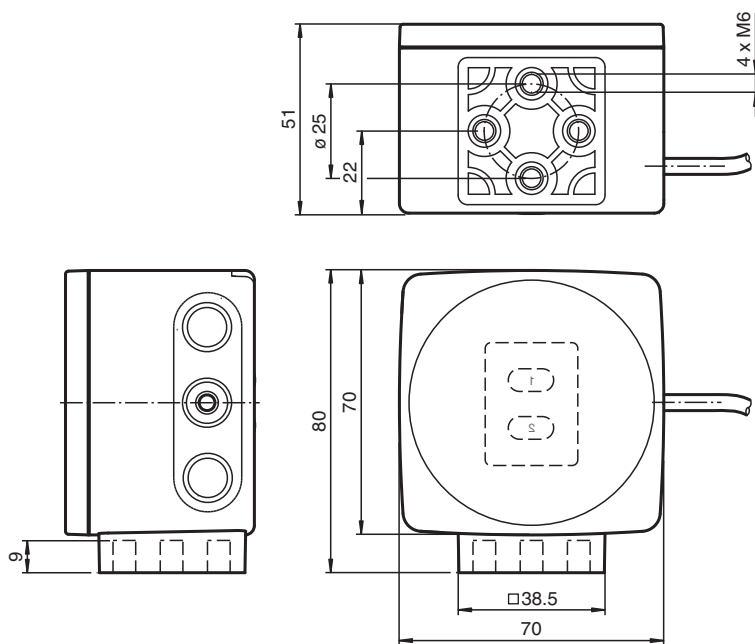

Technical Data

General specifications

Passage speed	v	≤ 8 m/s
Measuring range		max. 10000 m
Light type		Integrated LED lightning (red)
Scan rate		40 s ⁻¹
Latency		50 ms
Read distance		100 mm
Depth of focus		± 30 mm
Reading field		120 mm x 80 mm
Resolution		0.1 mm

Release date: 2023-02-24 Date of issue: 2023-02-24 Filename: 70103701_eng.pdf

Refer to "General Notes Relating to Pepperl+Fuchs Product Information".

Pepperl+Fuchs Group
www.pepperl-fuchs.com

USA: +1 330 486 0001
fa-info@us.pepperl-fuchs.com

Germany: +49 621 776 1111
fa-info@de.pepperl-fuchs.com

Singapore: +65 6779 9091
fa-info@sg.pepperl-fuchs.com

PF PEPPERL+FUCHS

Technical Data

Ambient light limit		100000 Lux
Accuracy		± 0.2 mm
Nominal ratings		
Camera		
Type		CMOS , Global shutter
Processor		
Clock pulse frequency		600 MHz
Speed of computation		4800 MIPS
Functional safety related parameters		
MTTF		68 a
MTTF _d		136 a
MTBF		68 a
Mission Time (T _M)		20 a
Diagnostic Coverage (DC)		0 %
Indicators/operating means		
LED indication		2 LEDs
Electrical specifications		
Operating voltage	U _B	15 ... 30 V DC , PELV
No-load supply current	I ₀	max. 200 mA
Power consumption	P ₀	3 W
Interface		
Interface type		RS 485 interface
Data output code		binary code
Transfer rate		115200 Bit/s
Termination		Switchable terminal resistor
Query cycle time		≥ 10 ms
Standard conformity		
Emitted interference		EN 61000-6-4:2007+A1:2011
Noise immunity		EN 61000-6-2:2005+AC:2005
Shock resistance		EN 60068-2-27:2009
Vibration resistance		EN 60068-2-6:2008
Approvals and certificates		
CCC approval		CCC approval / marking not required for products rated ≤36 V
Ambient conditions		
Operating temperature		0 ... 60 °C (32 ... 140 °F) , -20 ... 60 °C (-4 ... 140 °F) (noncondensing; prevent icing on the lens!)
Storage temperature		-40 ... 85 °C (-40 ... 185 °F)
Relative humidity		90 % , noncondensing
Mechanical specifications		
Connection type		Open cable end
Housing width		70 mm
Housing height		70 mm
Housing depth		50 mm
Degree of protection		IP40
Material		
Housing		PC/ABS
Cable		PVC
Cable		
Sheath diameter		5.8 mm
Strain relief		60 N
Length	L	1.5 m
Mass		approx. 200 g
Factory settings		

Release date: 2023-02-24 Date of issue: 2023-02-24 Filename: 70103701_eng.pdf

Refer to "General Notes Relating to Pepperl+Fuchs Product Information".

Pepperl+Fuchs Group
www.pepperl-fuchs.comUSA: +1 330 486 0001
fa-info@us.pepperl-fuchs.comGermany: +49 621 776 1111
fa-info@de.pepperl-fuchs.comSingapore: +65 6779 9091
fa-info@sg.pepperl-fuchs.com

PEPPERL+FUCHS

Technical Data

X resolution (protocol)	0.1 mm
Y resolution (protocol)	0.1 mm
Angle resolution	0.1 °
Baud rate	115200 Bit/s
Terminating resistor	On
Read head address	0

Connection

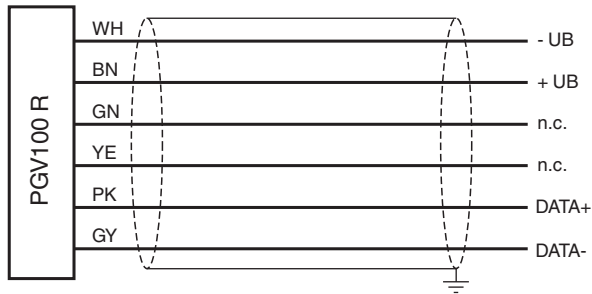

Function Principle

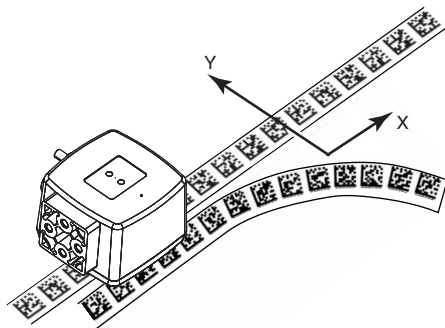

Release date: 2023-02-24 Date of issue: 2023-02-24 Filename: 70103701_eng.pdf

Refer to "General Notes Relating to Pepperl+Fuchs Product Information".

Pepperl+Fuchs Group
www.pepperl-fuchs.com

USA: +1 330 486 0001
fa-info@us.pepperl-fuchs.com



Germany: +49 621 776 1111
fa-info@de.pepperl-fuchs.com

Singapore: +65 6779 9091
fa-info@sg.pepperl-fuchs.com

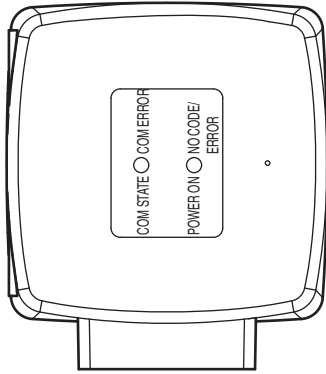

Function Principle



Matching System Components

	PGV*-CA25-*	Data Matrix code tape
	PGV85-CT4	Data Matrix tag for PGV system
	PGV*-CC25-*	Control code tape für PGV System

Accessories

	PCV-MB1	Mounting bracket for PCV* read head
	PCV-AG100	Alignment guide for PCV100-* read head