



Fiber optic sensor MLV41-LL-RT/95/136



- Robust fiber optic sensor for reliable operation under all conditions
- Adjustable continuous sensitivity
- Easy fiber optic installation with quick-action clamping lock
- Aluminum housing with high-quality Delta Seal coating

Robust fiber optic sensor for glass fiber optics, red light, push-pull output, M8 plug



Function

The unique and extremely popular design of the MLV41 series enables it to be mounted correctly in confined areas and offers all the functions that are normally only found on larger phototelectronic sensors. The MLV41 series comes with a range of functions. For example, highly visible status LEDs on the front and back, resistance to ambient light, crosstalk protection and universally applicable output stages that permit every possible switching logic and polarity to be realized. The enhanced resistance to ambient light ensures reliable operation even where modern energy-saving lamps with electronic ballasts are in use. The same applies where multiple devices are present, i.e. the use of a number of sensors in the same vicinity causes no problems.

Dimensions

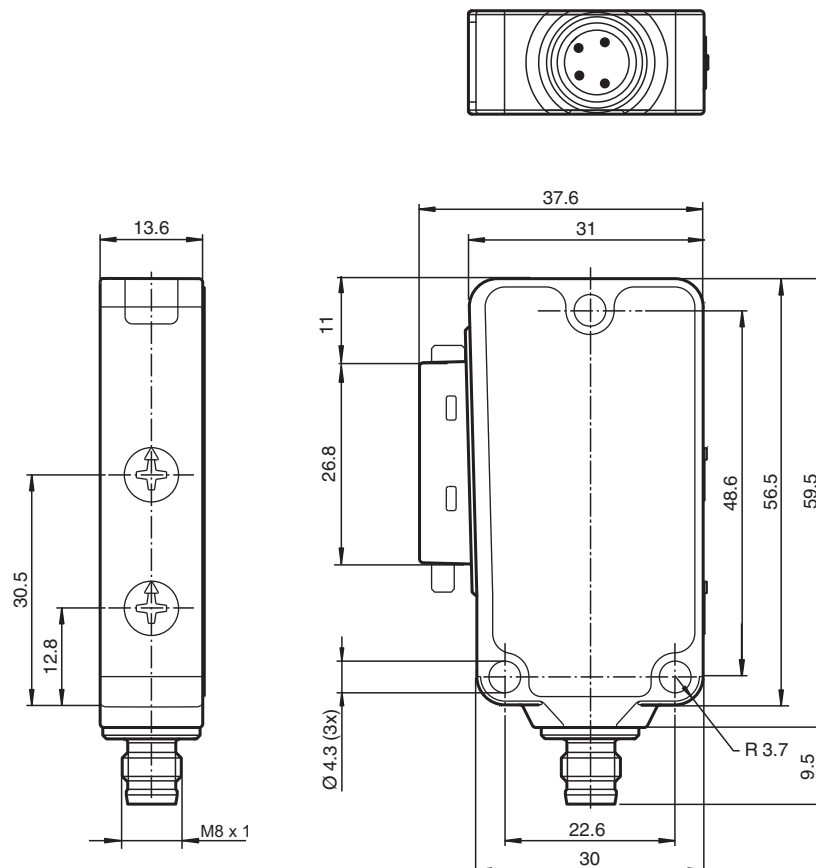

Release date: 2023-04-04 Date of issue: 2023-04-04 Filename: 249783_eng.pdf

Refer to "General Notes Relating to Pepperl+Fuchs Product Information".

Pepperl+Fuchs Group
www.pepperl-fuchs.com

USA: +1 330 486 0001
fa-info@us.pepperl-fuchs.com

Germany: +49 621 776 1111
fa-info@de.pepperl-fuchs.com

Singapore: +65 6779 9091
fa-info@sg.pepperl-fuchs.com

 PEPPERL+FUCHS

Technical Data

General specifications	
Sensor range	on black (6 %): up to 36 mm on Kodak white, reflection factor 90% up to 120 mm with LLR 04-1.6-0.5-WC3 fiberoptic cable
Adjustment range	0 ... 120 mm on Kodak white, reflection factor 90%
Reference target	100 mm x 100 mm on Kodak white, reflection factor 90%
Light source	LED
Light type	modulated visible red light , 660 nm
Functional safety related parameters	
MTTF _d	770 a
Mission Time (T _M)	20 a
Diagnostic Coverage (DC)	0 %
Indicators/operating means	
Operation indicator	LED green, statically lit Power on , Undervoltage indicator: Green LED, pulsing (approx. 0.8 Hz) , short-circuit : LED green flashing (approx. 4 Hz)
Function indicator	LED yellow, lights up with receiver lit ; flashes when falling short of the operating reserve
Control elements	Sensitivity adjuster, light/dark switch
Electrical specifications	
Operating voltage	U _B 10 ... 30 V DC
Ripple	max. 10 %
No-load supply current	I ₀ max. 40 mA
Output	
Switching type	light/dark on switchable The switching modes specified in the "Electrical Connection" section apply to L/D switches in the "D" position (dark switch)
Signal output	2 push-pull (4 in 1) outputs, complementary, short-circuit proof, reverse polarity protected
Switching voltage	max. 30 V DC
Switching current	max. 100 mA
Voltage drop	U _d ≤ 2.5 V DC
Switching frequency	f 1000 Hz
Response time	0.5 ms
Conformity	
Product standard	EN 60947-5-2
Approvals and certificates	
UL approval	cULus Listed 57M3 (Only in association with UL Class 2 power supply; Type 1 enclosure)
CCC approval	CCC approval / marking not required for products rated ≤36 V
Ambient conditions	
Ambient temperature	-20 ... 60 °C (-4 ... 140 °F)
Storage temperature	-40 ... 75 °C (-40 ... 167 °F)
Mechanical specifications	
Housing width	31 mm
Housing height	56.5 mm
Housing depth	13.6 mm
Fiber optic adapter	04
Degree of protection	IP67
Connection	M8 x 1 connector, 4-pin
Material	
Housing	Aluminum , Delta-Seal coated
Optical face	Fiber optic connection
Connector	metal
Mass	50 g

Release date: 2023-04-04 Date of issue: 2023-04-04 Filename: 249783_eng.pdf

Refer to "General Notes Relating to Pepperl+Fuchs Product Information".

Pepperl+Fuchs Group
www.pepperl-fuchs.comUSA: +1 330 486 0001
fa-info@us.pepperl-fuchs.comGermany: +49 621 776 1111
fa-info@de.pepperl-fuchs.comSingapore: +65 6779 9091
fa-info@sg.pepperl-fuchs.com

PEPPERL+FUCHS

Connection

Option:

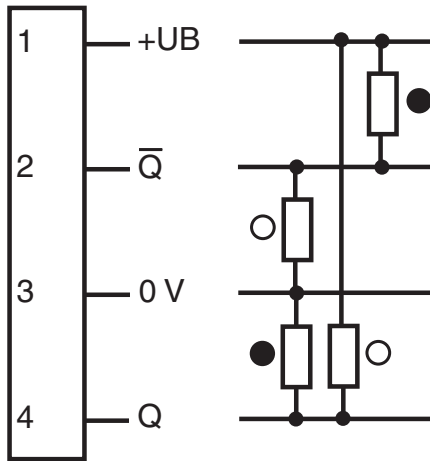

- = Light on
- = Dark on

Connection Assignment



Wire colors in accordance with EN 60947-5-2

1	BN	(brown)
2	WH	(white)
3	BU	(blue)
4	BK	(black)

Assembly

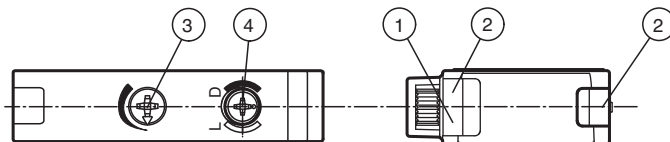

1	Operating display green	3	Sensing range adjuster
2	Function display yellow	4	Bright/dark switch

Accessories

	V31-WM-2M-PUR	Female cordset single-ended M8 angled A-coded, 4-pin, PUR cable grey
	V31-GM-2M-PUR	Female cordset single-ended M8 straight A-coded, 4-pin, PUR cable grey

Release date: 2023-04-04 Date of issue: 2023-04-04 Filename: 249783_eng.pdf

Refer to "General Notes Relating to Pepperl+Fuchs Product Information".

Pepperl+Fuchs Group
www.pepperl-fuchs.com









USA: +1 330 486 0001
fa-info@us.pepperl-fuchs.com

Germany: +49 621 776 1111
fa-info@de.pepperl-fuchs.com

Singapore: +65 6779 9091
fa-info@sg.pepperl-fuchs.com

PEPPERL+FUCHS

Accessories

	LCR 04-1,6-0,5-Z1	Glass fiber optic - diffuse with PVC covering
	LLR 04-1,6-0,5-G(M6x30)	Glass fiber optic - diffuse with metal silicone covering
	LCR 04-1,6-0,5-WC 3	Glass fiber optic - diffuse with PVC covering
	LLR 04-1,6-0,5-W C3	Glass fiber optic - diffuse with metal silicone covering
	LCE 04-1,6-1,0-Z1	Glass fiber optic - thru-beam with PVC covering
	LCE 04-1,6-1,0 G	Glass fiber optic - thru-beam with PVC covering
	LLE 04-1,6-1,0-G	Glass fiber optic - thru-beam with metal silicone covering
	LCE 04-1,6-1,0-W C3	Glass fiber optic - thru-beam with PVC covering
	LLE 04-1,6-1,0-W C3	Glass fiber optic - thru-beam with metal silicone covering