

Fieldbus module ICE1-16DI-G60L-V1D

- Multiprotocol-compatible
- M12 power connector
- Sturdy metallic housing
- Web-based configuration

Ethernet IO module with 16 digital inputs



Function

The ICE1-16DI-G60L-V1D is a multiprotocol fieldbus module with 16 digital inputs. The G60L design in fully cast metal housing is resistant to mechanical damage and environmental influences. The G60L has protection class IP65/IP67. The fieldbus module serves as an interface between the controller of a fieldbus system and the field level. Thanks to its multiprotocol capability, the fieldbus module supports the Ethernet communication protocols PROFINET, EtherNet/IP, and EtherCAT. An L-coded M12 connector plug used for supplying power enables a current rating of up to 2 x 16 A. The inputs are equipped with A-coded M12 connector plugs. Connection to the fieldbus is achieved using a D-coded M12 connector plug. The communication protocols are configured either manually via a rotary switch or automatically. The diagnostics display status information for each channel via LEDs. An integrated web server enables access to the fieldbus module. Information regarding the status of the module is also displayed and network parameters such as the IP address and subnet mask can be configured.

Dimensions

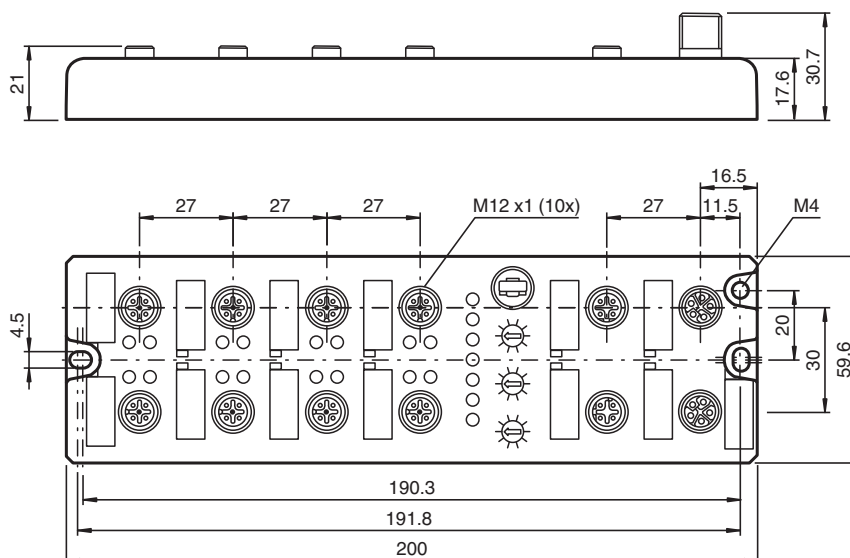

Release date: 2023-02-22 Date of issue: 2023-02-22 Filename: 295311_eng.pdf

Refer to "General Notes Relating to Pepperl+Fuchs Product Information".

Pepperl+Fuchs Group
www.pepperl-fuchs.com

USA: +1 330 486 0001
fa-info@us.pepperl-fuchs.com

Germany: +49 621 776 1111
fa-info@de.pepperl-fuchs.com

Singapore: +65 6779 9091
fa-info@sg.pepperl-fuchs.com

PF PEPPERL+FUCHS

Technical Data

| | | |
|-----------------------------------|----------------|---|
| General specifications | | |
| UL File Number | | E223772 |
| Indicators/operating means | | |
| LED indication | | see manual |
| Rotary switch | | Setting the fieldbus protocol |
| Electrical specifications | | |
| Rated operating voltage | U _e | 18 ... 30 V |
| Nominal voltage | | 24 V DC |
| Current consumption | | 120 mA |
| Current loading capacity | | Max. 2 x 16 A per module (Loop-through current via L-coded power supply) Total current: max. 9 A per module |
| Interface 1 | | |
| Interface type | | Industrial Ethernet |
| Physical | | M12, D-coded |
| Protocol | | PROFINET IO with media redundancy protocol (MRP) EtherNet/IP with Device Level Ring (DLR) EtherCAT |
| Transfer rate | | 10/100 Mbps |
| Input | | |
| Input type | | 2-, 3-, 4-wire PNP, DC |
| Number/Type | | 16 Digital inputs (X1 – X8) short-circuit protected |
| Supply | | 24 V DC from U _S |
| Input current | | 5 mA (limited internally) |
| Sensor supply | | max. 200 mA Per port (X1 - X8) |
| Switching point | | |
| 0 (unattenuated) | | > -3 VDC ... 5 VDC |
| 1 (attenuated) | | > 11 VDC 30 VDC |
| Fusing | | Electronic overload and short-circuit protection |
| Input filter | | 3 ms |
| Directive conformity | | |
| Electromagnetic compatibility | | |
| Directive 2014/30/EU | | EN 61000-6-2:2005, EN 61000-6-4:2007+A1:2011 |
| Standard conformity | | |
| Degree of protection | | EN 60529:2000 |
| Emitted interference | | EN 61000-6-4:2007+A1:2011 |
| Noise immunity | | EN 61000-6-2:2005 |
| Shock resistance | | EN 61131-2:2004 |
| Ambient conditions | | |
| Ambient temperature | | -20 ... 70 °C (-4 ... 158 °F) |
| Storage temperature | | -40 ... 70 °C (-40 ... 158 °F) |
| Cold start temperature | | -40 °C (-40 °F) |
| Relative humidity | | max. 95 % |
| Altitude | | 0 ... 2000 m |
| Shock and impact resistance | | 50 g, 11 ms, all axes |
| Vibration resistance | | 15 g at 5 - 500 Hz |
| Pollution degree | | 3 |
| Mechanical specifications | | |
| Contact elements | | PA |
| Degree of protection | | IP65/IP67/IP69K |
| Connection | | Power Supply M12, L-coded Fieldbus M12, D-coded Inputs M12, A-coded |
| Material | | |

Release date: 2023-02-22 Date of issue: 2023-02-22 Filename: 295311_eng.pdf

Refer to "General Notes Relating to Pepperl+Fuchs Product Information".

Pepperl+Fuchs Group
www.pepperl-fuchs.comUSA: +1 330 486 0001
fa-info@us.pepperl-fuchs.comGermany: +49 621 776 1111
fa-info@de.pepperl-fuchs.comSingapore: +65 6779 9091
fa-info@sg.pepperl-fuchs.com

PEPPERL+FUCHS

Technical Data

| | |
|--------------------------------------|--|
| Contacts | CuSn, gold-plated CuNi, gold-plated |
| Housing | Diecast zinc |
| Seal | FKM |
| Mass | 500 g |
| Tightening torque, fastening screws | 1 Nm |
| Tightening torque, cable gland | 0.6 Nm |
| Construction type | Field housing |
| Tightening torque of clamping screws | 0.5 Nm |

Connection

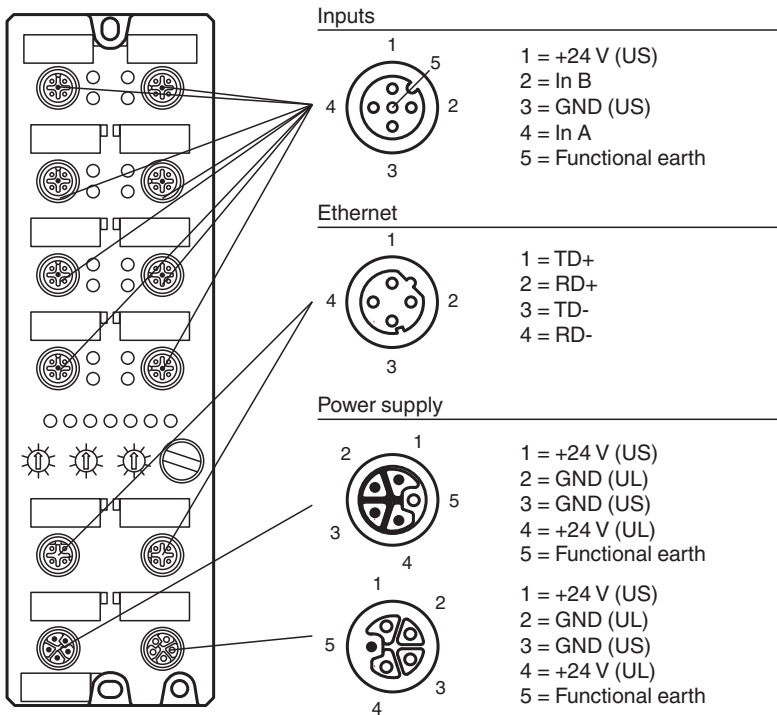



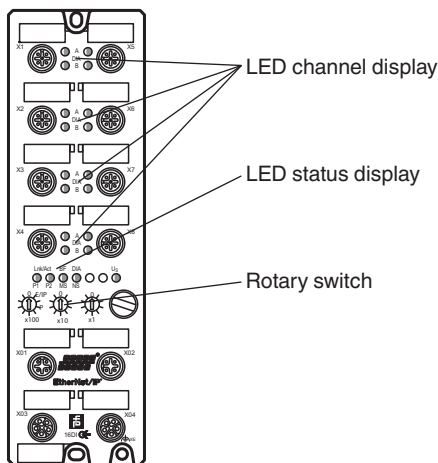









Assembly



Release date: 2023-02-22 Date of issue: 2023-02-22 Filename: 295311_eng.pdf

Refer to "General Notes Relating to Pepperl+Fuchs Product Information".

Accessories

| | | |
|---|----------------------------------|--|
|  | V15L-G-2M-PUR-U-V15L-G | Cordset M12 socket straight to M12 plug straight L-coded, 5-pin, PUR cable grey, UL approved |
|  | V15L-G-5M-PUR-U | Female cordset single-ended M12 straight L-coded, 5-pin, PUR cable grey, UL approved |
|  | V15L-G-BK | Female connector M12 straight L-coded 5-pin, for cable diameter 8 - 13 mm, field-attachable |
|  | V1SD-G-GN2M-PUR-E1S-V45-G | Ethernet bus cable M12 plug straight D-coded to RJ45 Ethernet-coded, 4-pin, PUR cable green, Cat5e, shielded, drag chain suitable |
|  | V1SD-G-GN2M-PUR-E1S-V1D-G | Ethernet bus cable M12 plug straight to M12 plug straight D-coded, 4-pin, PUR cable green, Cat5e, shielded, UL approved, drag chain suitable |
|  | V1SD-G-ABG-PG9 | Male connector M12 straight D-coded 4-pin, for cable diameter 5 - 8 mm, shielded, field-attachable |
|  | V1S-T-V1 | Y-Splitter M12 plug 5-pin to 2x M12 socket 4-pin A-coded |
|  | V1-G-BK1M-PUR-A-T-V1-G | Y connection cable M12 plug straight A-coded 4-pin to 2x M12 socket straight A-coded 4-pin, 2x PUR cable weld spatter resistant black, UL approved, drag chain suitable, torsion resistant |
|  | V1S-G-PG9 | Male connector M12 straight A-coded 4-pin, for cable diameter 6 - 8 mm, field-attachable |
|  | VAZ-V1-B3L | Blind plug for M12 sockets |
|  | MH V1-SCREWDRIVER | Torque screwdriver (0.6 Nm) |
|  | MH V1-BIT M12 | plug-in cap M12 |

Release date: 2023-02-22 Date of issue: 2023-02-22 Filename: 295311_eng.pdf

Refer to "General Notes Relating to Pepperl+Fuchs Product Information".

Pepperl+Fuchs Group
www.pepperl-fuchs.com

USA: +1 330 486 0001
fa-info@us.pepperl-fuchs.com

Germany: +49 621 776 1111
fa-info@de.pepperl-fuchs.com

Singapore: +65 6779 9091
fa-info@sg.pepperl-fuchs.com