



## Triangulation sensor (BGS) OBT300-R201-EP-IO-0,3M-V3



- Medium design with versatile mounting options
- Best background suppressor in its class
- Precision object detection, almost irrespective of the color
- Extended temperature range  
-40 °C ... 60 °C
- High degree of protection IP69K
- IO-Link interface for service and process data

Triangulation sensor with background suppression



**IO-Link**

### Function

The optical sensors in the series are the first devices to offer an end-to-end solution in a medium-sized standard design – from the thru-beam sensor through to the measuring distance sensor. As a result of this design, the sensors are able to perform practically all standard automation tasks.

The entire series enables sensors to communicate via IO-Link.

The DuraBeam laser sensors are durable and can be used in the same way as a standard sensor.

Multi Pixel Technology (MPT) ensures that the standard sensors are flexible and can be adapted to the application environment.

**Dimensions**

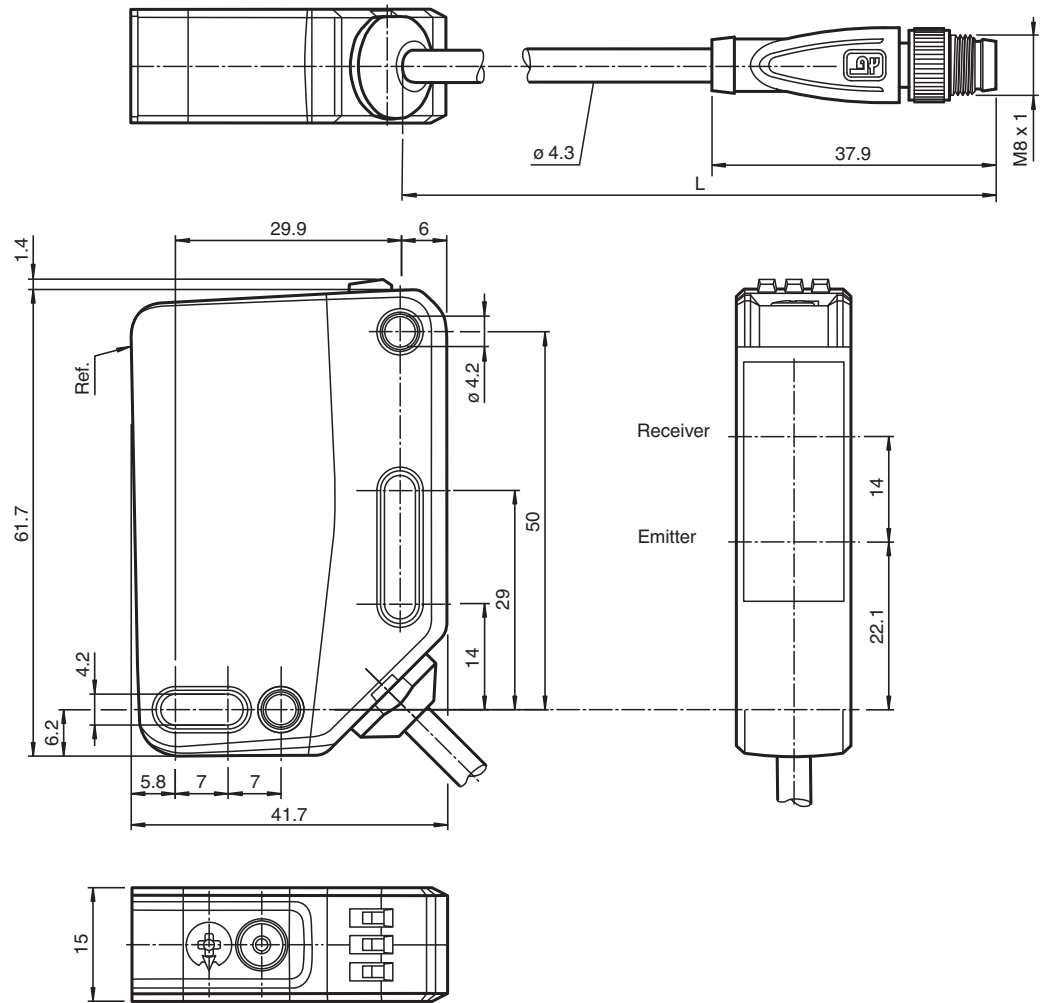

**Technical Data**

General specifications	
Detection range	30 ... 300 mm
Detection range min.	30 ... 80 mm
Detection range max.	30 ... 300 mm
Adjustment range	80 ... 300 mm
Reference target	standard white, 100 mm x 100 mm
Light source	LED
Light type	modulated visible red light
LED risk group labelling	exempt group
Black-white difference (6%/90%)	< 5 % at 300 mm
Diameter of the light spot	approx. 8 mm x 8 mm at a distance of 300 mm
Opening angle	approx. 1.5 °
Ambient light limit	EN 60947-5-2 : 70000 Lux
Functional safety related parameters	
MTTF <sub>d</sub>	600 a
Mission Time (T <sub>M</sub> )	20 a
Diagnostic Coverage (DC)	0 %
Indicators/operating means	
Operation indicator	LED green: constantly on - power on flashing (4Hz) - short circuit flashing with short break (1 Hz) - IO-Link mode

Release date: 2023-01-16 Date of issue: 2023-01-16 Filename: 295670-100210\_eng.pdf

## Technical Data

Function indicator		LED yellow: constantly on - object detected constantly off - object not detected
Control elements		Light-on/dark-on changeover switch
Control elements		Sensing range adjuster
<b>Electrical specifications</b>		
Operating voltage	$U_B$	10 ... 30 V DC
Ripple		max. 10 %
No-load supply current	$I_0$	< 26 mA at 24 V supply voltage
Protection class		III
<b>Interface</b>		
Interface type		IO-Link ( via C/Q = pin 4 )
IO-Link revision		1.1
Device profile		Identification and diagnosis Smart Sensor type 2.4
Device ID		0x111612 (1119762)
Transfer rate		COM2 (38.4 kBit/s)
Min. cycle time		2.3 ms
Process data width		Process data input 1 Bit Process data output 2 Bit
SIO mode support		yes
Compatible master port type		A
<b>Output</b>		
Switching type		The switching type of the sensor is adjustable. The default setting is: C/Q - Pin4: NPN normally open / light-on, PNP normally closed / dark-on, IO-Link
Signal output		1 push-pull (4 in 1) output, short-circuit protected, reverse polarity protected, overvoltage protected
Switching voltage		max. 30 V DC
Switching current		max. 100 mA , resistive load
Usage category		DC-12 and DC-13
Voltage drop	$U_d$	$\leq 1.5$ V DC
Switching frequency	f	500 Hz
Response time		1 ms
<b>Conformity</b>		
Communication interface		IEC 61131-9
Product standard		EN 60947-5-2
<b>Approvals and certificates</b>		
UL approval		E87056 , cULus Listed , class 2 power supply , type rating 1
CCC approval		CCC approval / marking not required for products rated $\leq 36$ V
<b>Ambient conditions</b>		
Ambient temperature		-40 ... 60 °C (-40 ... 140 °F) , fixed cable -20 ... 60 °C (-4 ... 140 °F) , movable cable not appropriate for conveyor chains
Storage temperature		-40 ... 70 °C (-40 ... 158 °F)
<b>Mechanical specifications</b>		
Housing width		15 mm
Housing height		61.7 mm
Housing depth		41.7 mm
Degree of protection		IP67 / IP69 / IP69K
Connection		300 mm fixed cable with M8 x 1, 3-pin connector
Material		
Housing		PC (Polycarbonate)
Optical face		PMMA
Mass		approx. 52 g
Cable length		0.3 m

Release date: 2023-01-16 Date of issue: 2023-01-16 Filename: 295670-100210\_eng.pdf

Refer to "General Notes Relating to Pepperl+Fuchs Product Information".

Pepperl+Fuchs Group  
www.pepperl-fuchs.comUSA: +1 330 486 0001  
fa-info@us.pepperl-fuchs.comGermany: +49 621 776 1111  
fa-info@de.pepperl-fuchs.comSingapore: +65 6779 9091  
fa-info@sg.pepperl-fuchs.com

**PEPPERL+FUCHS**

**Connection**



**Connection Assignment**



Wire colors in accordance with EN 60947-5-2

- 1 | BN (brown)
- 3 | BU (blue)
- 4 | BK (black)

**Assembly**

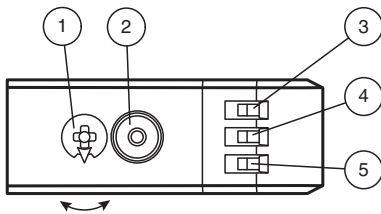

1	Sensitivity adjustment	
2	Light-on / dark-on changeover switch	
3	Operating indicator / dark on	GN
4	Signal indicator	YE
5	Operating indicator / light on	GN

**Characteristic Curve**

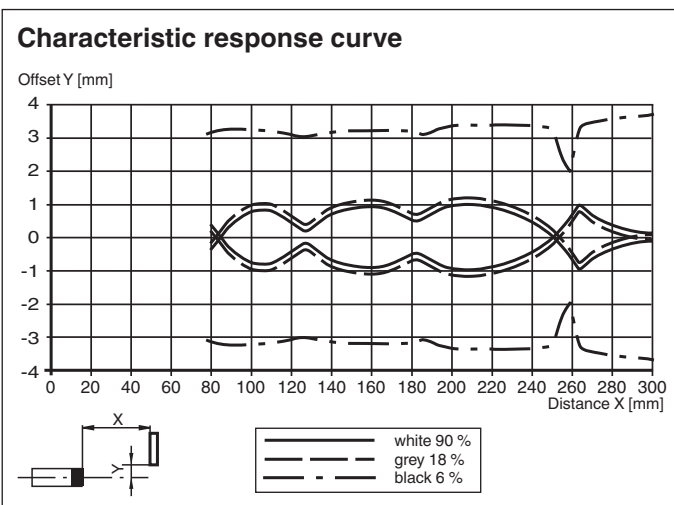

Release date: 2023-01-16 Date of issue: 2023-01-16 Filename: 295670-100210\_eng.pdf

Refer to "General Notes Relating to Pepperl+Fuchs Product Information".

## Characteristic Curve

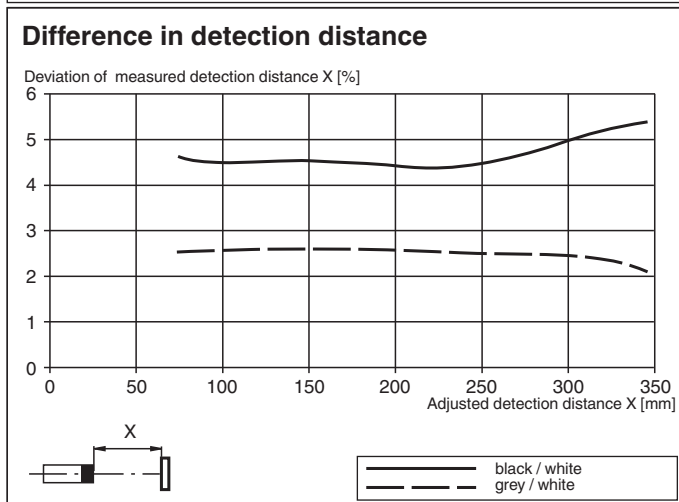
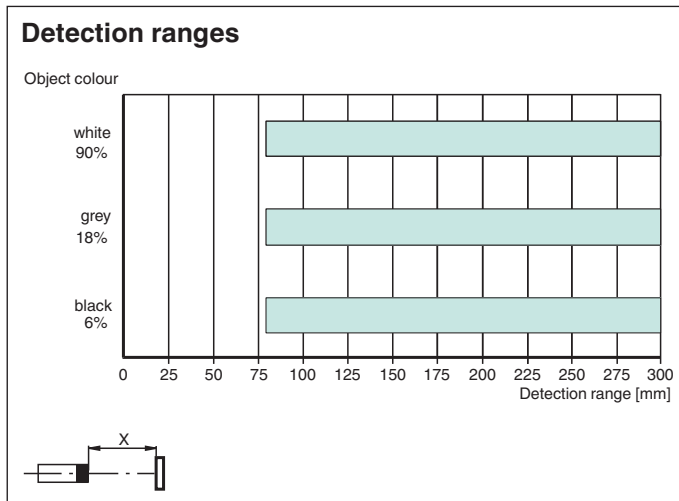









## Accessories

	<b>OMH-RL31-02</b>	Mounting bracket narrow
	<b>OMH-RL31-03</b>	Mounting bracket narrow
	<b>OMH-RL31-04</b>	Mounting aid for round steel $\varnothing$ 12 mm or sheet 1.5 mm ... 3 mm
	<b>OMH-RL31-07</b>	Mounting bracket including adjustment
	<b>OMH-RL31-08</b>	Mounting aid for round steel $\varnothing$ 12 mm or sheet 1.5 mm ... 3 mm
	<b>OMH-R20x-Quick-Mount</b>	Quick mounting accessory
	<b>ICE2-8IOL-G65L-V1D</b>	EtherNet/IP IO-Link master with 8 inputs/outputs
	<b>ICE3-8IOL-G65L-V1D</b>	PROFINET IO IO-Link master with 8 inputs/outputs

Release date: 2023-01-16 Date of issue: 2023-01-16 Filename: 295670-100210\_eng.pdf

**Accessories**

	<b>ICE2-8IOL-K45S-RJ45</b>	EtherNet/IP IO-Link master with 8 inputs/outputs, DIN rail, screw terminal
	<b>ICE3-8IOL-K45P-RJ45</b>	PROFINET IO IO-Link master with 8 inputs/outputs, DIN rail, push-in terminals
	<b>ICE3-8IOL-K45S-RJ45</b>	PROFINET IO IO-Link master with 8 inputs/outputs, DIN rail, screw terminal
	<b>IO-Link-Master02-USB</b>	IO-Link master, supply via USB port or separate power supply, LED indicators, M12 plug for sensor connection
	<b>ICE1-8IOL-G30L-V1D</b>	Ethernet IO-Link module with 8 inputs/outputs
	<b>ICE1-8IOL-G60L-V1D</b>	Ethernet IO-Link module with 8 inputs/outputs
	<b>ICE2-8IOL-K45P-RJ45</b>	EtherNet/IP IO-Link master with 8 inputs/outputs, DIN rail, push-in connectors
	<b>V3-GM-2M-PUR</b>	Female cordset single-ended M8 straight A-coded, 3-pin, PUR cable grey
	<b>V3-WM-2M-PUR</b>	Female cordset single-ended M8 angled A-coded, 3-pin, PUR cable grey

Release date: 2023-01-16 Date of issue: 2023-01-16 Filename: 295670-100210\_eng.pdf

Refer to "General Notes Relating to Pepperl+Fuchs Product Information".

Pepperl+Fuchs Group  
www.pepperl-fuchs.com

USA: +1 330 486 0001  
fa-info@us.pepperl-fuchs.com

Germany: +49 621 776 1111  
fa-info@de.pepperl-fuchs.com

Singapore: +65 6779 9091  
fa-info@sg.pepperl-fuchs.com

## Configuration

To unlock the adjustment functions, rotate the sensing range/sensitivity adjuster by more than 180°.

### **Sensing Range/Sensitivity**

To increase the sensing range/sensitivity, rotate the sensing range/sensitivity adjuster clockwise.

To reduce the sensing range/sensitivity, rotate the sensing range/sensitivity adjuster counter-clockwise.

As soon as the end of the adjustment range is reached, the signal indicator flashes at 8 Hz.

### **Configuring Light On/Dark On**

Press the light-on/dark-on changeover switch for more than 1 second (but less than 4 seconds). "Light on/dark on" mode changes and the relevant operating indicator lights up.

If you press the light-on/dark-on changeover switch for longer than 4 seconds, the "light on/dark on" mode will switch back to the original setting. The current status is activated when the light-on/dark-on changeover switch is released.

### **Restoring Factory Settings**

Press the light-on/dark-on changeover switch for more than 10 seconds (but less than 30 seconds) until all LEDs go out. When the light-on/dark-on changeover switch is released, the signal indicator lights up. After 5 seconds, the sensor resumes operation with the factory settings.

The adjustment functions are locked after 5 minutes of inactivity. To unlock the adjustment functions, rotate the sensing range/sensitivity adjuster again by more than 180°.