



# Optical reading head PGV100I-F200-B16-V15

- Mechanically rugged: no wearing parts, long operating life, maintenance-free
- CANopen interface
- Non-contact positioning on Data Matrix code tape
- Noncontact positioning with Data Matrix TAGs
- Reading of Data Matrix control codes
- Infrared light

Read head for incident light positioning system



## Dimensions

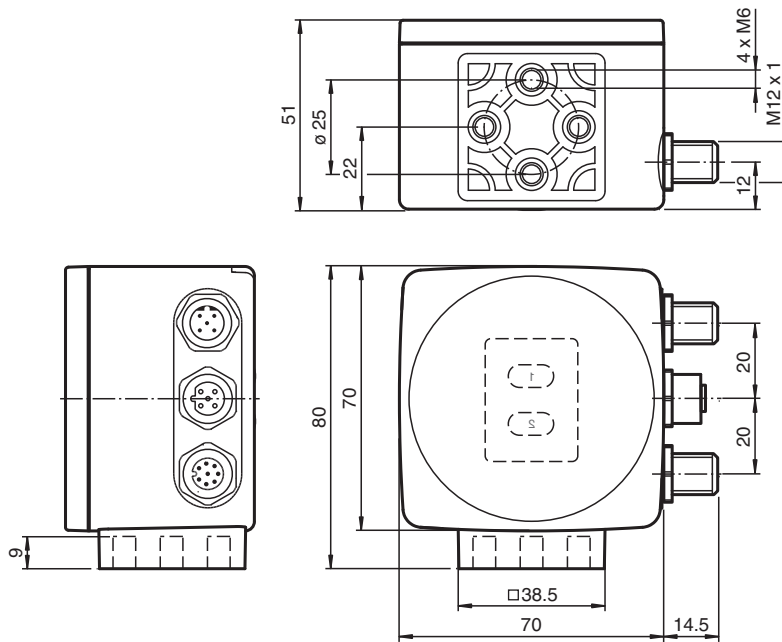

## Technical Data

### General specifications

Passage speed	v	≤ 8 m/s
Measuring range		max. 10000 m
Light type		Integrated LED lightning , infrared
Scan rate		40 s <sup>-1</sup>
Latency		50 ms
Read distance		100 mm
Depth of focus		± 30 mm
Reading field		120 mm x 80 mm
Ambient light limit		100000 Lux

Release date: 2023-02-24 Date of issue: 2023-02-24 Filename: 285693-100002\_eng.pdf

Refer to "General Notes Relating to Pepperl+Fuchs Product Information".

Pepperl+Fuchs Group  
www.pepperl-fuchs.com

USA: +1 330 486 0001  
fa-info@us.pepperl-fuchs.com

Germany: +49 621 776 1111  
fa-info@de.pepperl-fuchs.com

Singapore: +65 6779 9091  
fa-info@sg.pepperl-fuchs.com

**pf** PEPPERL+FUCHS

## Technical Data

Accuracy		± 0.2 mm
<b>Nominal ratings</b>		
Camera		
Type		CMOS , Global shutter
Processor		
Clock pulse frequency		600 MHz
Speed of computation		4800 MIPS
<b>Functional safety related parameters</b>		
MTTF <sub>d</sub>		83 a
Mission Time (T <sub>M</sub> )		10 a
Diagnostic Coverage (DC)		0 %
<b>Indicators/operating means</b>		
LED indication		7 LEDs (communication, alignment aid, status information)
<b>Electrical specifications</b>		
Operating voltage	U <sub>B</sub>	24 V DC ± 15% , PELV
No-load supply current	I <sub>0</sub>	max. 400 mA
Power consumption	P <sub>0</sub>	6 W
<b>Interface</b>		
Interface type		CANopen , galvanically isolated
Data output code		binary code
Transfer rate		max. 1 MBit/s
<b>Interface 2</b>		
Interface type		USB Service
<b>Input</b>		
Input type		1 function input 0-level: -U <sub>B</sub> or unwired 1-level: +8 V ... +U <sub>B</sub> , programmable
Input impedance		≥ 27 kΩ
<b>Output</b>		
Output type		1 to 3 switch outputs , programmable , short-circuit protected
Switching voltage		Operating voltage
Switching current		150 mA each output
<b>Standard conformity</b>		
Emitted interference		EN 61000-6-4:2007+A1:2011
Noise immunity		EN 61000-6-2:2005
Shock resistance		EN 60068-2-27:2009
Vibration resistance		EN 60068-2-6:2008
<b>Approvals and certificates</b>		
UL approval		cULus Listed, General Purpose, Class 2 Power Source, Type 1 enclosure
CCC approval		CCC approval / marking not required for products rated ≤36 V
<b>Ambient conditions</b>		
Operating temperature		0 ... 60 °C (32 ... 140 °F) , -20 ... 60 °C (-4 ... 140 °F) (noncondensing; prevent icing on the lens!)
Relative humidity		90 % , noncondensing
<b>Mechanical specifications</b>		
Connection type		8-pin, M12x1 connector, standard (supply+IO) 5-pin, M12x1 socket, A-coded (bus out/termination) 5-pin, M12x1 connector, A-coded (bus in)
Housing width		70 mm
Housing height		70 mm
Housing depth		50 mm
Degree of protection		IP67
Material		
Housing		PC/ABS
Mass		approx. 200 g

Release date: 2023-02-24 Date of issue: 2023-02-24 Filename: 285693-100002\_eng.pdf

Refer to "General Notes Relating to Pepperl+Fuchs Product Information".

Pepperl+Fuchs Group  
www.pepperl-fuchs.comUSA: +1 330 486 0001  
fa-info@us.pepperl-fuchs.comGermany: +49 621 776 1111  
fa-info@de.pepperl-fuchs.comSingapore: +65 6779 9091  
fa-info@sg.pepperl-fuchs.com

**PEPPERL+FUCHS**

## Technical Data

### Factory settings

X resolution (protocol)	0.1 mm
Y resolution (protocol)	0.1 mm
Speed resolution (protocol)	0.1 m/s
Angle resolution	0.1 °
Baud rate	500 kBit/s
Extrapolation	On
Read head address	3

## Connection

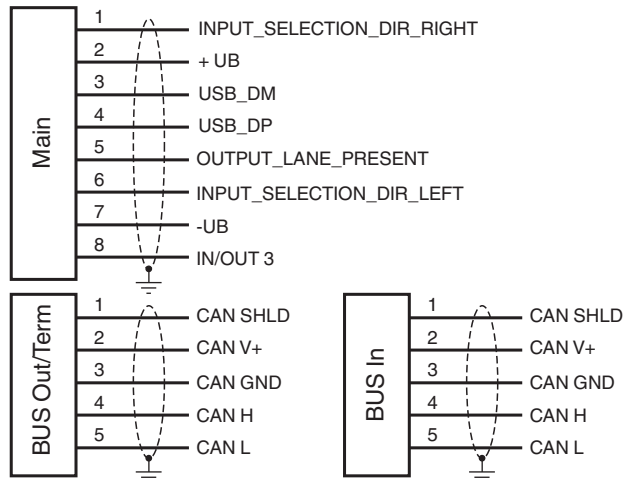

## Connection Assignment

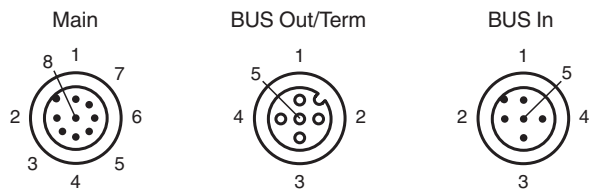

## Function Principle

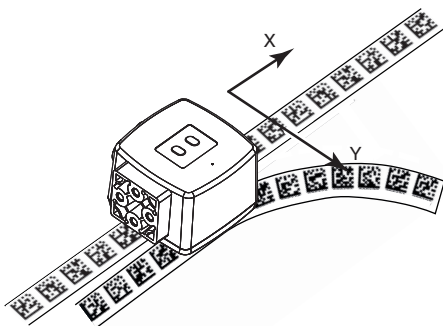

Release date: 2023-02-24 Date of issue: 2023-02-24 Filename: 285693-100002\_eng.pdf



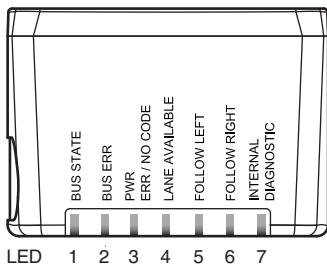
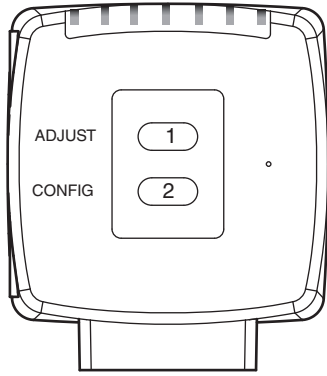

## Function Principle



## Matching System Components





	<b>PGV*-CA25-*</b>	Data Matrix code tape
	<b>PGV*-CC25-*</b>	Control code tape für PGV System
	<b>PGV85-CT4</b>	Data Matrix tag for PGV system
	<b>PGV25M-CD100-CLEAR</b>	Protective laminate for PGV code tape
	<b>PGV25M-CD160-CLEAR</b>	Protective laminate for PGV code tape

## Accessories

	<b>PCV-SC12</b>	Grounding clip for PCV system
	<b>PCV-LM25</b>	Marker head for 25 mm code tape
	<b>PCV-MB1</b>	Mounting bracket for PCV* read head
	<b>V19-G-2M-PUR-ABG</b>	Female cordset single-ended M12 straight A-coded, 8-pin, PUR cable grey, shielded
	<b>V19-G-5M-PUR-ABG</b>	Female cordset single-ended M12 straight A-coded, 8-pin, PUR cable grey, shielded

Release date: 2023-02-24 Date of issue: 2023-02-24 Filename: 285693-100002\_eng.pdf

## Accessories

	<b>Vision Configurator</b>	Operating software for camera-based sensors
	<b>PCV-KBL-V19-STR-USB</b>	USB cable unit with power supply
	<b>PGV25M-CD120-CLEAR</b>	Protective laminate for PGV code tape
	<b>VAZ-V1S-B</b>	Blind plug for M12 sockets

## Additional Information

### General

The PGV... reader forms part of the positioning system in the Pepperl+Fuchs incident light process. The read head's features include a camera module and an integrated illumination unit. The reader uses these features to detect a colored strip stuck to the floor to track the lane. The reader also detects control codes and position markers in the form of Data Matrix codes attached to a self-adhesive code tape. The Data Matrix code tape is usually mounted in a fixed position instead of the colored strip or parallel to the colored strip. The reader is located on the front of an automated guided vehicle and guides this vehicle along the colored strip and/or Data Matrix code tape.

### Mounting and Commissioning

Mount the reader such that the optical surface of the device captures the optimum reading distance to the colored strip and/or Data Matrix code tape (see "Technical Data"). The stability of the mounting and the manner in which the vehicle is guided ensure that the reader is not operated outside of its depth of focus range. The colored strip and/or Data Matrix code tape must not leave the maximum reading window for the reader during this process.

All readers can be adapted to optimally meet specific requirements through parameterization.

### Displays and Local Controls

The PGV... reader is equipped with seven indicator LEDs for carrying out visual function checks and rapid diagnosis. The reader is equipped with two buttons at the back for activating the alignment aid and parameterization mode.

### LEDs

LED	Color	Label	Meaning
1	Yellow	BUS STATE	CANopen communication active
2	Red	BUS ERR	CANopen communication error
3	Green/red	PWR ERR/NO CODE	Code detected/not detected, error
4	Yellow	LANE AVAILABLE	Lane available
5	Yellow	FOLLOW LEFT	"Follow left-hand lane" activated
6	Yellow	FOLLOW RIGHT	"Follow right-hand lane" activated
7	Red/green/yellow	INTERNAL DIAGNOSTIC	Internal diagnostics

### External Parameterization

To parameterize the device externally, the parameterization code is required in the form of a Data Matrix containing the desired reader parameters. Data Matrix code cards detailing the step-by-step process for externally parameterizing the device are printed in the instruction manual for the reader.

The reader can be parameterized only within ten minutes of being switched on. If a key is pressed after ten minutes of the device being switched on, a visual signal is given by the LEDs (LED1, yellow/LED2, red/LED3, green/LED4, yellow/LED5, yellow/LED6, yellow, flashing for two seconds).

- The switchover from normal mode to parameterization mode is made by pressing button 2 on the back of the reader. To switch the device over, button 2 must be pressed and held for more than two seconds. LED4 then flashes.  
**Note:** Parameterization mode is exited automatically if the device is inactive for one minute. In this case, the reader reverts to normal mode and operates without the settings having been changed.
- Place the parameterization code in the field of vision of the camera module. After the parameterization code is detected, the green LED3 lights up for one second. If the parameterization code is invalid, LED3 lights up in red for two seconds.
- Briefly pressing button 2 will exit parameterization mode.