

AS-Interface I/O module

VBA-4E3A-G20-ZEL/E2L-P5

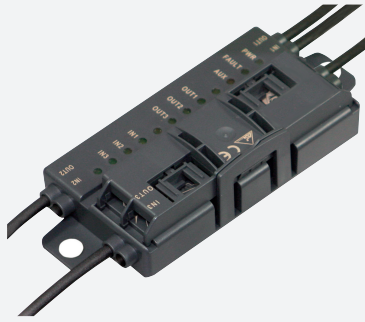

- A/B node with extended addressing possibility for up to 62 nodes
- Inputs for 3-wire sensors
- Power supply of the inputs and outputs from the external auxiliary voltage
- Communication monitoring
- Function display for bus, external auxiliary voltage, in- and outputs
- Cable piercing method with gold plated contact pins
- M12 connection, e.g., suitable for Lenze Smart Motor drives and SEW MOVI-SWITCH

G20 module for digital inputs/outputs, 4 inputs and 3 outputs



Function

The AS-Interface I/O module VBA-4E3A-G20-ZEL/E2L-P* is a field module with 4 inputs for 3-wire sensors and 3 electronic outputs. The outputs are overload and short-circuit protected. The compact housing can be installed directly in support profiles or conduits. The connection to the AS-Interface network and power supply is made using the AS-Interface flat cable and insulation piercing technology. The pivoted flat cable guide is secured using a snap-fit. No tools are required. The inputs and outputs are connected via cable outputs with M12 round plug connectors. Power for the inputs and outputs is provided by the external auxiliary voltage UAUX. The current switching state of the inputs and outputs is indicated by the IN and OUT LEDs. The PWR and FAULT LEDs indicate the status of the AS-Interface (normal operation, communication error, peripheral fault, address 0). The AUX LED indicates the external power supply.

Notes:

The communication monitor of the module deactivates the outputs if the AS-Interface does not communicate with the module for more than 40 ms. A signal indicating an overload of the outputs or the input supply or the absence of the external auxiliary voltage is also transmitted to the AS-Interface master via the 'peripheral fault' function. Communication via the AS-Interface continues.

Dimensions

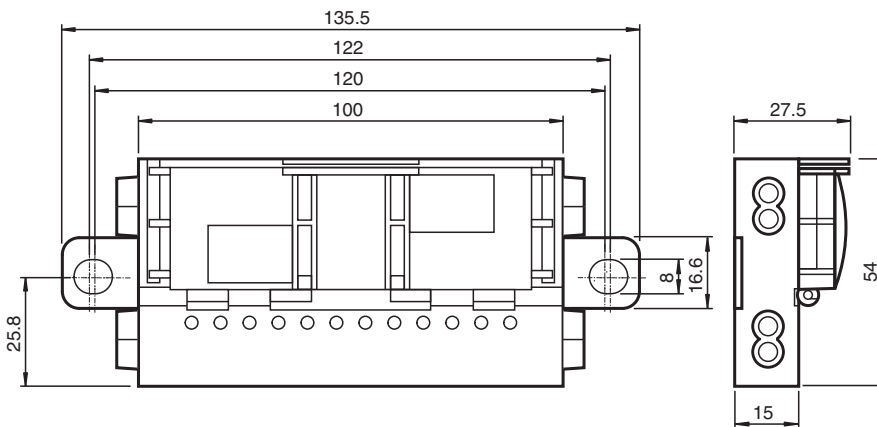

Technical Data

General specifications

Node type	A/B node
AS-Interface specification	V3.0
Required gateway specification	≥ V2.1
Profile	S-7.A.E
IO code	7

Release date: 2021-05-04 Date of issue: 2021-05-04 Filename: 70123995_eng.pdf

Refer to "General Notes Relating to Pepperl+Fuchs Product Information".

Technical Data

ID code		A
ID1 code		7
ID2 code		E
UL File Number		E223772 "For use in NFPA 79 Applications only"
MTBF		110 a
Indicators/operating means		
LED FAULT		error display; LED red red: communication error or address is 0 red flashing: overload of sensor power supply or overload of outputs or external auxiliary voltage U_{AUX} missing
LED PWR		AS-Interface voltage; green LED green: voltage OK flashing green: address 0 or overload of sensor power supply or overload of outputs or external auxiliary voltage U_{AUX} missing
LED AUX		ext. auxiliary voltage U_{AUX} ; dual LED green/red green: voltage OK red: reverse voltage
LED IN		switching state (input); 4 LED yellow
LED OUT		Switching state (output); 3 LED yellow
Electrical specifications		
Auxiliary voltage (output)	U_{AUX}	20 ... 30 V DC PELV
Rated operating voltage	U_e	26.5 ... 31.6 V from AS-Interface
Rated operating current	I_e	≤ 35 mA
Input		
Number/Type		4 Inputs for 3-wire sensors (PNP), DC
Supply		from external auxiliary voltage U_{AUX}
Current loading capacity		500 mA , overload and short-circuit protected
Input current		≤ 8 mA (limited internally)
Switching point		according to DIN EN 61131-2 0 (undamped) ≤ 0.5 mA 1 (damped) ≥ 2.0 mA
Signal delay		< 1 ms (input/AS-Interface)
Output		
Number/Type		3 electronic outputs, PNP, overload and short-circuit proof
Supply		from external auxiliary voltage U_{AUX}
Voltage		≥ ($U_{AUX} - 0.5$ V)
Current		2 A per output TB ≤ 40 °C: 6 A total TB ≤ 60 °C: OUT1+OUT2 max. 3 A, OUT3 max. 2 A
Directive conformity		
Electromagnetic compatibility		
Directive 2014/30/EU		EN 62026-2:2013
Standard conformity		
Degree of protection		EN 60529:2000
Fieldbus standard		EN 62026-2:2013
Input		EN 61131-2:2007
Emitted interference		EN 61000-6-4:2007
AS-Interface		EN 62026-2:2013
Noise immunity		EN 61000-6-2:2005, EN 61326-1:2006, EN 62026-2:2013
Ambient conditions		
Ambient temperature		-25 ... 60 °C (-13 ... 140 °F)
Storage temperature		-25 ... 85 °C (-13 ... 185 °F)
Mechanical specifications		
Degree of protection		IP54 according to EN 60529

Release date: 2021-05-04 Date of issue: 2021-05-04 Filename: 70123995_eng.pdf

Technical Data

Connection	<p>AS-Interface, AUX: Insulation piercing technology Yellow flat cable/black flat cable Inputs/outputs: M12 round plug connector in accordance with EN 61076-2-101 Inputs: LF type (4-pin, bushing contacts, screw lock, A-coded) Matching connector: LM type or similar Outputs: LF type (4-pin, bushing contacts, screw lock, A-coded) Matching connector: LM type or similar</p>
Mass	260 g
Mounting	2 clips with Ø 8 mm drill hole
Cable length	2 m
Note	The flat cable routing is designed for 100 actuation cycles

Connection

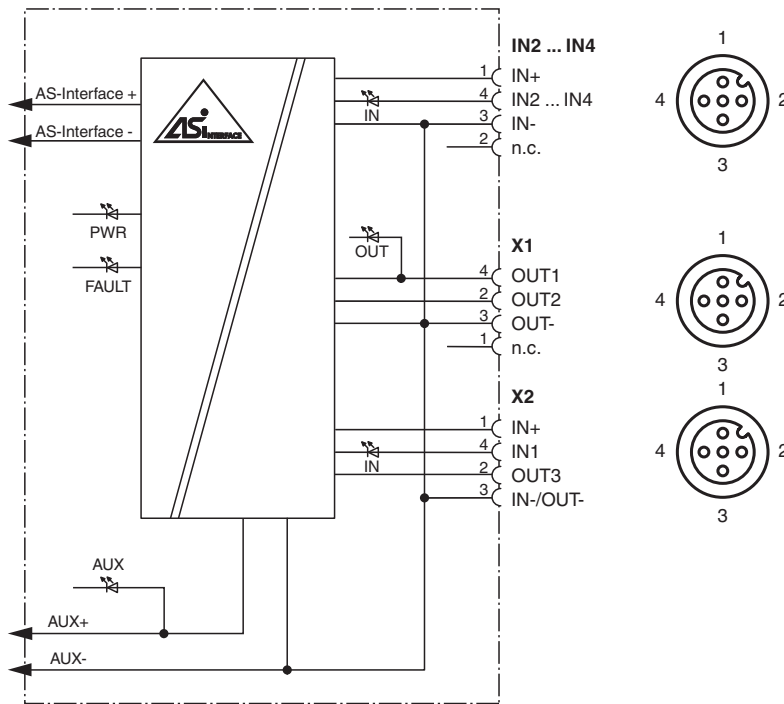

Assembly

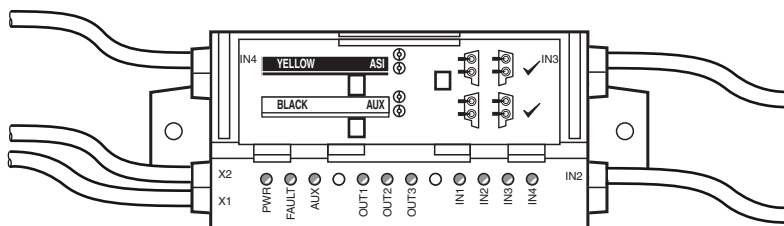

Programming

Data bits

Refer to "General Notes Relating to Pepperl+Fuchs Product Information".

Release date: 2021-05-04 Date of issue: 2021-05-04 Filename: 70123995_eng.pdf

(function via AS-Interface)



Data bits	Input	Output
D0	IN1	OUT1
D1	IN2	OUT2
D2	IN3	OUT3
D3	IN4	-

Parameter bit

(programmable via AS-Interface)

Parameter bit	Function	Description
P0	Communication monitoring	P0 = 0 monitoring = off, the outputs maintain the status if communication fails P0 = 1 monitoring = on, i.e. if communication fails, the outputs are deenergised (default settings)
P1	Input filter	P1 = 0 input filter on, pulse suppression ≤ 2 ms P1 = 1 input filter off (default settings)
P2	Synchronous mode	P2 = 0 synchronous mode on P2 = 1 synchronous mode off (default settings)

Accessories

	VBP-HH1-V3.0-KIT	AS-Interface Handheld with accessory
	VAZ-PK/G20-1M-V1-G	Adapter cable G20 module/hand-held programming device
	VAZ-G20-MH	Mounting aid