

Cable connector, NAMUR

V1-W-N4-5M-PUR-N4S

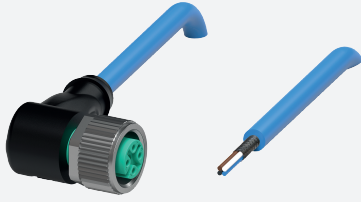

- Suitable for drag chains and abrasion resistant
- Suitable for NAMUR technology
- Degree of protection IP68 / IP69
- Free of paint wetting interfering substances
- Resistant to microbes and hydrolysis
- UV resistant
- Oil resistant
- UL listed for USA and Canada
- Halogen-free
- Specific design protects against loosening and inaccurate installation

Female cordset single-ended M12 angled A-coded, 4-pin, PUR cable blue, NAMUR, shielded, UL approved, drag chain suitable, oil resistant



Dimensions

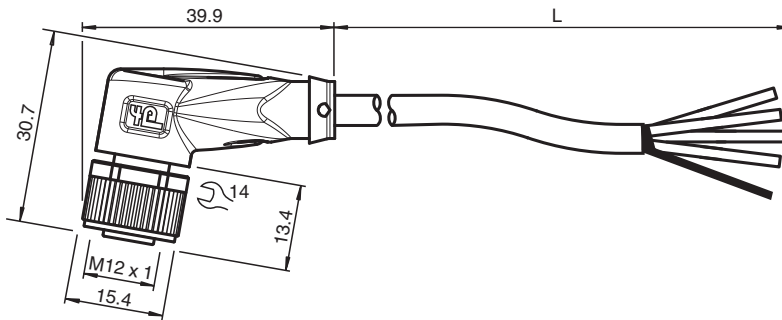

Technical Data

General specifications

Connector 1	
Connection	socket
Construction type	M12
Style	angled
Locking	screw connection
Number of pins	4
Coding	A-coded
Connector 2	
Connection	cable end

Electrical specifications

Operating voltage	U_B	max. 250 V AC/DC
Operating current	I_B	4 A
Resistance per unit length	R'	max. 0.039 Ω/m
Capacitance per unit length	C'	57.3 nF/km
Inductance per unit length	L'	0.758 mH/km

Conformity

Degree of protection	EN 60529
Plug connection	connector M12 x 1 : IEC 61076-2-101

Release date: 2023-09-04 Date of issue: 2023-09-04 Filename: 70165812_eng.pdf

Refer to "General Notes Relating to Pepperl+Fuchs Product Information".

Pepperl+Fuchs Group
www.pepperl-fuchs.com

USA: +1 330 486 0001
fa-info@us.pepperl-fuchs.com

Germany: +49 621 776 1111
fa-info@de.pepperl-fuchs.com

Singapore: +65 6779 9091
fa-info@sg.pepperl-fuchs.com

PF PEPPERL+FUCHS

Technical Data

Flammability		UL 758 / 1581 , DIN EN 60332-1-2
Halogen-free		DIN VDE 0472-815 , IEC 60754-1
Microbial resistance		EN 50363
Hydrolysis resistance		EN 50363
Oil resistance		DIN EN 60811-404
Approvals and certificates		
UL approval		AWM STYLE 20549/10152 80°C 300V FT2 (cable)
UL File Number		E231213
Ambient conditions		
Ambient temperature		
Plug connector		-40 ... 90 °C (-40 ... 194 °F)
Cable, fixed		-40 ... 80 °C (-40 ... 176 °F)
Cable, flexing		-25 ... 80 °C (-13 ... 176 °F)
Pollution degree		3
Mechanical specifications		
Plug connector		
Tightening torque		0.6 Nm
Loosening protection		available
Tool installation		straight knurling and hexagon nut SW = 14 mm
Mating cycles		min. 100
Shielding		shield connected to screw connection
Degree of protection		IP68 / IP69
Cable		according to IEC/EN 60228 (DIN VDE 0295) class 6
Sheath diameter		6 mm
Bending radius		> 10 x cable diameter, moving > 5 x cable diameter, fixed
Sheath stripping force		max. 80 N / 300 mm
Sheath color		blue (similar to RAL 5015)
Number of cores		4
Core cross section		0.5 mm ²
Cores color		Core 1: brown Core 2: white Core 3: blue Core 4: black
Core construction		28 x 0.15 mm Ø
Shield		tinned copper braiding, 85 % coverage
Length	L	5 m
Cable code		Li 9Y C11Y 4 x 0,50
Drag chain suitability		
Drag chain cycles		min. 2000000
Motion velocity		max. 3 m/s
Traverse distance		max. 10 m
Acceleration		max. 10 m/s ²
Material		
PWIS free		yes
Halogen-free		yes
Plug connector		
Screw connection		Zinc diecast, nickel-plated
Body		TPU, black
Seal		FKM
Contact surface		gold plated (Au)
Flammability		V-2
Cable		
Sheathing		PUR based on polyether

Release date: 2023-09-04 Date of issue: 2023-09-04 Filename: 70165812_eng.pdf

Refer to "General Notes Relating to Pepperl+Fuchs Product Information".

Pepperl+Fuchs Group
www.pepperl-fuchs.comUSA: +1 330 486 0001
fa-info@us.pepperl-fuchs.comGermany: +49 621 776 1111
fa-info@de.pepperl-fuchs.comSingapore: +65 6779 9091
fa-info@sg.pepperl-fuchs.com

PEPPERL+FUCHS





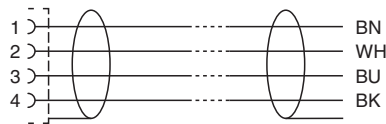
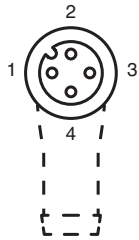

Technical Data

Core insulation	PP
UV resistance	yes
Chemical resistance	good
Oil resistance	yes
Microbial resistance	yes
Hydrolysis resistance	yes
Flammability	FT2

Connection



Accessories

	MH V1-SCREWDRIVER	Torque screwdriver (0.6 Nm)
	MH V1-BIT M12	plug-in cap M12
	V1/V3-LABELHOLDER	Label holder
	V1/V3-LABEL	Label plate
	MH V1-Holder	Modular universal holder for M12 connectors
	V1-CLIP	Unlocking protector for M12 connector
	V1-MARKING-RING-COLOR	Marking rings for M12 connectors, various colors

Release date: 2023-09-04 Date of issue: 2023-09-04 Filename: 70165812_eng.pdf