

Valve Connector Cordset VMC-2+P/Z2-2M-PUR-V1-G

- Valve connector according EN 175301-803 A/ISO 4400
- Z diode as a protective circuit
- Built-in LED, as operating and function indicator
- Moulded seal
- freely selectable cable models due to bridged protective earth
- Flame resistant cable
- Suitable for drag chains and abrasion resistant
- Halogen-free

Valve connector Form C, Z-diode LED 2-pin+PE to M12 plug straight A-coded 3-pin, PUR cable black, drag chain suitable



Dimensions

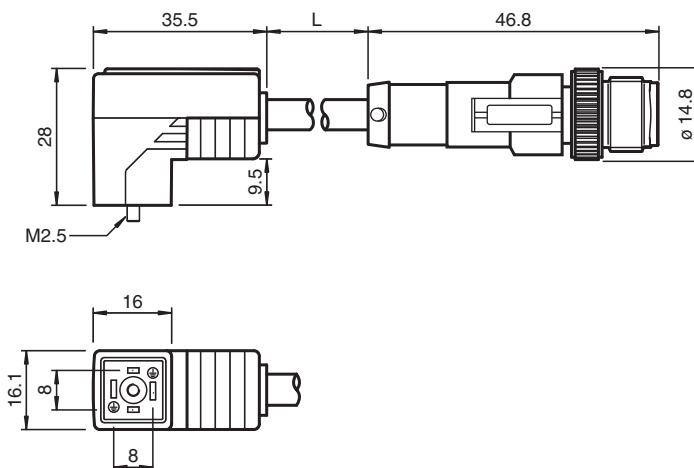

Technical Data

General specifications	
Connector 1	
Connection	Valve connector DIN
Construction type	form C
Style	angled
Locking	screw connection
Number of pins	2 + PE
Connector 2	
Connection	plug
Construction type	M12
Style	straight
Locking	screw connection
Number of pins	3
Coding	A-coded
Indicators/operating means	
LED yellow	Operating display

Release date: 2023-07-05 Date of issue: 2023-07-05 Filename: 456889_eng.pdf

Refer to "General Notes Relating to Pepperl+Fuchs Product Information".

Pepperl+Fuchs Group
www.pepperl-fuchs.com

USA: +1 330 486 0001
fa-info@us.pepperl-fuchs.com

Germany: +49 621 776 1111
fa-info@de.pepperl-fuchs.com

Singapore: +65 6779 9091
fa-info@sg.pepperl-fuchs.com

PEPPERL+FUCHS

Technical Data

Electrical specifications		
Operating voltage	U _B	24 V AC/DC
Operating current	I _B	max. 4 A
Suppression		Zener diode
Conformity		
Degree of protection		EN 60529
Plug connection		Valve connector : DIN EN 175301-803
Flammability		DIN VDE 0482 , DIN EN 50265-2-1 , UL 94
Halogen-free		DIN VDE 0472-815
UV resistance		DIN EN ISO 4892-2-A
Oil resistance		DIN EN 60811-2-1
Ambient conditions		
Ambient temperature		
Connector 1		-20 ... 85 °C (-4 ... 185 °F)
Connector 2		-25 ... 90 °C (-13 ... 194 °F)
Cable, fixed		-40 ... 80 °C (-40 ... 176 °F)
Cable, flexing		-20 ... 80 °C (-4 ... 176 °F)
Pollution degree		3
Mechanical specifications		
Connector 1		
Tightening torque		0.6 Nm
Tool installation		screw M2.5 x 27.5
Mating cycles		min. 100
Connector 2		
Tightening torque		0.6 Nm
Tool installation		straight knurling
Mating cycles		min. 100
Degree of protection		IP65/IP67
Cable		
Sheath diameter		4.5 mm
Bending radius		> 50 mm > 22.5 mm, fixed
Sheath color		dark grey (RAL 7021)
Number of cores		3
Core cross section		0.5 mm ²
Cores color		Core 1: black 1 Core 2: black 2 Core 3: green/yellow
Core construction		28 x 0.15 mm Ø
Length	L	2 m
Cable code		Li 9Y 11Y 3 x 0,50
Drag chain suitability		
Drag chain cycles		min. 15000000
Motion velocity		max. 5 m/s
Traverse distance		0.9 m
Acceleration		max. 30 m/s ²
Material		
Halogen-free		yes
Connector 1		
Screw connection		TPU, black
Body		TPU , molded
Contact surface		Sn
Flammability		V-0
Connector 2		

Release date: 2023-07-05 Date of issue: 2023-07-05 Filename: 456889_eng.pdf

Technical Data

Screw connection	Zinc diecast, nickel-plated
Body	TPU, black
Contact surface	Ni/Au
Flammability	HB
Cable	
Sheathing	PUR
Core insulation	PP
UV resistance	yes
Oil resistance	good
Flammability	V-0

Connection

