



# Optical reader - safePGV

## PGV100A-F200A-B28-V1D

- SIL 3 (EN 61508)
- Category 4 PL e (EN ISO 13849)
- PROFINET interface
- PROFIsafe interface
- Safe, non-contact positioning on Data Matrix code tape
- Traverse distance up to 100 km
- Mechanically rugged: no wearing parts, long operating life, maintenance-free

Read head for incident light positioning system



### Dimensions

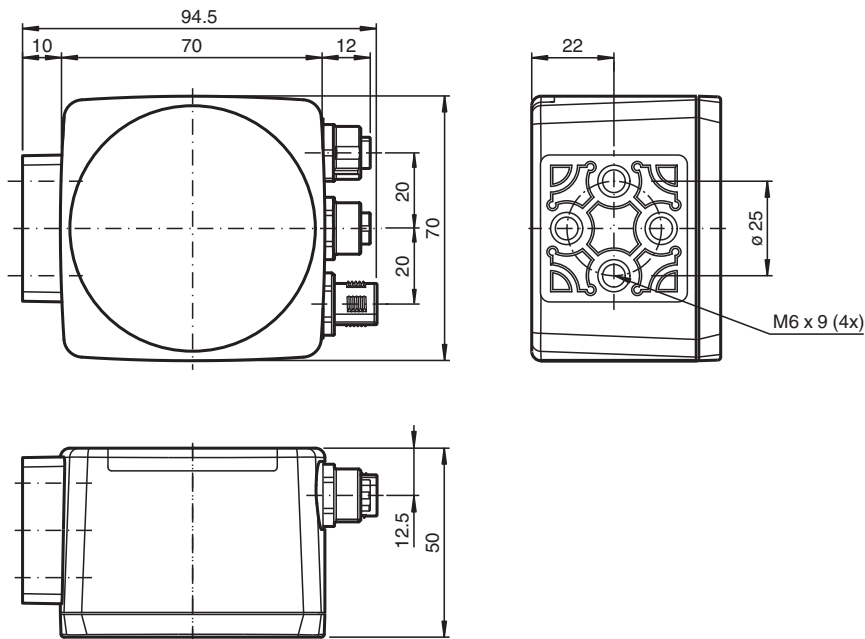

### Technical Data

#### General specifications

Passage speed	v	≤ 8 m/s
Measuring range		max. 100000 m
Light type		Integrated LED lightning (red/blue)
Read distance		100 mm
Depth of focus		± 30 mm
Field of view		typ. 120 mm x 80 mm
Ambient light limit		30000 Lux
Accuracy		
Non safety-related X, Y		± 0.2 mm

Release date: 2023-07-10 Date of issue: 2023-07-10 Filename: 303883\_eng.pdf

Refer to "General Notes Relating to Pepperl+Fuchs Product Information".

Pepperl+Fuchs Group  
www.pepperl-fuchs.com

USA: +1 330 486 0001  
fa-info@us.pepperl-fuchs.com

Germany: +49 621 776 1111  
fa-info@de.pepperl-fuchs.com

Singapore: +65 6779 9091  
fa-info@sg.pepperl-fuchs.com

**PF** PEPPERL+FUCHS

## Technical Data

Non safety-related angle $\alpha$		$\pm 0.5^\circ$
Safety-related X		See the original instructions
<b>Nominal ratings</b>		
Camera		
Type		CMOS , Global shutter
Processor		
Clock pulse frequency		600 MHz
Speed of computation		4800 MIPS
<b>Functional safety related parameters</b>		
Safety Integrity Level (SIL)		SIL 3
Performance level (PL)		PL e
Category		Cat. 4
Reaction time		165 ms
MTTF		41 a
MTTF <sub>d</sub>		104.74 a
Mission Time (T <sub>M</sub> )		20 a
PFH		1.09 E-8 typ.
<b>Indicators/operating means</b>		
LED indication		7 LEDs (communication, status messages)
<b>Electrical specifications</b>		
Operating voltage	U <sub>B</sub>	20 ... 30 V DC , PELV
No-load supply current	I <sub>0</sub>	max. 300 mA
Power consumption	P <sub>0</sub>	6 W
<b>Interface</b>		
Interface type		100 BASE-TX
Protocol		PROFINET IO Real-Time (RT) Conformance class B
Transfer rate		100 MBit/s
<b>Conformity</b>		
Fieldbus standard		PROFIsafe in accordance with IEC 61784-3-3; profile 2.4
Functional safety		EN ISO 13849-1:2015 ; EN 61508:2010 part 1-7 ; EN 62061:2005 + AC:2010 + A1:2013 + A2:2015
Shock resistance		EN 60068-2-27:2009
Vibration resistance		EN 60068-2-6:2008
Emitted interference		EN 61000-6-4:2007+A1:2011
Noise immunity		EN 61000-6-7:2015
Photobiological safety		Risk group 2 according to IEC 62471
<b>Approvals and certificates</b>		
CE conformity		CE
UL approval		cULus Listed, Class 2 Power Source, Type 1 enclosure
CCC approval		CCC approval / marking not required for products rated $\leq 36$ V
TÜV approval		TÜV Rheinland 01/205/5669.01/20
<b>Ambient conditions</b>		
Operating temperature		0 ... 45 °C (32 ... 113 °F) , -20 ... 45 °C (-4 ... 113 °F) (noncondensing; prevent icing on the lens!)
Storage temperature		-40 ... 85 °C (-40 ... 185 °F)
Relative humidity		90 % , noncondensing
Altitude		max. 2000 m above MSL
<b>Mechanical specifications</b>		
Connection type		8-pin, M12x1 connector, standard 4-pin, M12x1 socket, D-coded (LAN) 4-pin, M12x1 socket, D-coded (LAN)
Housing width		70 mm
Housing height		70 mm
Housing depth		50 mm

Release date: 2023-07-10 Date of issue: 2023-07-10 Filename: 303883\_eng.pdf

### Technical Data

Degree of protection	IP67
Material	
Housing	PC/ABS
Mass	approx. 200 g

### Connection

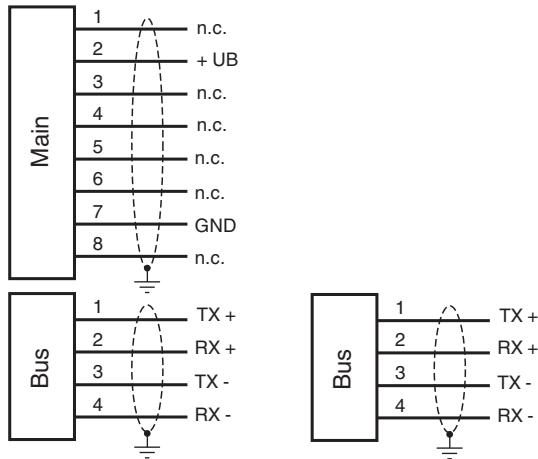

### Connection Assignment

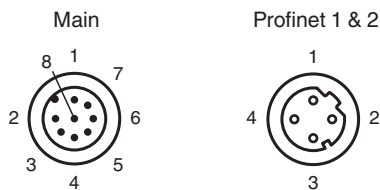

### Characteristic Curve

#### Position Data

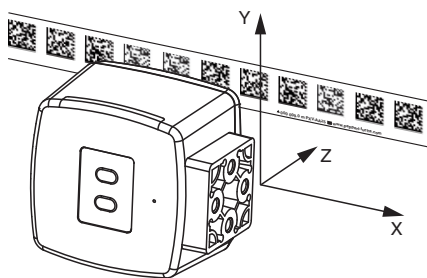



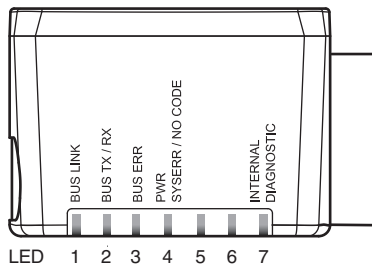
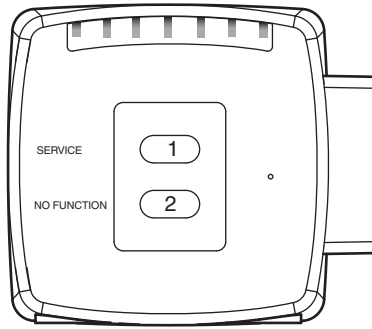

Release date: 2023-07-10 Date of issue: 2023-07-10 Filename: 303883\_eng.pdf







## Characteristic Curve



## Matching System Components



	<b>PXV*-AA25-*</b>	Data Matrix code tape
	<b>VAZ-V1S-B</b>	Blind plug for M12 sockets
	<b>PGV25M-CD100-CLEAR</b>	Protective laminate for PGV code tape
	<b>PGV25M-CD160-CLEAR</b>	Protective laminate for PGV code tape

## Accessories

	<b>PCV-AG100</b>	Alignment guide for PCV100-* read head
	<b>PCV-SC12</b>	Grounding clip for PCV system
	<b>PCV-SC12A</b>	Grounding clip for PCV system
	<b>PCV-LM25</b>	Marker head for 25 mm code tape
	<b>PCV-MB1</b>	Mounting bracket for PCV* read head
	<b>V19-G-ABG-PG9</b>	Female connector M12 straight A-coded 8-pin, for cable diameter 5 - 8 mm, shielded, field-attachable

Release date: 2023-07-10 Date of issue: 2023-07-10 Filename: 303883\_eng.pdf

## Accessories

	<b>V19-G-ABG-PG9-FE</b>	Female connector, M12, 8-pin, shielded, field attachable
	<b>V19-G-2M-PUR-ABG</b>	Female cordset single-ended M12 straight A-coded, 8-pin, PUR cable grey, shielded
	<b>V19-G-5M-PUR-ABG</b>	Female cordset single-ended M12 straight A-coded, 8-pin, PUR cable grey, shielded

## Additional Information

### Function

The reader forms part of the positioning system in the Pepperl+Fuchs incident light process, working with stationary Data Matrix code tapes mounted on the ground. The device's features include a camera module with an internal illumination unit, which follows a stationary Data Matrix code tape affixed to the ground in parallel in order to reliably detect the position. The device can be used in all applications where automated guided vehicles (AGV) are to be positioned precisely at marked positions along a given spur.

The positioning system issues position values that achieve the reliability required by SIL 3 and PL e, provided that the device is properly integrated into the plant according to the specifications given in the original instructions.

### Mounting and Commissioning

Mount the reader such that the optical surface of the device captures the optimal reading distance to the Data Matrix code tape (see "Technical Data"). The stability of the mounting and the manner in which the vehicle is guided ensure that the reader is not operated outside of its depth of focus range. The code tape must not leave the maximum reading window for the reader during this process.

### Displays and Operating Elements

The reader is equipped with the following indicator LEDs for carrying out visual function checks and quick diagnostics:

#### LEDs

LED	Color	Label	Meaning
1	Green	BUS LINK	PROFINET connection activated
2	Yellow	BUS TX/RX	Data transfer
3	Red	BUS ERR	PROFINET communication error
4	Red/green	PWR SYSERR/NO CODE	Code detected/not detected, error
5	-	-	No function
6	-	-	No function
7	Red/green/yellow	INTERNAL DIAGNOSTIC	Internal diagnostics

The SERVICE button on the back of the device is used for internal service purposes.