



# RFID Transponder

## IPC03-58

- Battery-free data carrier
- 32 bit fixcode
- 928 bits memory available
- Degree of protection IP67
- Mounting holes for simple installation
- High resistance against water, chemicals, transformer oil, petrol and heating oil

Data carrier



### Dimensions

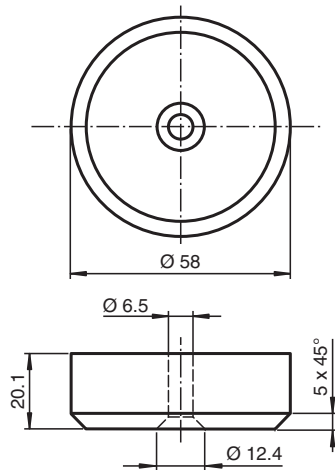

### Technical Data

<b>General specifications</b>	
Operating frequency	125 kHz
Transfer rate	2 kBit/s
<b>Memory</b>	
Chip Type	EM4450 Titan (EM Microelectronic)
EEPROM	928 Bit
Read cycles	unlimited
Write cycles	> 100000
Data retention period	10 years at 55 °C (131 °F)
<b>Directive conformity</b>	
Radio equipment	
Directive 2014/53/EU	EN 300330
RoHS	
Directive 2011/65/EU (RoHS)	IEC/EN 63000
<b>Standard conformity</b>	
Degree of protection	EN 60529
RFID	ISO/IEC 18000-2

Release date: 2022-12-15 Date of issue: 2022-12-15 Filename: 182162\_eng.pdf

Refer to "General Notes Relating to Pepperl+Fuchs Product Information".

**Technical Data**

<b>Ambient conditions</b>	
Ambient temperature	-25 ... 85 °C (-13 ... 185 °F)
Storage temperature	-25 ... 120 °C (-13 ... 248 °F)
<b>Mechanical specifications</b>	
Housing height	20.1 mm
Housing diameter	58 mm
Degree of protection	IP67
Material	
Housing	PA 6 (Polyamid)
Encapsulation compound	Polyurethane (PUR)
<b>Installation</b>	
On metal	yes
In air	yes
Construction type	Cylindrical

Reading range in air IPC03-58

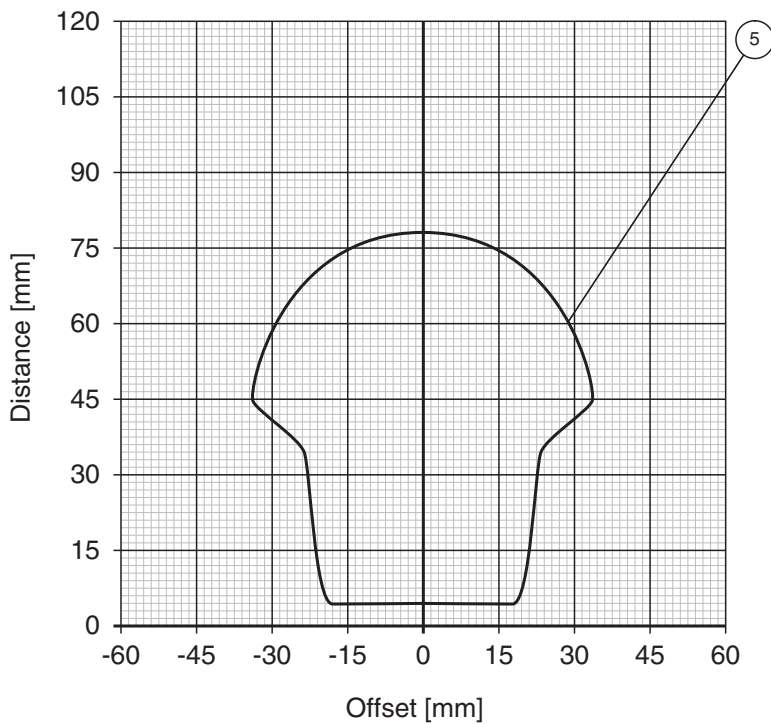

Release date: 2022-12-15 Date of issue: 2022-12-15 Filename: 182162\_eng.pdf

Refer to "General Notes Relating to Pepperl+Fuchs Product Information".

Writing range in air IPC03-58

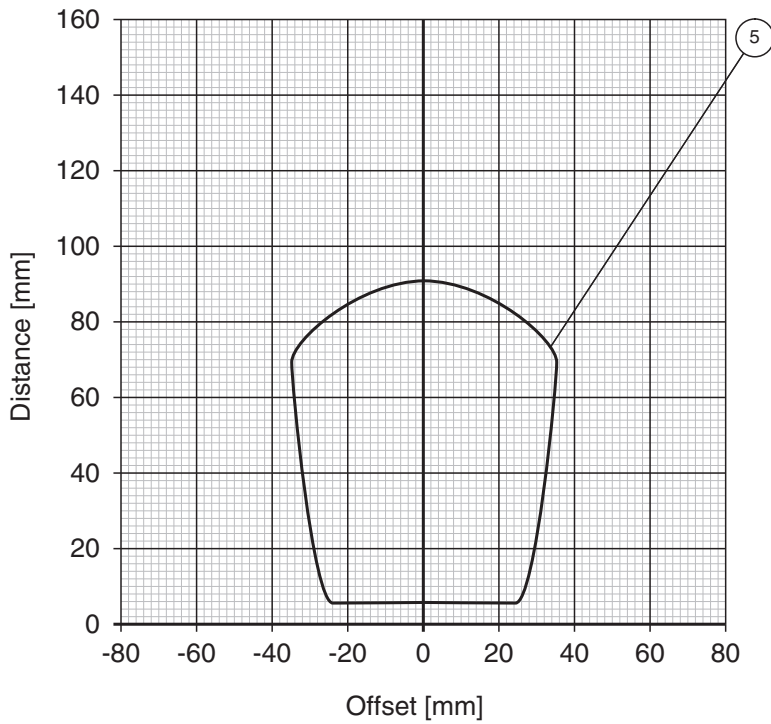

Release date: 2022-12-15 Date of issue: 2022-12-15 Filename: 182162\_eng.pdf

Refer to "General Notes Relating to Pepperl+Fuchs Product Information".

Pepperl+Fuchs Group  
www.pepperl-fuchs.com

USA: +1 330 486 0001  
fa-info@us.pepperl-fuchs.com

Germany: +49 621 776 1111  
fa-info@de.pepperl-fuchs.com

Singapore: +65 6779 9091  
fa-info@sg.pepperl-fuchs.com

Reading range on aluminium IPC03-58

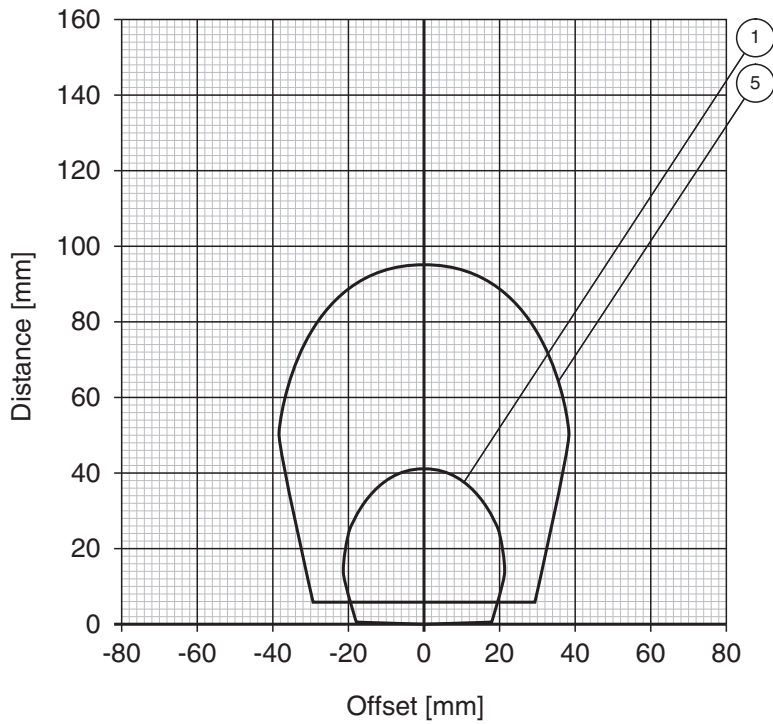

Release date: 2022-12-15 Date of issue: 2022-12-15 Filename: 182162\_eng.pdf

Refer to "General Notes Relating to Pepperl+Fuchs Product Information".

Pepperl+Fuchs Group  
www.pepperl-fuchs.com

USA: +1 330 486 0001  
fa-info@us.pepperl-fuchs.com

Germany: +49 621 776 1111  
fa-info@de.pepperl-fuchs.com

Singapore: +65 6779 9091  
fa-info@sg.pepperl-fuchs.com

Writing range on aluminium IPC03-58

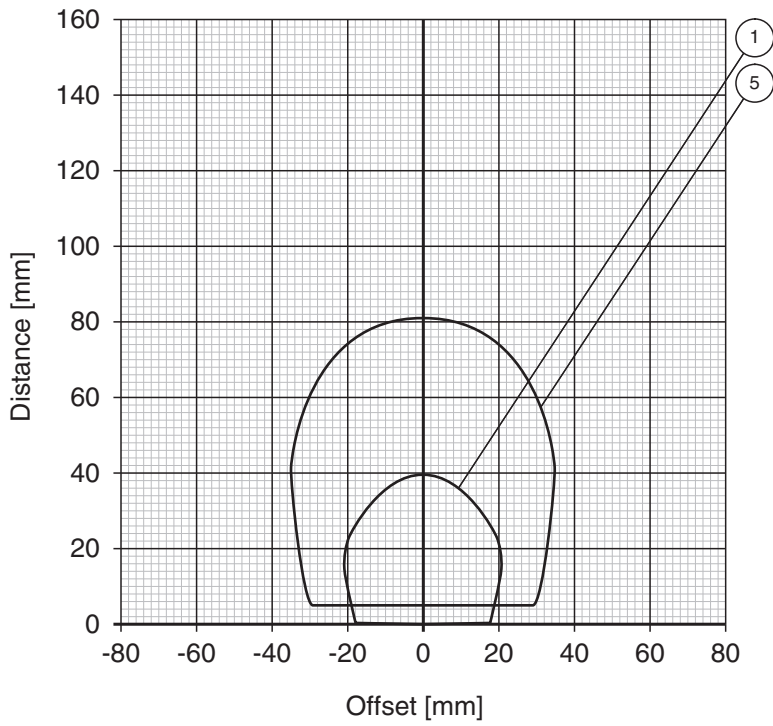

Release date: 2022-12-15 Date of issue: 2022-12-15 Filename: 182162\_eng.pdf

Refer to "General Notes Relating to Pepperl+Fuchs Product Information".

Pepperl+Fuchs Group  
www.pepperl-fuchs.com

USA: +1 330 486 0001  
fa-info@us.pepperl-fuchs.com

Germany: +49 621 776 1111  
fa-info@de.pepperl-fuchs.com

Singapore: +65 6779 9091  
fa-info@sg.pepperl-fuchs.com

Reading range on steel IPC03-58

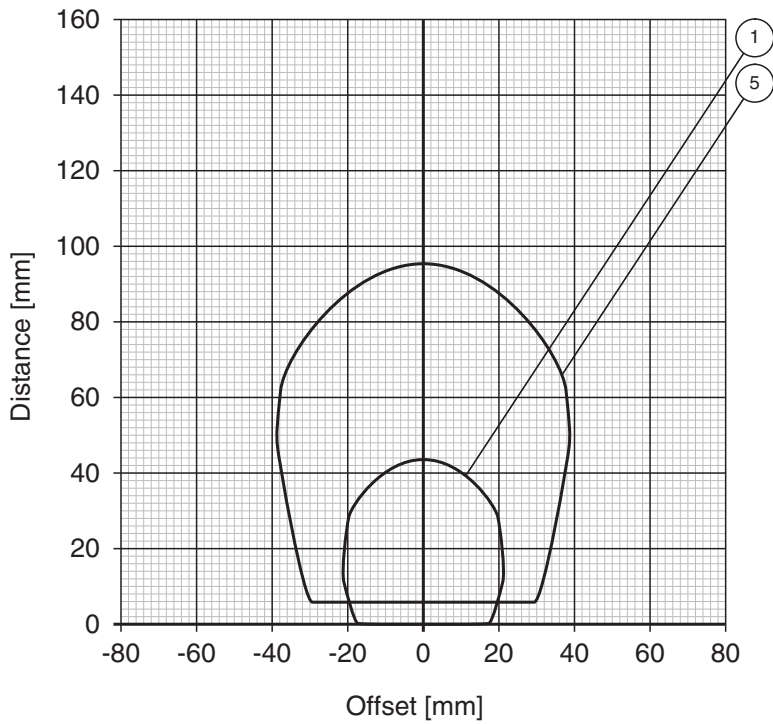

Release date: 2022-12-15 Date of issue: 2022-12-15 Filename: 182162\_eng.pdf

Refer to "General Notes Relating to Pepperl+Fuchs Product Information".

Pepperl+Fuchs Group  
www.pepperl-fuchs.com

USA: +1 330 486 0001  
fa-info@us.pepperl-fuchs.com

Germany: +49 621 776 1111  
fa-info@de.pepperl-fuchs.com

Singapore: +65 6779 9091  
fa-info@sg.pepperl-fuchs.com

**PF** PEPPERL+FUCHS

Writing range on steel IPC03-58

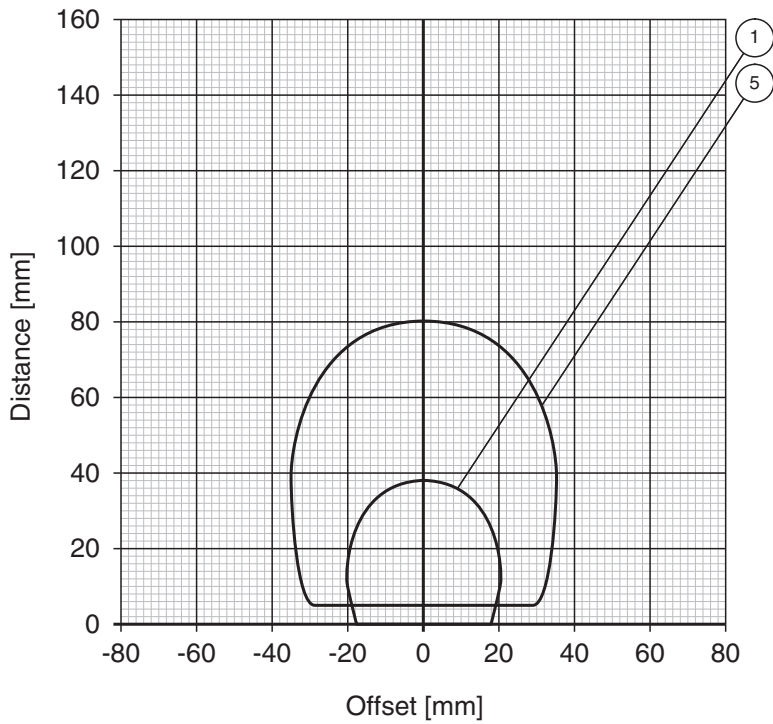

- |               |             |              |              |
|---------------|-------------|--------------|--------------|
| ① IPH-18GM-V1 | ③ IPH-F61   | ⑤ IPH-FP-V1  | ⑦ IPT1-FP-V1 |
| ② IPH-30GM-V1 | ④ IPH-L2-V1 | ⑥ IPH-F15-V1 |              |

Release date: 2022-12-15 Date of issue: 2022-12-15 Filename: 182162\_eng.pdf

Refer to "General Notes Relating to Pepperl+Fuchs Product Information".

Pepperl+Fuchs Group  
www.pepperl-fuchs.com

USA: +1 330 486 0001  
fa-info@us.pepperl-fuchs.com

Germany: +49 621 776 1111  
fa-info@de.pepperl-fuchs.com

Singapore: +65 6779 9091  
fa-info@sg.pepperl-fuchs.com

## Mounting

The surface containing the text must face the read/write head.

Release date: 2022-12-15 Date of issue: 2022-12-15 Filename: 182162\_eng.pdf

Refer to "General Notes Relating to Pepperl+Fuchs Product Information".

Pepperl+Fuchs Group  
www.pepperl-fuchs.com

USA: +1 330 486 0001  
fa-info@us.pepperl-fuchs.com

Germany: +49 621 776 1111  
fa-info@de.pepperl-fuchs.com

Singapore: +65 6779 9091  
fa-info@sg.pepperl-fuchs.com

 **PEPPERL+FUCHS**