

# Diffuse mode sensor OBD450-18GK40A-E0



- Short design in M18 plastic housing
- Operating distance adjustable
- Not sensitive to ambient light
- Degree of protection IP67
- High operating distance

## Diffuse mode sensor



## Function

The optical sensors of this series have an M18 threaded housing that is optionally available in plastic or metal. The sensors are robust and versatile. Focusing on the essential requirements simplifies selection and commissioning, saving time and costs.

## Dimensions

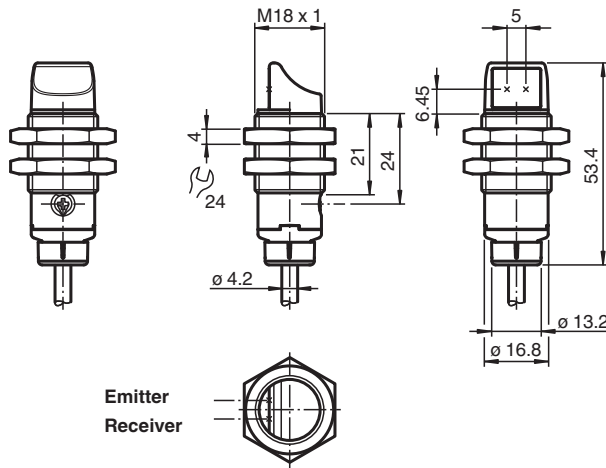

## Technical Data

General specifications	
Detection range	0 ... 450 mm
Detection range min.	0 ... 30 mm
Detection range max.	0 ... 450 mm
Adjustment range	30 ... 450 mm
Reference target	standard white 200 mm X 200 mm
Light source	LED
Light type	modulated visible red light
Diameter of the light spot	approx. 30 mm at 450 mm
Opening angle	approx. 2.6 °
Optical face	lateral
Ambient light limit	EN 60947-5-2 20000 Lux

Release date: 2022-05-12 Date of issue: 2022-05-12 Filename: 70113328-100090\_eng.pdf

Refer to "General Notes Relating to Pepperl+Fuchs Product Information".

Pepperl+Fuchs Group  
www.pepperl-fuchs.com

USA: +1 330 486 0001  
fa-info@us.pepperl-fuchs.com

Germany: +49 621 776 1111  
fa-info@de.pepperl-fuchs.com

Singapore: +65 6779 9091  
fa-info@sg.pepperl-fuchs.com

**PF** PEPPERL+FUCHS

## Technical Data

Hysteresis	H	< 15 %
<b>Functional safety related parameters</b>		
MTTF <sub>d</sub>		1289 a
Mission Time (T <sub>M</sub> )		20 a
Diagnostic Coverage (DC)		0 %
<b>Indicators/operating means</b>		
Operation indicator		LED green: on - power on flashing (4 Hz) - short circuit
Function indicator		LED yellow: constantly on - object detected constantly off - object not detected
Control elements		sensitivity adjustment
<b>Electrical specifications</b>		
Operating voltage	U <sub>B</sub>	10 ... 30 V DC
Ripple		max. 10 %
No-load supply current	I <sub>0</sub>	< 25 mA
Protection class		III
<b>Output</b>		
Switching type		Q - Pin4: NPN normally open / light-on
Signal output		1 NPN output, short-circuit protected, reverse polarity protected, open collector
Switching voltage		max. 30 V DC
Switching current		max. 100 mA , resistive load
Voltage drop	U <sub>d</sub>	≤ 1.5 V DC
Switching frequency	f	500 Hz
Response time		≤ 1 ms
<b>Conformity</b>		
Product standard		EN 60947-5-2
<b>Approvals and certificates</b>		
UL approval		E87056 , cULus Listed , class 2 power supply , type rating 1
<b>Ambient conditions</b>		
Ambient temperature		-40 ... 60 °C (-40 ... 140 °F)
Storage temperature		-40 ... 70 °C (-40 ... 158 °F)
<b>Mechanical specifications</b>		
Degree of protection		IP67
Connection		2 m fixed cable
Material		
Housing		PC (Polycarbonate)
Optical face		PMMA
Cable		PVC
Mass		approx. 56 g

## Connection

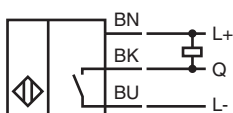

**Indication**

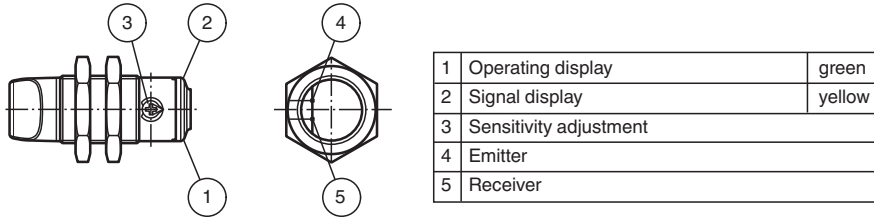



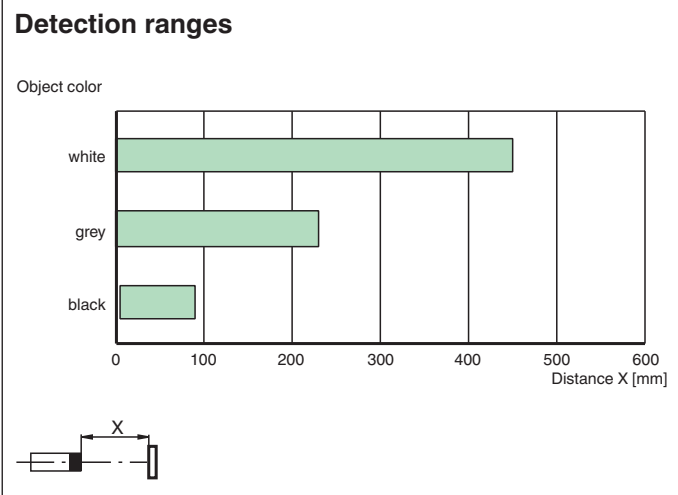
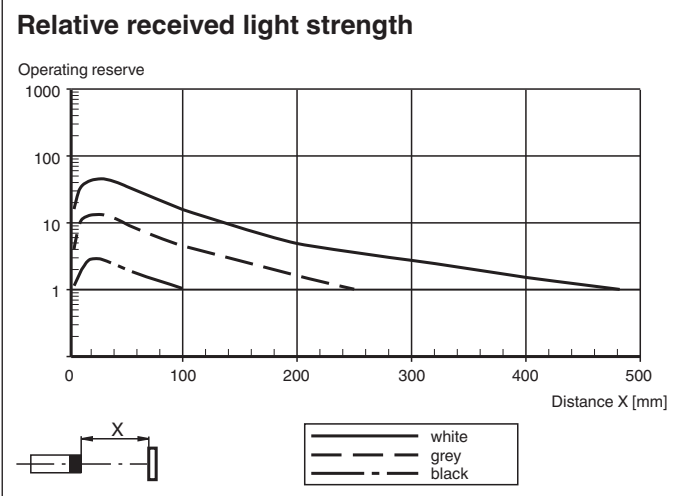
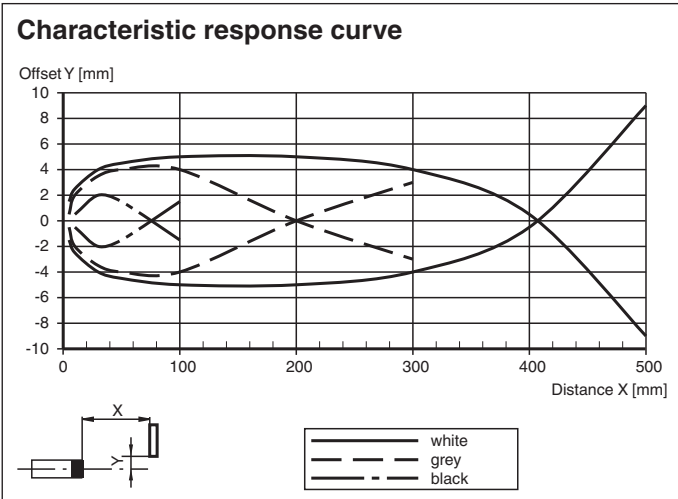

**Characteristic Curve**



Release date: 2022-05-12 Date of issue: 2022-05-12 Filename: 70113328-100090\_eng.pdf

Refer to "General Notes Relating to Pepperl+Fuchs Product Information".

## Accessories

	<b>OMH-04</b>	Mounting aid for round steel $\varnothing$ 12 mm or sheet 1.5 mm ... 3 mm
	<b>BF 18</b>	Mounting flange, 18 mm
	<b>BF 18-F</b>	Plastic mounting adapter, 18 mm
	<b>BF 5-30</b>	Universal mounting bracket for cylindrical sensors with a diameter of 5 ... 30 mm
	<b>CPZ18B03</b>	Mounting Bracket with swivel nut