



RFID read/write device

IQH1-FP7V4A

- Operating frequency 13.56 MHz
- Conforms to ISO 15693
- Suitable for FRAM transponder
- Dual-LED for function display
- Stainless steel housing
- Resistant against cleaning material
- Connection via terminal compartment
- Degree of protection IP67 / IP68 / IP69K
- For connection to IDENTControl control interface

HF RFID read/write device, ISO 15693, for IDENTControl



Dimensions

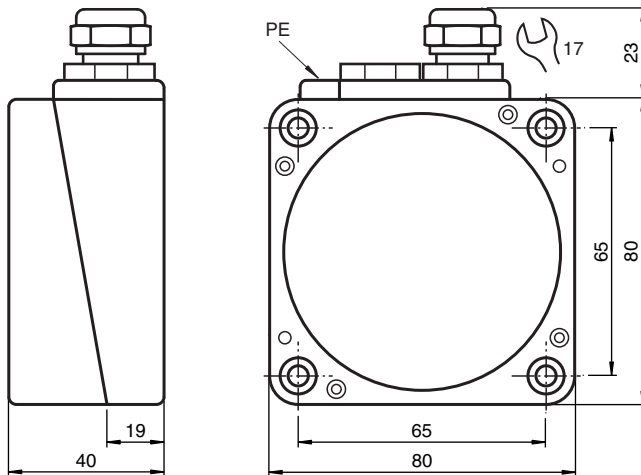

Technical Data

General specifications	
Operating frequency	13.56 MHz
Transfer rate	26 kBit/s
Sensing range	
Read distance	0 ... 130 mm
Write distance	0 ... 130 mm
Width	max. 100 mm
UL File Number	E87056
MTBF	110 a (Operation at +40 °C)
Indicators/operating means	
LED green/yellow	green: power on green flashing: read/write attempt performed yellow: data carrier detected
Electrical specifications	
Power consumption	$P_0 \leq 1.3 \text{ W}$
Supply	from the IDENTControl
Directive conformity	
Radio equipment	

Release date: 2023-08-07 Date of issue: 2023-08-07 Filename: 304916_eng.pdf

Refer to "General Notes Relating to Pepperl+Fuchs Product Information".

Pepperl+Fuchs Group
www.pepperl-fuchs.com

USA: +1 330 486 0001
fa-info@us.pepperl-fuchs.com

Germany: +49 621 776 1111
fa-info@de.pepperl-fuchs.com

Singapore: +65 6779 9091
fa-info@sg.pepperl-fuchs.com

 PEPPERL+FUCHS

Technical Data

Directive 2014/53/EU	EN 301489-1 EN 301489-3 EN 300330 EN 62368-1 EN 50364
RoHS	
Directive 2011/65/EU (RoHS)	IEC/EN 63000
Standard conformity	
Degree of protection	EN 60529
RFID	ISO/IEC 15693-2 ISO/IEC 15693-3 ISO/IEC 18000-3
Ambient conditions	
Ambient temperature	-25 ... 70 °C (-13 ... 158 °F)
Storage temperature	-40 ... 85 °C (-40 ... 185 °F)
Mechanical specifications	
Housing length	108.5 mm
Housing width	80 mm
Housing height	40 mm
Degree of protection	IP69K
Connection	terminal compartment, ≤ 2.5 mm ² conductor csa
Material	
Housing	PBT
Base	stainless steel V4A
Encapsulation compound	CY 221/HY 2966
Installation	
Distance between two heads	Multiplex on: ≥ 100 mm Multiplex off: ≥ 150 mm
Mass	approx. 700 g

Connection

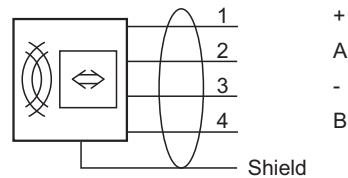











Accessories

	IC-KP-B6-V15B	Control interface unit IDENTControl with PROFIBUS DP interface
	IC-KP-B17-AIDA1	IDENTControl control interface with Ethernet interface for TCP/IP, PROFINET, EtherNet/IP, and MODBUS TCP protocols
	IC-KP2-2HRX-2V1	Control interface unit IDENTControl Compact with serial interface RS-232 and RS-485
	IC-KP2-2HB6-V15B	Control interface unit IDENTControl Compact with interface for PROFIBUS DP
	IC-KP2-2HB17-2V1D	IDENTControl Compact control interface with Ethernet interface for TCP/IP, PROFINET, EtherNet/IP, and MODBUS TCP protocols

Release date: 2023-08-07 Date of issue: 2023-08-07 Filename: 304916_eng.pdf

Refer to "General Notes Relating to Pepperl+Fuchs Product Information".

Accessories

	IC-KP2-2HB21-2V1D	Control interface unit IDENTControl Compact with EtherCAT interface
	IQC21-50F-T10	Data carrier
	IQC21-58	Data carrier
	IQC22-22-T9 50pcs	Data carrier
	IQC33-20 50pcs	Data carrier
	IQC33-50 25pcs	Data carrier
	IQC21-50 25pcs	Data carrier
	IQC33-30 25pcs	Data carrier
	IQC21-30 25pcs	Data carrier
	IQC21-16 50pcs	Data carrier
	IQC21-10	Data carrier

Release date: 2023-08-07 Date of issue: 2023-08-07 Filename: 304916_eng.pdf

Refer to "General Notes Relating to Pepperl+Fuchs Product Information".

Pepperl+Fuchs Group
www.pepperl-fuchs.com

USA: +1 330 486 0001
fa-info@us.pepperl-fuchs.com

Germany: +49 621 776 1111
fa-info@de.pepperl-fuchs.com

Singapore: +65 6779 9091
fa-info@sg.pepperl-fuchs.com