



Triangulation sensor (SbR)

OQT350-R201-2EP-IO-L



- Medium design with versatile mounting options
- Multi Pixel Technology (MPT) - flexibility and adaptability
- Reduction of device variety - several switch points within one sensor
- Reliable detection of all surfaces, independent of color and structure
- Low sensitivity to target color
- IO-Link interface for service and process data

Measuring sensor with multiple switch points



IO-Link

Function

The optical sensors in the series are the first devices to offer an end-to-end solution in a medium-sized standard design – from the thru-beam sensor through to the measuring distance sensor. As a result of this design, the sensors are able to perform practically all standard automation tasks.

The entire series enables sensors to communicate via IO-Link.

The DuraBeam laser sensors are durable and can be used in the same way as a standard sensor.

Multi Pixel Technology (MPT) ensures that the standard sensors are flexible and can be adapted to the application environment.

Dimensions

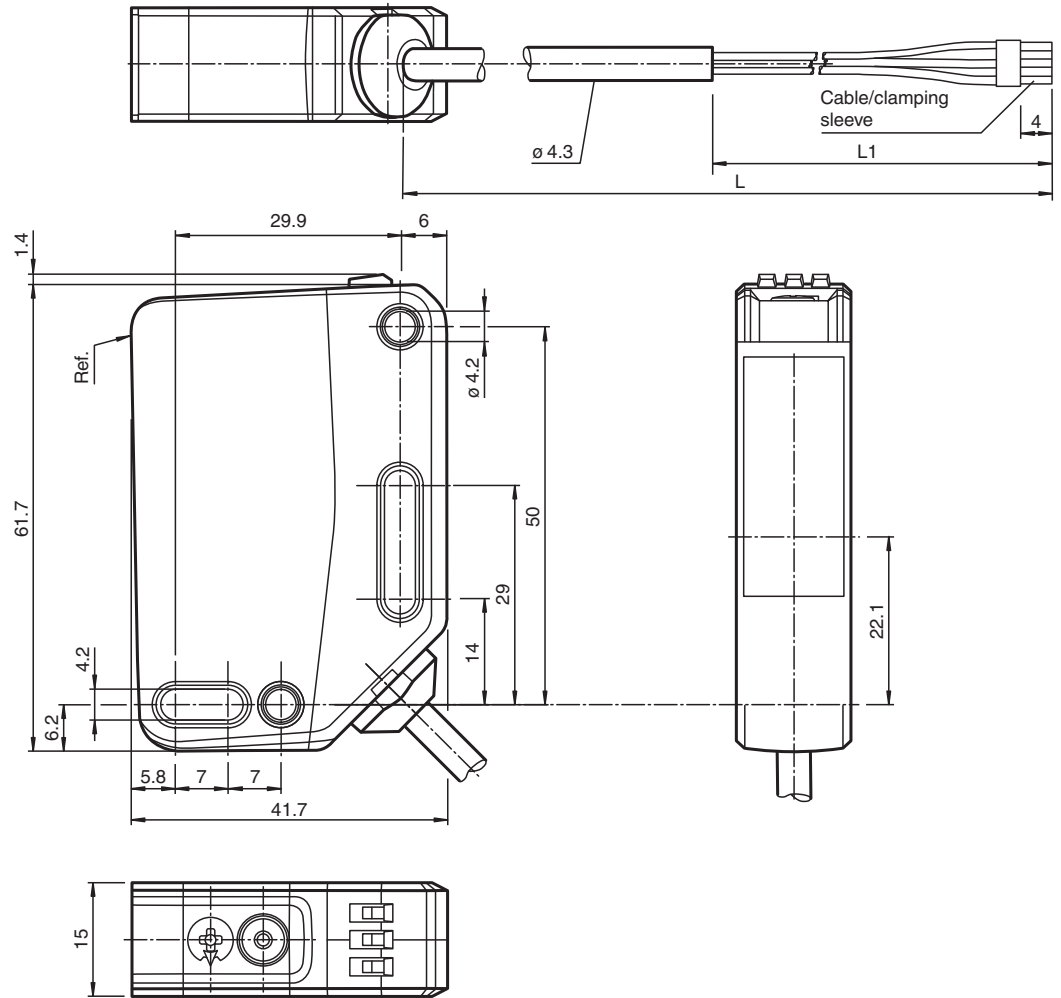

Technical Data

General specifications	
Detection range	60 ... 350 mm
Detection range min.	60 ... 100 mm
Detection range max.	40 ... 400 mm
Adjustment range	100 ... 350 mm
Reference target	standard white, 100 mm x 100 mm
Light source	laser diode
Light type	modulated visible red light
Laser nominal ratings	
Note	LASER LIGHT , DO NOT STARE INTO BEAM
Laser class	1
Wave length	680 nm
Beam divergence	> 5 mrad, d63 < 2,8 mm in the range of 350 mm ... 800 mm
Pulse length	5.5 µs
Repetition rate	approx. 2.4 kHz
max. pulse energy	< 40 nJ
Black-white difference (6 %/90 %)	< 2 %
Diameter of the light spot	approx. 3 mm at a distance of 350 mm
Opening angle	approx. 0.3 °
Ambient light limit	EN 60947-5-2 : 45000 Lux

Release date: 2023-01-16 Date of issue: 2023-01-16 Filename: 295670-100330_eng.pdf

Refer to "General Notes Relating to Pepperl+Fuchs Product Information".

Technical Data

Functional safety related parameters		
MTTF _d		560 a
Mission Time (T _M)		20 a
Diagnostic Coverage (DC)		0 %
Indicators/operating means		
Operation indicator		LED green: constantly on - power on flashing (4Hz) - short circuit flashing with short break (1 Hz) - IO-Link mode
Function indicator		LED yellow: constantly on - switch output active constantly off - switch output inactive
Control elements		Teach-In key
Control elements		5-step rotary switch for operating modes selection
Electrical specifications		
Operating voltage	U _B	10 ... 30 V DC
Ripple		max. 10 %
No-load supply current	I ₀	< 16 mA at 24 V supply voltage
Protection class		III
Interface		
Interface type		IO-Link (via C/Q = BK)
IO-Link revision		1.1
Device profile		Identification and diagnosis Smart Sensor type 0
Device ID		0x111812 (1120274)
Transfer rate		COM2 (38.4 kBit/s)
Min. cycle time		2.3 ms
Process data width		Process data input 2 Bit Process data output 2 Bit
SIO mode support		yes
Compatible master port type		A
Output		
Switching type		The default setting is: C/Q - BK: NPN normally open, PNP normally closed, IO-Link Q2 - WH: NPN normally open, PNP normally closed
Signal output		2 push-pull (4 in 1) outputs, short-circuit protected, reverse polarity protected, overvoltage protected
Switching voltage		max. 30 V DC
Switching current		max. 100 mA , resistive load
Usage category		DC-12 and DC-13
Voltage drop	U _d	≤ 1.5 V DC
Switching frequency	f	217 Hz
Response time		2.3 ms
Conformity		
Communication interface		IEC 61131-9
Product standard		EN 60947-5-2
Laser safety		EN 60825-1:2014
Approvals and certificates		
UL approval		E87056 , cULus Listed , class 2 power supply , type rating 1
CCC approval		CCC approval / marking not required for products rated ≤36 V
FDA approval		IEC 60825-1:2014 Complies with 21 CFR 1040.10 and 1040.11 except for deviations pursuant to Laser Notice No. 50, dated June 24, 2007
Ambient conditions		
Ambient temperature		-40 ... 60 °C (-40 ... 140 °F) , fixed cable -20 ... 60 °C (-4 ... 140 °F) , movable cable not appropriate for conveyor chains
Storage temperature		-40 ... 70 °C (-40 ... 158 °F)
Mechanical specifications		

Release date: 2023-01-16 Date of issue: 2023-01-16 Filename: 295670-100330_eng.pdf

Refer to "General Notes Relating to Pepperl+Fuchs Product Information".

 Pepperl+Fuchs Group
www.pepperl-fuchs.com

 USA: +1 330 486 0001
fa-info@us.pepperl-fuchs.com

 Germany: +49 621 776 1111
fa-info@de.pepperl-fuchs.com

 Singapore: +65 6779 9091
fa-info@sg.pepperl-fuchs.com

 **PEPPERL+FUCHS**

Technical Data

Housing width	15 mm
Housing height	61.7 mm
Housing depth	41.7 mm
Degree of protection	IP67 / IP69 / IP69K
Connection	2 m fixed cable
Material	
Housing	PC (Polycarbonate)
Optical face	PMMA
Mass	approx. 83 g
Cable length	2 m

Connection

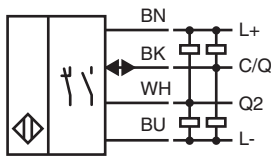

Assembly

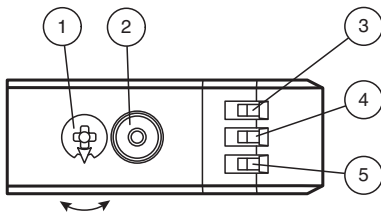

1	Mode rotary switch	
2	Teach-in button	
3	Switching output display Q2	YE
4	Switching output display Q1	YE
5	Operating indicator	GN

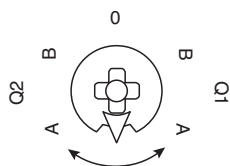

Q1B	Switching output 1/switch point B
Q1A	Switching output 1/switch point A
Q2A	Switching output 2/switch point A
Q2B	Switching output 2/switch point B
0	Keylock

Release date: 2023-01-16 Date of issue: 2023-01-16 Filename: 295670-100330_eng.pdf

Characteristic Curve

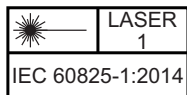
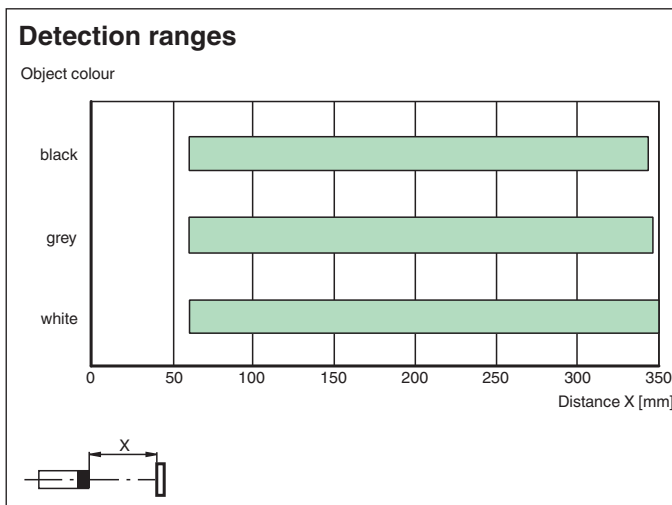
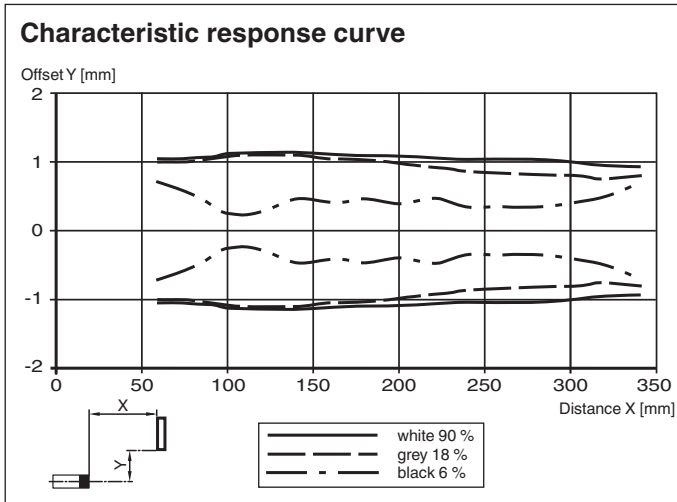









Accessories

	OMH-RL31-02	Mounting bracket narrow
	OMH-RL31-03	Mounting bracket narrow
	OMH-RL31-04	Mounting aid for round steel \varnothing 12 mm or sheet 1.5 mm ... 3 mm
	OMH-RL31-07	Mounting bracket including adjustment
	OMH-R20x-Quick-Mount	Quick mounting accessory
	ICE2-8IOL-G65L-V1D	EtherNet/IP IO-Link master with 8 inputs/outputs

Release date: 2023-01-16 Date of issue: 2023-01-16 Filename: 295670-100330_eng.pdf

Accessories

	ICE3-8IOL-G65L-V1D	PROFINET IO IO-Link master with 8 inputs/outputs
	ICE2-8IOL-K45S-RJ45	EtherNet/IP IO-Link master with 8 inputs/outputs, DIN rail, screw terminal
	ICE3-8IOL-K45P-RJ45	PROFINET IO IO-Link master with 8 inputs/outputs, DIN rail, push-in terminals
	ICE3-8IOL-K45S-RJ45	PROFINET IO IO-Link master with 8 inputs/outputs, DIN rail, screw terminal
	IO-Link-Master02-USB	IO-Link master, supply via USB port or separate power supply, LED indicators, M12 plug for sensor connection
	ICE1-8IOL-G30L-V1D	Ethernet IO-Link module with 8 inputs/outputs
	ICE1-8IOL-G60L-V1D	Ethernet IO-Link module with 8 inputs/outputs
	ICE2-8IOL-K45P-RJ45	EtherNet/IP IO-Link master with 8 inputs/outputs, DIN rail, push-in connectors

Release date: 2023-01-16 Date of issue: 2023-01-16 Filename: 295670-100330_eng.pdf

Refer to "General Notes Relating to Pepperl+Fuchs Product Information".

Pepperl+Fuchs Group
www.pepperl-fuchs.com

USA: +1 330 486 0001
fa-info@us.pepperl-fuchs.com

Germany: +49 621 776 1111
fa-info@de.pepperl-fuchs.com

Singapore: +65 6779 9091
fa-info@sg.pepperl-fuchs.com

Commissioning

Teach-In (TI)

Use the rotary switch for switching signal **Q1** or **Q2** to select the relevant switching threshold A and/or B to teach in.

- The yellow LEDs indicate the current state of the selected output.

To teach in a switching threshold, press and hold the "TI" button for approximately 1 s, until the yellow and green LEDs flash in phase. Teach-in starts when the "TI" button is released.

- Teach-in successful: the yellow and green LEDs flash alternately at 2.5 Hz.
- Teach-in unsuccessful: the yellow and green LEDs quickly flash alternately at 8 Hz.

After an unsuccessful Teach-in, the sensor continues to operate with the previous valid setting after the relevant visual fault signal is issued.

Set switching mode: you can define different switching modes by teaching in the relevant distance data for switching thresholds A and B.

1. Single point mode:

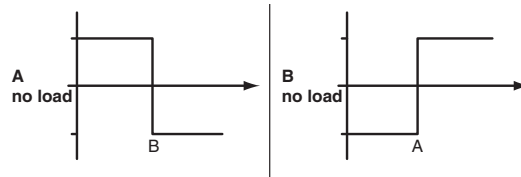

2. Window mode:

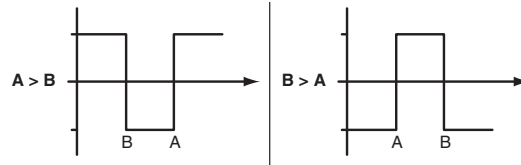

Teach in switching thresholds: you can teach in or overwrite a taught-in switching threshold at any time. To do this, press the "TI" button again.

Reset a value: you can reset a taught-in value. To do this, press the "TI" button for > 4 s, until the yellow and green LEDs go out. The reset process itself starts when the "TI" button is released.

- Reset successful: the yellow and green LEDs flash alternately at 2.5 Hz.

Resetting to Factory Settings

To revert back to factory settings, press the "TI" button for > 10 s with the rotary switch set to position "O," until the yellow and green LEDs go out at the same time. The reset process itself starts when the "TI" button is released.

- Reset to factory settings successful: the yellow and green LEDs light up at the same time. The sensor then continues to operate with factory settings.

OQT

- Factory setting for switching signal Q1:
Switching signal high active, BGS mode (background suppression)
- Factory setting for switching signal Q2:
Switching signal high active, BGS mode (background suppression)

Release date: 2023-01-16 Date of issue: 2023-01-16 Filename: 295670-100330_eng.pdf

Configuration

Configuring different operating modes via the IO-Link interface

The devices are equipped with an IO-Link interface as standard for diagnostics and parameterization tasks to ensure optimum adjustment of the sensors to the relevant application. Four different operating modes can be set, among other features:

Background suppression operating mode (one switch point):

- Detection of objects irrespective of type and color in a defined detection range. Objects in the background are suppressed.



Background evaluation operating mode (one switch point):

Refer to "General Notes Relating to Pepperl+Fuchs Product Information".

- Detection of objects irrespective of type and color against a defined background. Reliable detection of objects at close range (detection range ≥ 0 mm). The background serves as reference.

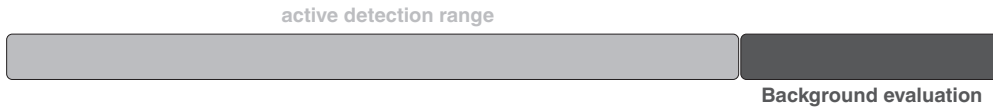

Single point mode operating mode (one switch point):

- Detection of objects irrespective of type and color in a defined detection range. Objects in the background are suppressed.
- The switch point corresponds exactly to the set point.



Window mode operating mode (two switch points):

- Detection of objects irrespective of type and color in a defined detection range. Reliable detection when object leaves the detection range.
- Window mode with two switch points.



Center window mode operating mode (one switch point):

- Detection of objects irrespective of type and color in a defined detection range. Sets a defined window around a given object. Objects outside this window are not detected.
- Window mode with one switch point.



Two point mode operating mode (hysteresis operating mode):

- Detection of objects irrespective of type and color between a defined switch-on and switch-off point.

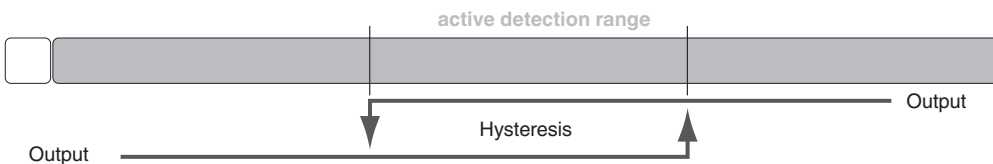

Inactive operating mode:

- Evaluation of switching signals is deactivated.

The associated IODD device description file can be found in the download area at www.pepperl-fuchs.com.

Release date: 2023-01-16 Date of issue: 2023-01-16 Filename: 295670-100330_eng.pdf