

Cable socket, shielded

V1-W-3M-PUR-ABG0

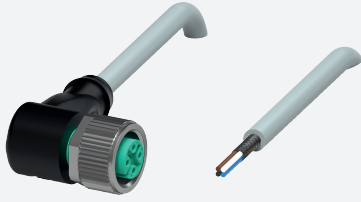

- Degree of protection IP68 / IP69
- Halogen-free
- Shield not connected to screw connection
- Specific design protects against loosening and inaccurate installation

Female cordset single-ended M12 angled A-coded, 4-pin, PUR cable grey, shielded



Dimensions

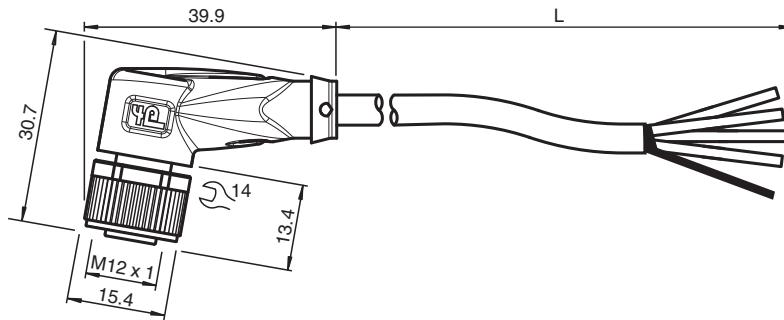

Technical Data

General specifications

Connector 1	
Connection	socket
Construction type	M12
Style	angled
Locking	screw connection
Number of pins	4
Coding	A-coded
Connector 2	
Connection	cable end

Electrical specifications

Operating voltage	U_B	max. 48 V AC / 60 V DC
Operating current	I_B	max. 4 A

Conformity

Degree of protection	EN 60529
Plug connection	connector M12 x 1 : IEC 61076-2-101
Halogen-free	DIN VDE 0472-815 DIN EN 50267-2-1

Ambient conditions

Ambient temperature	
Plug connector	-40 ... 90 °C (-40 ... 194 °F)
Cable, fixed	-40 ... 80 °C (-40 ... 176 °F)

Release date: 2023-08-23 Date of issue: 2023-08-23 Filename: 230735_eng.pdf

Refer to "General Notes Relating to Pepperl+Fuchs Product Information".

Pepperl+Fuchs Group
www.pepperl-fuchs.com

USA: +1 330 486 0001
fa-info@us.pepperl-fuchs.com

Germany: +49 621 776 1111
fa-info@de.pepperl-fuchs.com

Singapore: +65 6779 9091
fa-info@sg.pepperl-fuchs.com

PEPPERL+FUCHS

Technical Data

Cable, flexing	-25 ... 80 °C (-13 ... 176 °F)	
Pollution degree	3	
Mechanical specifications		
Plug connector		
Tightening torque	0.6 Nm	
Loosening protection	available	
Tool installation	straight knurling and hexagon nut SW = 14 mm	
Mating cycles	min. 100	
Shielding	shield not connected to connector	
Degree of protection	IP68 / IP69	
Cable	according to IEC/EN 60228 (DIN VDE 0295) class 5	
Sheath diameter	4.8 mm	
Bending radius	> 10 x cable diameter, moving > 5 x cable diameter, fixed	
Sheath stripping force	max. 100 N / 300 mm	
Sheath color	grey (similar to RAL 7001)	
Number of cores	4	
Core cross section	0.34 mm ²	
Cores color	Core 1: brown Core 2: white Core 3: blue Core 4: black	
Core construction	19 x 0.15 mm Ø	
Shield	tinned copper braiding, 85 % coverage	
Length	L	3 m
Cable code	Li 9Y 11YM 4 x 0.34	
Material		
Halogen-free	yes	
Plug connector		
Screw connection	Zinc diecast, nickel-plated	
Body	TPU, black	
Seal	FKM	
Contact surface	gold plated (Au)	
Flammability	V-2	
Cable		
Sheathing	PUR based on polyether	
Core insulation	PP	
Chemical resistance	good	



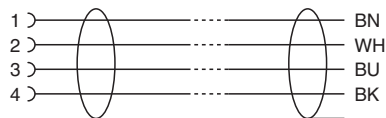
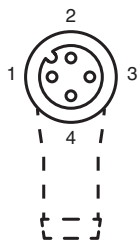



Connection



Accessories

	MH V1-SCREWDRIVER	Torque screwdriver (0.6 Nm)
---	--------------------------	-----------------------------

Accessories

	MH V1-BIT M12	plug-in cap M12
	V1/V3-LABELHOLDER	Label holder
	V1/V3-LABEL	Label plate
	MH V1-Holder	Modular universal holder for M12 connectors
	V1-CLIP	Unlocking protector for M12 connector
	V1-MARKING-RING-COLOR	Marking rings for M12 connectors, various colors