

## WCS3 code rail

WCS3-CS70-M1-S000000-L003000

- Flexible installation by means of alu profile- or mounting bracket system
- High mechanical stability
- Suitable for applications with wide temperature variations

Code rail, stainless steel

### Dimensions

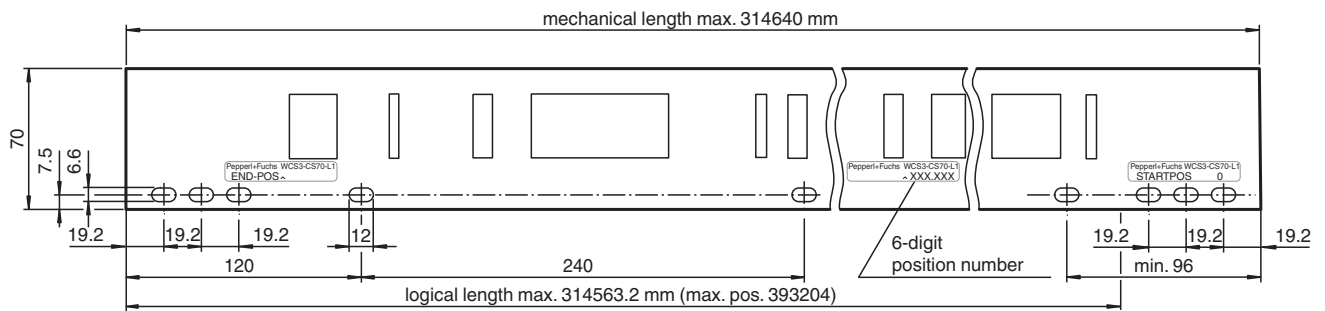

### Technical Data

#### General specifications

Code rail height	70 mm
Total length	3000 mm
Start position	0 mm
Radius of bend	≥ 300 mm

#### Ambient conditions

Operating temperature	-40 ... 100 °C (-40 ... 212 °F)
Storage temperature	-40 ... 100 °C (-40 ... 212 °F)
Installation temperature	10 ... 60 °C (50 ... 140 °F)

#### Mechanical specifications

Material thickness	0.5 mm
Tension loading	≤ 5000 N
Material	stainless steel 1.4310 / AISI 301
Thermal expansion coefficient	1.6 x 10 <sup>-5</sup> / K
Mass	240 g / m
Manufacturing tolerance	± 1 mm/m

Release date: 2023-03-09 Date of issue: 2023-03-09 Filename: 70135878-100011\_eng.pdf

Refer to "General Notes Relating to Pepperl+Fuchs Product Information".

Pepperl+Fuchs Group  
www.pepperl-fuchs.com

USA: +1 330 486 0001  
fa-info@us.pepperl-fuchs.com

Germany: +49 621 776 1111  
fa-info@de.pepperl-fuchs.com

Singapore: +65 6779 9091  
fa-info@sg.pepperl-fuchs.com

**PF** PEPPERL+FUCHS

## Mounting

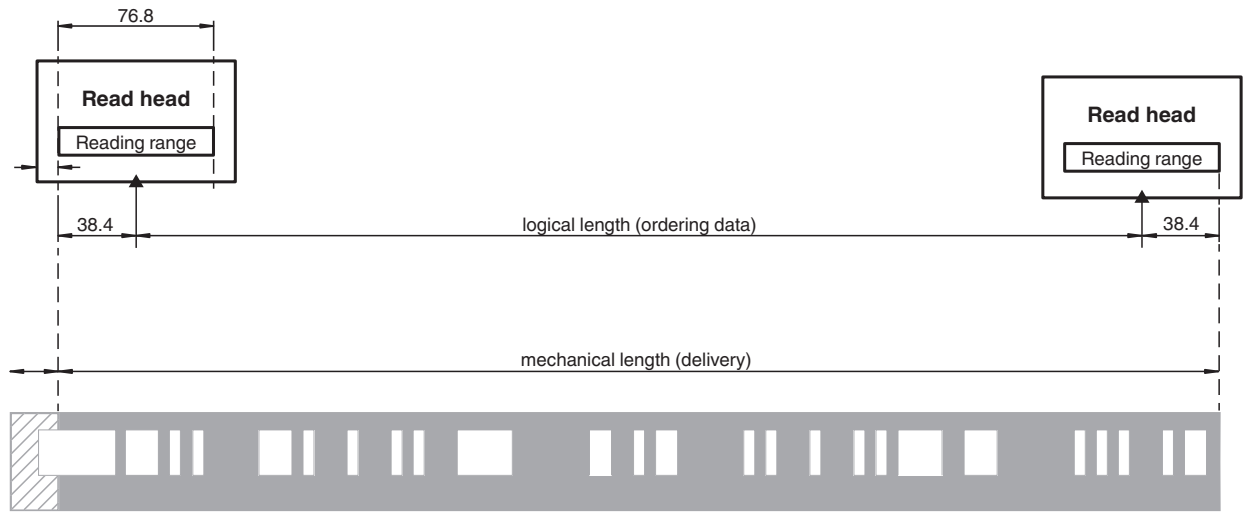

Automatic length correction:  
Code rail is only delivered with  
web ends or web beginnings

## Type Code

### Structure of the type code

W	C	S	3	-	C	S	70	-	M	1	-	S	(1)	(1)	(1)	(1)	(1)	(1)	-	L	(2)	(2)	(2)	(2)	(2)	(2)
---	---	---	---	---	---	---	----	---	---	---	---	---	-----	-----	-----	-----	-----	-----	---	---	-----	-----	-----	-----	-----	-----

<b>WCS3</b>	<b>Read head type</b>
WCS	Position encoding system

<b>CS</b>	<b>Code rail</b>
C	Code
S	Rail

<b>70</b>	<b>Code rail height</b>
70	Code rail height



<b>M</b>	<b>Code rail material</b>
M	Stainless steel

<b>1</b>	<b>Mounting hole type</b>
1	With mounting holes

<b>S (1) (1) (1) (1) (1) (1)</b>	<b>Starting position</b>
0 ... 314463	Starting position of the code rail in mm

















<b>L (2) (2) (2) (2) (2) (2)</b>	<b>Code rail length</b>
100 ... 314563	Length of the code rail in mm

## Accessories

	<b>WCS-MT1</b>	Tensioning device for stainless steel code rail
	<b>WCS-MB2-C</b>	Mounting bracket for C profile, straight section
	<b>WCS-MB1-B</b>	Fastening angle for screw connection, curve

Release date: 2023-03-09 Date of issue: 2023-03-09 Filename: 70135878-100011\_eng.pdf

## Accessories

	<b>WCS-MB2-B</b>	Mounting bracket for C profile, bend
	<b>WCS-SP2</b>	Stabilization profile
	<b>WCS-MB1</b>	Mounting bracket for bolt connection, straight
	<b>WCS3-CS70-E</b>	WCS3 code rail extender
	<b>WCS-MF1</b>	Wrist strap
	<b>WCS3-FT1</b>	Fitting tool for WCS3 aluminum profile system
	<b>WCS3-MC1</b>	Joint
	<b>WCS3-MH1</b>	WCS3 screw-on holder
	<b>WCS3-MH2</b>	WCS3 holder for C profile
	<b>WCS3-PS1-2M</b>	WCS3 profile rail
	<b>WCS-MB2</b>	Mounting bracket for C profile, straight section
	<b>WCS2-PS1-2,5M</b>	WCS2 profile rail
	<b>WCS3-GT09-P1-O</b>	WCS3 guiding trolley for the WCS3B read head with protective enclosure, outdoor use
	<b>WCS2-MH1</b>	Rail bracket with screwed connection
	<b>WCS2-MC1</b>	Butt connector, aluminum
	<b>WCS2-LB1</b>	WCS2 locking bracket
	<b>WCS2-FT1</b>	Mounting tool to safely and quickly install the 55 mm code strip in the aluminum profile

Release date: 2023-03-09 Date of issue: 2023-03-09 Filename: 70135878-100011\_eng.pdf

Refer to "General Notes Relating to Pepperl+Fuchs Product Information".

Pepperl+Fuchs Group  
www.pepperl-fuchs.com

USA: +1 330 486 0001  
fa-info@us.pepperl-fuchs.com

Germany: +49 621 776 1111  
fa-info@de.pepperl-fuchs.com

Singapore: +65 6779 9091  
fa-info@sg.pepperl-fuchs.com

 **PEPPERL+FUCHS**