

Connection cable

V11-W-BK4M-PUR-U-V3-GM



- Suitable for drag chains and abrasion resistant
- Suitable for robotic applications / torsion resistant
- Degree of protection IP68
- Free of paint wetting interfering substances
- Resistant to microbes and hydrolysis
- UV resistant
- UL listed for USA and Canada
- Halogen-free
- Specific design protects against loosening and inaccurate installation

Cordset M12 socket angled to M8 plug straight A-coded, 3-pin, PUR cable black, UL approved, drag chain suitable, torsion resistant



Dimensions

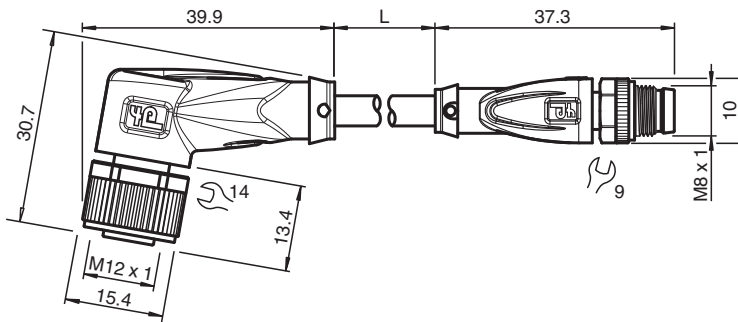

Technical Data

General specifications		
Connector 1		
Connection		socket
Construction type		M12
Style		angled
Locking		screw connection
Number of pins		3
Coding		A-coded
Connector 2		
Connection		plug
Construction type		M8
Style		straight
Locking		screw connection
Number of pins		3
Coding		A-coded
Electrical specifications		
Operating voltage	U_B	max. 48 V AC / 60 V DC
Operating current	I_B	max. 3 A
Conformity		
Degree of protection		EN 60529

Release date: 2023-07-10 Date of issue: 2023-07-10 Filename: 240796-100007_eng.pdf

Refer to "General Notes Relating to Pepperl+Fuchs Product Information".

Pepperl+Fuchs Group
www.pepperl-fuchs.com

USA: +1 330 486 0001
fa-info@us.pepperl-fuchs.com

Germany: +49 621 776 1111
fa-info@de.pepperl-fuchs.com

Singapore: +65 6779 9091
fa-info@sg.pepperl-fuchs.com

PEPPERL+FUCHS

Technical Data

Plug connection		connector M12 x 1 : IEC 61076-2-101 connector M8 x 1 : IEC 61076-2-104
Flammability		UL 1581; DIN EN 60332-2-2
Halogen-free		IEC 60754-1
Approvals and certificates		
UL approval		AWM STYLE 20549 AWM I/II A/B 80°C 300V FT2 (cable)
UL File Number		E231213
Ambient conditions		
Ambient temperature		
Plug connector		-40 ... 90 °C (-40 ... 194 °F)
Cable, fixed		-40 ... 80 °C (-40 ... 176 °F)
Cable, flexing		-20 ... 80 °C (-4 ... 176 °F)
Pollution degree		3
Mechanical specifications		
Connector 1		
Tightening torque		0.6 Nm
Loosening protection		available
Tool installation		straight knurling and hexagon nut SW = 14 mm
Mating cycles		min. 100
Degree of protection		IP68 / IP69
Connector 2		
Tightening torque		0.4 Nm
Loosening protection		available
Tool installation		straight knurling and hexagon nut SW = 9 mm
Mating cycles		min. 100
Degree of protection		IP68
Cable		
according to IEC/EN 60228 (DIN VDE 0295) class 6		
Sheath diameter		4.3 mm
Bending radius		> 10 x cable diameter, moving > 5 x cable diameter, fixed
Sheath stripping force		max. 80 N / 300 mm
Sheath color		black (similar to RAL 9005)
Number of cores		3
Core cross section		0.34 mm ²
Cores color		Core 1: brown Core 3: blue Core 4: black
Core construction		42 x 0.1 mm Ø
Length	L	4 m
Cable code		Li 9Y 11Y 3 x 0.34
Drag chain suitability		
Drag chain cycles		min. 5000000
Motion velocity		max. 3.3 m/s
Traverse distance		max. 5 m
Acceleration		max. 5 m/s ²
Torsion cycles		min. 1000000
Torsional stress		± 180 °/m
Material		
PWIS free		yes
Halogen-free		yes
Plug connector		
Screw connection		Zinc diecast, nickel-plated
Body		TPU, black
Seal		FKM

Release date: 2023-07-10 Date of issue: 2023-07-10 Filename: 240796-100007_eng.pdf

Refer to "General Notes Relating to Pepperl+Fuchs Product Information".

Pepperl+Fuchs Group
www.pepperl-fuchs.com

USA: +1 330 486 0001
fa-info@us.pepperl-fuchs.com

Germany: +49 621 776 1111
fa-info@de.pepperl-fuchs.com

Singapore: +65 6779 9091
fa-info@sg.pepperl-fuchs.com

 PEPPERL+FUCHS







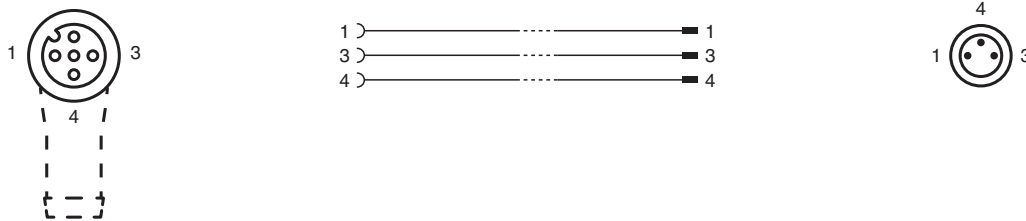



Technical Data

Contact surface	gold plated (Au)
Flammability	V-2
Cable	
Sheathing	PUR based on polyether
Core insulation	PP
UV resistance	yes
Chemical resistance	good
Oil resistance	yes
Cooling lubricant resistance	yes
Microbial resistance	yes
Hydrolysis resistance	yes
Flammability	FT2

Connection



Accessories

	MH V1-SCREWDRIVER	Torque screwdriver (0.6 Nm)
	MH V1-BIT M12	plug-in cap M12
	V1/V3-LABELHOLDER	Label holder
	V1/V3-LABEL	Label plate
	MH V1-Holder	Modular universal holder for M12 connectors
	V1-CLIP	Unlocking protector for M12 connector
	V1-MARKING-RING-COLOR	Marking rings for M12 connectors, various colors
	MH V3-SCREWDRIVER	Torque screwdriver (0.4 Nm)
	MH V3-BIT M8	plug-in cap for M8
	MH V3-Holder	Modular universal holder for M8 connectors

Release date: 2023-07-10 Date of issue: 2023-07-10 Filename: 240796-100007_eng.pdf