

Female cordset

V15-W-VT2M-PUR-U/CAN

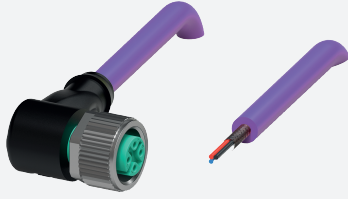

- Suitable for DeviceNet and CANopen
- Suitable for drag chains and abrasion resistant
- Degree of protection IP68 / IP69
- Resistant to microbes and hydrolysis
- Resistant to salt water
- UL listed for USA and Canada
- Halogen-free
- Specific design protects against loosening and inaccurate installation

DeviceNet/CANOpen bus cable female cordset single-ended M12 angled A-coded, 5-pin, PUR cable violet, shielded, UL approved, drag chain suitable, salt water resistant



Dimensions

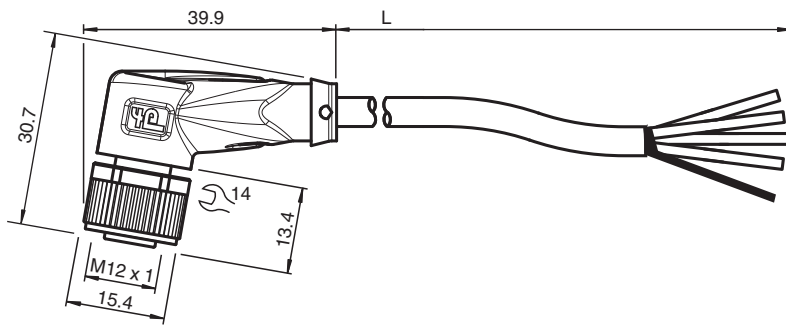

Technical Data

General specifications

| | |
|-------------------|------------------|
| Connector 1 | |
| Connection | socket |
| Construction type | M12 |
| Style | angled |
| Locking | screw connection |
| Number of pins | 5 |
| Coding | A-coded |
| Connector 2 | |
| Connection | cable end |

Electrical specifications

| | | |
|--------------------------|-------|--|
| Operating voltage | U_B | max. 48 V AC / 60 V DC |
| Operating current | I_B | max. 4 A |
| Characteristic impedance | | 120 Ω \pm 12 Ω (1 MHz) |

Conformity

| | |
|----------------------|----------|
| Degree of protection | EN 60529 |
|----------------------|----------|

Release date: 2023-02-10 Date of issue: 2023-02-10 Filename: 70114143_eng.pdf

Refer to "General Notes Relating to Pepperl+Fuchs Product Information".

Pepperl+Fuchs Group
www.pepperl-fuchs.com

USA: +1 330 486 0001
fa-info@us.pepperl-fuchs.com

Germany: +49 621 776 1111
fa-info@de.pepperl-fuchs.com

Singapore: +65 6779 9091
fa-info@sg.pepperl-fuchs.com

PEPPERL+FUCHS

Technical Data

| | | |
|-----------------------------------|---|---|
| Plug connection | | connector M12 x 1 : IEC 61076-2-101 |
| Flammability | | UL 2556 , IEC 60332-1-2 |
| Halogen-free | | IEC 60754-1 |
| Chemical resistance | | DIN EN 60811-2-1 |
| Oil resistance | | DIN EN 60811-2-1 |
| Approvals and certificates | | |
| UL approval | | CMX listed (cable) |
| UL File Number | | E231213 |
| Ambient conditions | | |
| Ambient temperature | | |
| Plug connector | | -25 ... 90 °C (-13 ... 194 °F) |
| Cable, fixed | | -20 ... 80 °C (-4 ... 176 °F) |
| Cable, flexing | | -20 ... 80 °C (-4 ... 176 °F) |
| Pollution degree | | 3 |
| Mechanical specifications | | |
| Plug connector | | |
| Tightening torque | | 0.6 Nm |
| Loosening protection | | available |
| Tool installation | | straight knurling and hexagon nut SW = 14 mm |
| Mating cycles | | min. 100 |
| Shielding | | shield connected to pin 1 and screw connection |
| Degree of protection | | IP68 / IP69 |
| Cable | | |
| Sheath diameter | | 6.1 mm |
| Bending radius | | > 8 x cable diameter, moving > 4 x cable diameter, fixed |
| Sheath stripping force | | max. 60 N / 100 mm |
| Sheath color | | violet (similar to RAL 4001) |
| Number of cores | | 4 |
| Core cross section | | 0.34 mm ² |
| Coors color | | Core 1: red Core 2: black Core 3: white Core 4: blue |
| Core construction | | 7 x 0.254 mm Ø twisted quad |
| Shield | | tinned copper braiding, 80 % coverage |
| Length | L | 2 m |
| Cable code | | Li 9Y 11Y 4 x 0.34 |
| Drag chain suitability | | |
| Drag chain cycles | | min. 3000000 |
| Motion velocity | | max. 2.5 m/s |
| Acceleration | | max. 12 m/s ² |
| Material | | |
| Halogen-free | | yes |
| Plug connector | | |
| Screw connection | | Zinc diecast, nickel-plated |
| Body | | TPU, black |
| Seal | | FKM |
| Contact surface | | gold plated (Au) |
| Flammability | | V-2 |
| Cable | | |
| Sheathing | | PUR based on polyether |
| Core insulation | | PP |
| Salt water resistance | | yes |

Release date: 2023-02-10 Date of issue: 2023-02-10 Filename: 70114143_eng.pdf

Refer to "General Notes Relating to Pepperl+Fuchs Product Information".





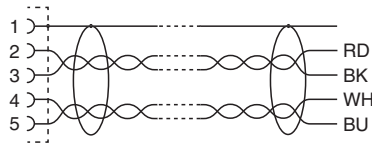
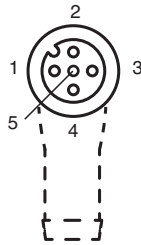

Technical Data

| | |
|-----------------------|------|
| Oil resistance | yes |
| Microbial resistance | yes |
| Hydrolysis resistance | yes |
| Flammability | VW-1 |

Connection Assignment



Accessories

| | | |
|---|------------------------------|--|
|  | MH V1-SCREWDRIVER | Torque screwdriver (0.6 Nm) |
|  | MH V1-BIT M12 | plug-in cap M12 |
|  | V1/V3-LABELHOLDER | Label holder |
|  | V1/V3-LABEL | Label plate |
|  | MH V1-Holder | Modular universal holder for M12 connectors |
|  | V1-CLIP | Unlocking protector for M12 connector |
|  | V1-MARKING-RING-COLOR | Marking rings for M12 connectors, various colors |

Release date: 2023-02-10 Date of issue: 2023-02-10 Filename: 70114143_eng.pdf