

Cable socket, shielded

V1-W-A2-50M-PUR-ABG0



- Built-in LED, as operating and function indicator
- Degree of protection IP68 / IP69
- Halogen-free
- Shield not connected to screw connection
- Specific design protects against loosening and inaccurate installation

Female cordset single-ended M12 straight A-coded, LED 4-pin, PUR cable grey, shielded



Dimensions

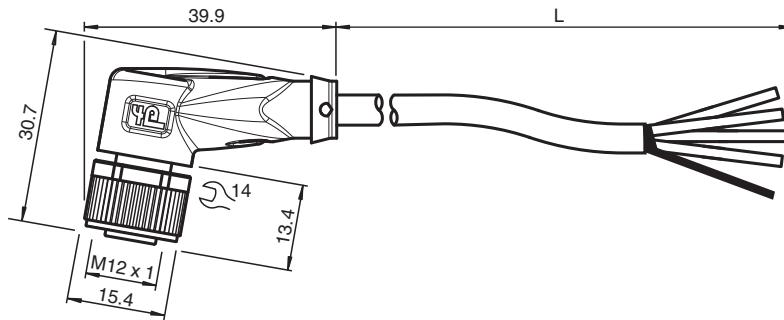

Technical Data

General specifications

Connector 1	
Connection	socket
Construction type	M12
Style	straight
Locking	screw connection
Number of pins	4
Coding	A-coded
Connector 2	
Connection	cable end

Indicators/operating means

LED green	Operating display
LED yellow	Functional display pin 4

Electrical specifications

Operating voltage	U_B	max. 24 V DC -20 % / +25 %
Operating current	I_B	max. 4 A

Conformity

Degree of protection	EN 60529
Plug connection	connector M12 x 1 : IEC 61076-2-101
Halogen-free	DIN VDE 0472-815 DIN EN 50267-2-1

Ambient conditions

Release date: 2023-09-04 Date of issue: 2023-09-04 Filename: 264172_eng.pdf

Refer to "General Notes Relating to Pepperl+Fuchs Product Information".





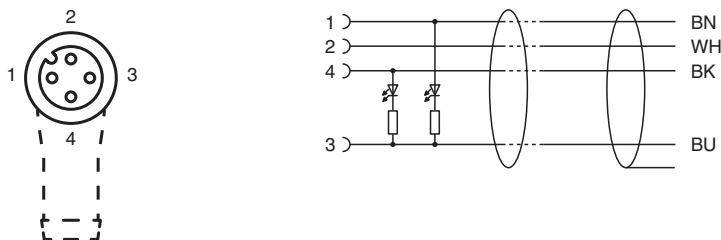

Technical Data

Ambient temperature		
Plug connector		-40 ... 90 °C (-40 ... 194 °F)
Cable, fixed		-40 ... 80 °C (-40 ... 176 °F)
Cable, flexing		-25 ... 80 °C (-13 ... 176 °F)
Pollution degree		3
Mechanical specifications		
Plug connector		
Tightening torque		0.6 Nm
Loosening protection		available
Tool installation		straight knurling and hexagon nut SW = 14 mm
Mating cycles		min. 100
Shielding		shield not connected to connector
Degree of protection		IP68 / IP69
Cable		
Sheath diameter		4.8 mm
Bending radius		> 10 x cable diameter, moving > 5 x cable diameter, fixed
Sheath stripping force		max. 100 N / 300 mm
Sheath color		grey (similar to RAL 7001)
Number of cores		4
Core cross section		0.34 mm ²
Cores color		Core 1: brown Core 2: white Core 3: blue Core 4: black
Core construction		19 x 0.15 mm Ø
Shield		tinned copper braiding, 85 % coverage
Length	L	50 m
Cable code		Li 9Y 11YM 4 x 0.34
Material		
Halogen-free		yes
Plug connector		
Screw connection		Zinc diecast, nickel-plated
Body		TPU, transparent
Seal		FKM
Contact surface		gold plated (Au)
Flammability		V-2
Cable		
Sheathing		PUR based on polyether
Core insulation		PP
Chemical resistance		good

Connection



Accessories

	MH V1-SCREWDRIVER	Torque screwdriver (0.6 Nm)
	MH V1-BIT M12	plug-in cap M12
	V1/V3-LABELHOLDER	Label holder
	V1/V3-LABEL	Label plate
	MH V1-Holder	Modular universal holder for M12 connectors
	V1-CLIP	Unlocking protector for M12 connector
	V1-MARKING-RING-COLOR	Marking rings for M12 connectors, various colors