

Safety control unit module

SB4 Module 2E/165



- OSSD-R/E-stop-module
- Safety outputs OSSD, external status displays OSSD
- 2 sensor channels
- Operating mode can be selected by means of DIP switches
- Start/Restart disable
- Relay monitor
- Stop function Cat.0 or Cat.1 and central stop function Cat.0
- Time function
- Screw terminals or spring terminals

Safety control unit module



Dimensions

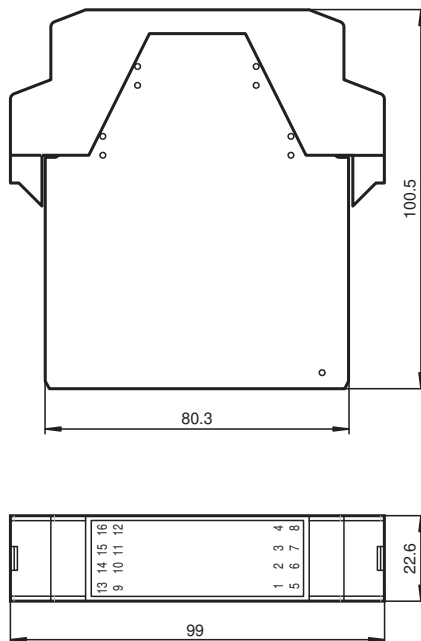

Technical Data

General specifications

Operating mode Startup/restart disable, relay monitor, emergency off, turn off time

Functional safety related parameters

| | |
|--------------------------------|--------|
| Safety Integrity Level (SIL) | SIL 3 |
| Performance level (PL) | PL e |
| Category | Cat. 4 |
| Mission Time (T _M) | 20 a |
| Type | 4 |

Indicators/operating means

Release date: 2023-02-15 Date of issue: 2023-02-15 Filename: 206756_eng.pdf

Refer to "General Notes Relating to Pepperl+Fuchs Product Information".

Pepperl+Fuchs Group
www.pepperl-fuchs.com

USA: +1 330 486 0001
fa-info@us.pepperl-fuchs.com

Germany: +49 621 776 1111
fa-info@de.pepperl-fuchs.com

Singapore: +65 6779 9091
fa-info@sg.pepperl-fuchs.com

PF PEPPERL+FUCHS

Technical Data

| | | |
|-----------------------------------|-------|---|
| Function indicator | | LED red: OSSD OFF LED green: OSSD ON Yellow LED: start readiness LED yellow (2x): indicator lamp channel 1 ... 2 |
| Control elements | | DIP switch |
| Electrical specifications | | |
| Operating voltage | U_B | 24 V DC \pm 20 % , 24 V DC \pm 20 % , via SB4 Housing |
| Input | | |
| Activation current | | approx. 7 mA |
| Test input | | Reset-input for system test |
| Output | | |
| Safety output | | 2 relay outputs, force-guided NO-contact |
| Signal output | | Output for displaying the switching state of the OSSDs |
| Switching voltage | | 10 V ... 250 V AC/DC |
| Switching current | | min. 10 mA , max. 6 A AC/DC |
| Switching power | | max. DC 24 VA , AC 230 VA |
| Conformity | | |
| Functional safety | | ISO 13849-1 ; EN 61508 part1-4 |
| Product standard | | EN 61496-1 |
| Approvals and certificates | | |
| CE conformity | | CE |
| UL approval | | cULus |
| TÜV approval | | TÜV |
| Ambient conditions | | |
| Ambient temperature | | 0 ... 50 °C (32 ... 122 °F) |
| Storage temperature | | -20 ... 70 °C (-4 ... 158 °F) |
| Mechanical specifications | | |
| Degree of protection | | IP20 |
| Connection | | Cage tension spring terminals , Cable cross-section 0.2 ... 1.5 mm ² |
| Material | | |
| Housing | | Polyamide (PA) |
| Mass | | approx. 150 g |



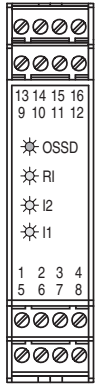

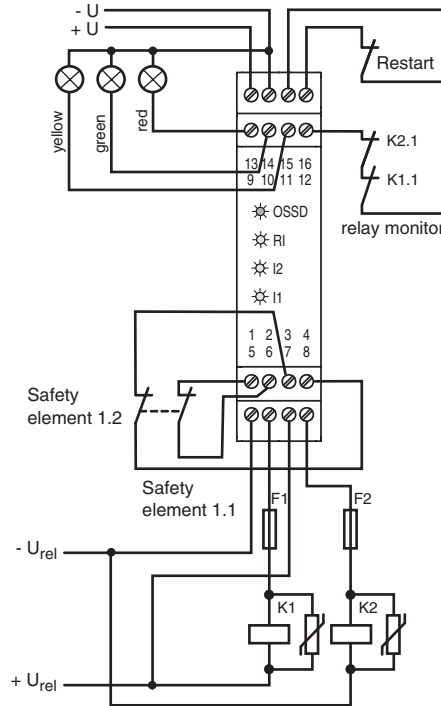

Connection



| Terminal | Function |
|----------|--|
| 1 | Safety element 1.1 Out |
| 2 | Safety element 1.1 In |
| 3 | Safety element 1.2 Out |
| 4 | Safety element 1.2 In |
| 5 - 6 | OSSD1; potential free relay contact; normally open contact |
| 7 - 8 | OSSD2; potential free relay contact; normally open contact |
| 9 | Signal output OSSD off |
| 10 | Signal output OSSD on |
| 11 | Signal output restart |
| 12 | Relay monitor (RM) |
| 13 | +24 V DC supply voltage |
| 14 | 0 V DC supply voltage |
| 15 | 24 V DC connection restart and RM |
| 16 | Restart input (RI); normally closed contact |



Accessories

| | | |
|---|----------------------|---------------------------------------|
|  | SB4 Cape | cover sheet |
|  | SB4 Housing 2 | Empty housing for Evaluation unit SB4 |
|  | SB4 Housing 3 | Empty housing for Evaluation unit SB4 |
|  | SB4 Housing 4 | Empty housing for Evaluation unit SB4 |
|  | SB4 Housing 5 | Empty housing for Evaluation unit SB4 |
|  | SB4 Housing 6 | Empty housing for Evaluation unit SB4 |
|  | SB4 Housing 8 | Empty housing for Evaluation unit SB4 |

Release date: 2023-02-15 Date of issue: 2023-02-15 Filename: 206756_eng.pdf

This module can only be operated within an evaluation device of the SafeBox SB4 type.
The SafeBox instruction manual should be observed.

Function

The OSSD-R/E stop module contains 2 OSSDs, the relay monitor, the restart connection and 2 connections for contact safety signals, (e.g. emergency off button). From position 3 on, this module may exist several times in the SafeBox and may perform different functions depending on the switch position.

The OSSDs are designed as potential free connection NO contacts. The module can be operated with or without restart interlock. Also, monitoring of the externally connected switching elements can be activated (relay monitor). The OSSD On or Off statuses are indicated via a short-circuit-proof pnp signal output. The restart output is used for indication of the start readiness status. In the case of an error, this output oscillates with 1 Hz.

If the inputs remain unused of the OSSD-R/E stop module, a bridge is to be created, this also applies to the set Stop 1 function. The module can work in stop function cat. 0 or cat. 1 or it work in central emergency-stop function cat. 0.

Settings

The assembly contains 16 DIP switches for selecting the functions restart, relay monitor, central emergency-stop, OSSD assignment and time function. For selecting functions, 2 selector switches must always be actuated.

Position of the DIP switches

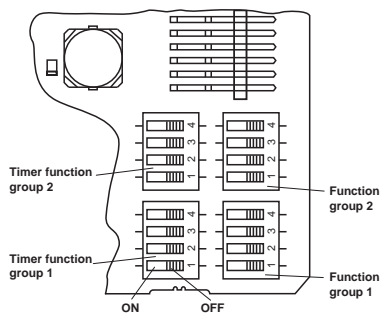

| Switch | Position | Operation type |
|--------------------|----------|--|
| 1 Group 1 and 2 | OFF | Emergency-Stop 0 or 1, effective locally |
| | ON | Function as central Emergency-Stop |
| 2 Group 1 and 2 | OFF | Without restart interlock (restart, RI) |
| | ON | With restart interlock (restart, RI) for stop cat. 0 |
| 3 Group 1 and 2 | OFF | Without relay monitor (RM) |
| | ON | With relay monitor (RM) |
| 4 Group 1 and 2 | OFF | Stop function cat. 0 |
| | ON | Stop function cat. 1 |

| Time value / s | Switch 1 Group 1 and 2 | Switch 2 Group 1 and 2 | Switch 3 Group 1 and 2 | Switch 4 Group 1 and 2 |
|----------------|---------------------------|---------------------------|---------------------------|---------------------------|
| 0.0 | OFF | OFF | OFF | OFF |
| 0.3 | ON | OFF | OFF | OFF |
| 0.4 | OFF | ON | OFF | OFF |
| 0.5 | ON | ON | OFF | OFF |
| 0.63 | OFF | OFF | ON | OFF |
| 0.8 | ON | OFF | ON | OFF |
| 1.0 | OFF | ON | ON | OFF |
| 1.3 | ON | ON | ON | OFF |
| 1.6 | OFF | OFF | OFF | ON |
| 2.0 | ON | OFF | OFF | ON |
| 2.5 | OFF | ON | OFF | ON |
| 3.2 | ON | ON | OFF | ON |
| 4.0 | OFF | OFF | ON | ON |
| 5.0 | ON | OFF | ON | ON |
| 6.3 | OFF | ON | ON | ON |
| 8.0 | ON | ON | ON | ON |

Displays

The OSSD assembly has a red/green LED for indicating the OSSD on/off statuses, a yellow LED for the start-ready status and 2 LEDs for the sensor channels.

Release date: 2023-02-15 Date of issue: 2023-02-15 Filename: 206756_eng.pdf

If there is an error on the OSSD assembly itself, only the displays on this assembly are flashing.

| Display | LED | Meaning |
|---------|--------|---|
| OSSD | red | OSSD outputs switched off |
| | green | OSSD outputs switched on |
| RI | yellow | Continuous light: protected area free, OSSD off, start readiness, actuate restart push button |
| | | Flashing (5 Hz): error on the card, in the switch group or system error |
| I1, I2 | yellow | Continuous light: sensor channel closed |
| | | Flashing (5 Hz): sensor channel error |

Release date: 2023-02-15 Date of issue: 2023-02-15 Filename: 206756_eng.pdf