

Thru-beam sensor

GA18/GK18/59/115/161



- Efficient Line in a short M18 plastic housing for standard applications
- Very high detection range
- 4 LEDs indicator for 360° visibility
- Version with front optical face
- Universal usage at different power supplies

Thru-beam sensor, M18 threaded housing design, plastic housing, front optical face, 20 m detection range, red light, dark on, AC/DC version, NPN-FET output, fixed cable



Function

The GLV/GLK18 series sensors help improve the efficiency of machines and systems. The design of the M18 plastic housing, the connection technology, and sensor properties are highly standardized. Concentrating on the key sensor requirements has produced a robust and reliable product series for DC and AC/DC voltage systems without any over-engineering. The mounting set included in the scope of delivery and the optimized potentiometer design ensure fast assembly and easy configuration.

Application

Packaging industry:

- Presence checks, track loading, completeness checks, stack height control

Material handling:

- Presence checks, target sensor, profile checks, trigger sensor

Automatic doors, gates and access systems, elevator:

- Secure detection for automatic door and gate systems
- Monitoring function in turnstiles
- Closing edge monitoring in elevators

Dimensions

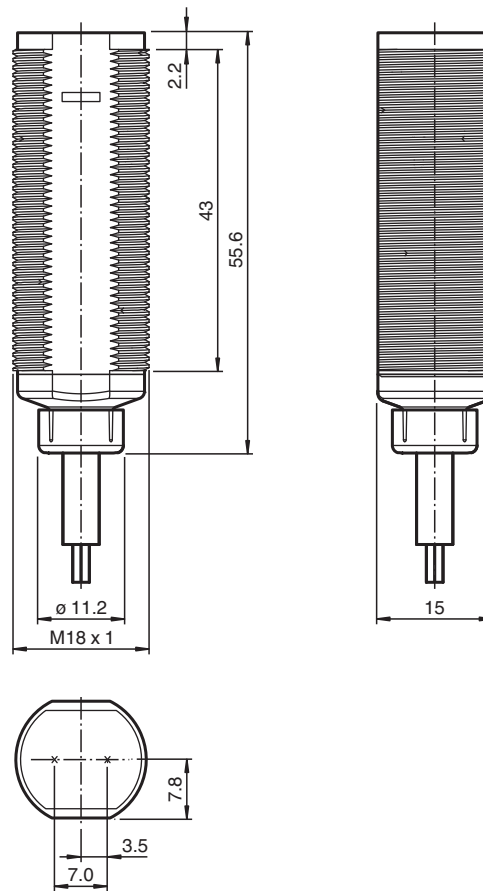

Technical Data

System components	
Emitter	GA18/115
Receiver	GK18/59/115/161
General specifications	
Effective detection range	0 ... 20 m
Threshold detection range	25 m
Light source	LED
Light type	modulated visible red light , 640 nm
Diameter of the light spot	approx. 1000 mm at 25 m
Opening angle	approx. 3 °
Optical face	frontal
Ambient light limit	30000 Lux
Accessories provided	Mounting aids
Indicators/operating means	
Operation indicator	LED green, statically lit Power on
Function indicator	Receiver: LED yellow, lights up when light beam is free, flashes when falling short of the operating reserve ; OFF when light beam is interrupted
Electrical specifications	
Operating voltage	U_B 20 ... 250 V AC/DC
No-load supply current	I_0 < 2.5 mA per device
Output	
Switching type	dark-on

Release date: 2022-11-18 Date of issue: 2022-11-18 Filename: 199777_eng.pdf

Refer to "General Notes Relating to Pepperl+Fuchs Product Information".

Technical Data

Signal output	N-channel MOSFET, short circuit protected	
Switching voltage		max. 250 V AC/DC
Switching current		max. 200 mA
Voltage drop	U_d	≤ 3.5 V AC/DC
Switching frequency	f	50 Hz
Response time		≤ 10 ms
Conformity		
Product standard		EN 60947-5-2
Compliance with standards and directives		
Standard conformity		
Standards		UL 508
Approvals and certificates		
Protection class		II, rated insulation voltage ≤ 250 V AC with pollution degree 1-2 according to IEC 60664-1
UL approval		cULus Listed, Type 1 enclosure For overcurrent protection, install a fuse with a rated current of max. 3 A 250 V AC/DC
CCC approval		Certified by China Compulsory Certification (CCC)
Ambient conditions		
Ambient temperature		-20 ... 60 °C (-4 ... 140 °F)
Storage temperature		-40 ... 70 °C (-40 ... 158 °F)
Mechanical specifications		
Degree of protection		IP67
Connection		2 m fixed cable
Material		
Housing		ABS / PBT
Optical face		PMMA
Mass		approx. 80 g per device

Connection Assignment

Emitter

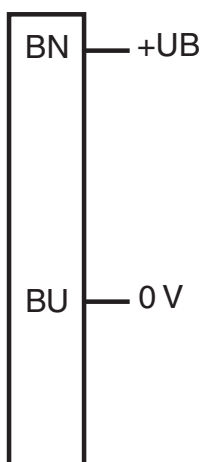

Receiver

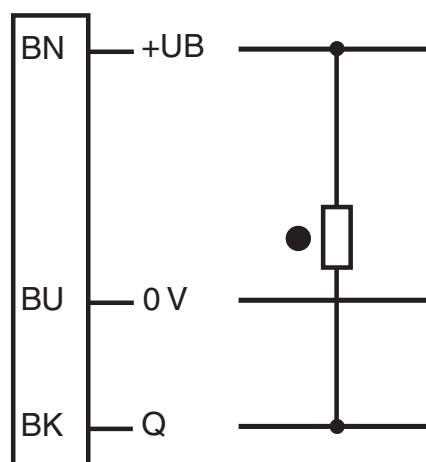

- = Light on
- = Dark on

Release date: 2022-11-18 Date of issue: 2022-11-18 Filename: 199777_eng.pdf

Assembly

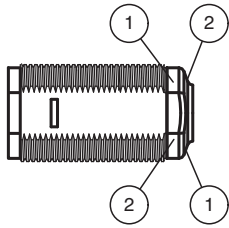

1	Operating display	green
2	Signal display	yellow
4	Emitter	
5	Receiver	

Characteristic Curve

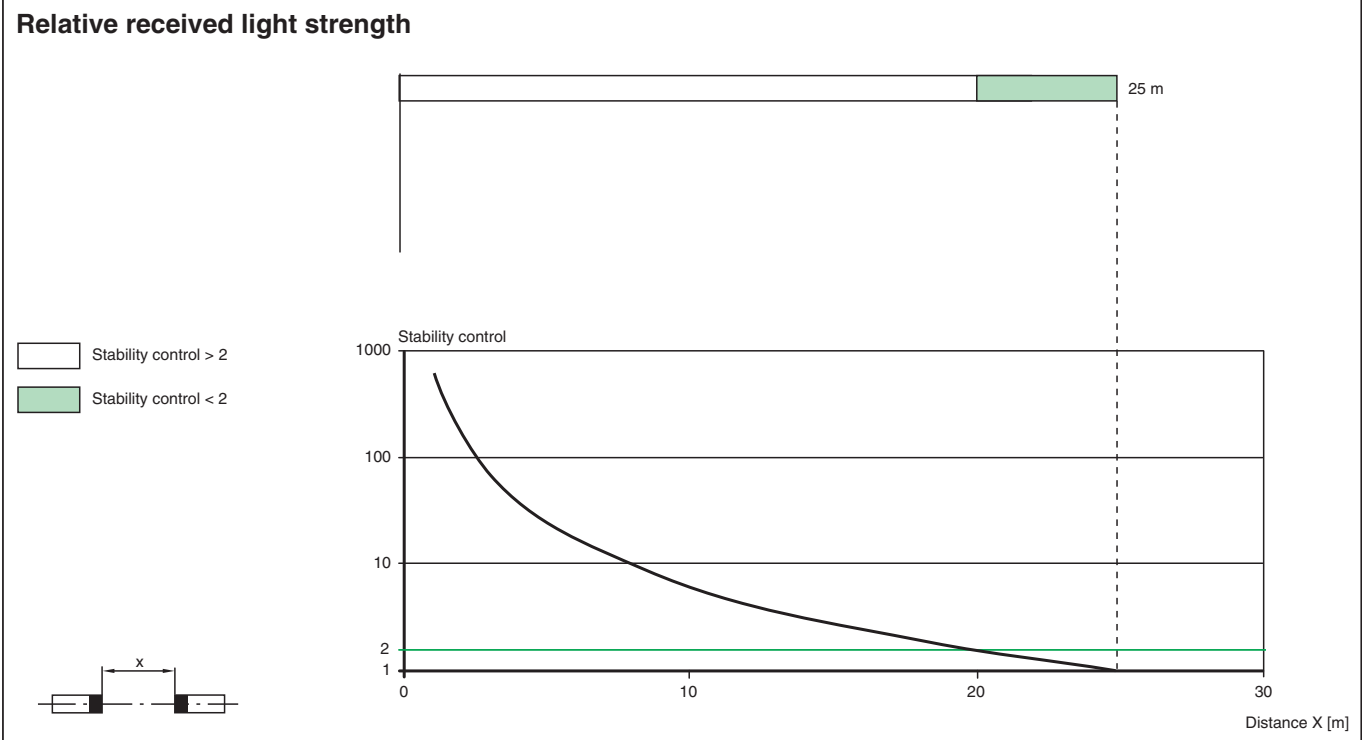
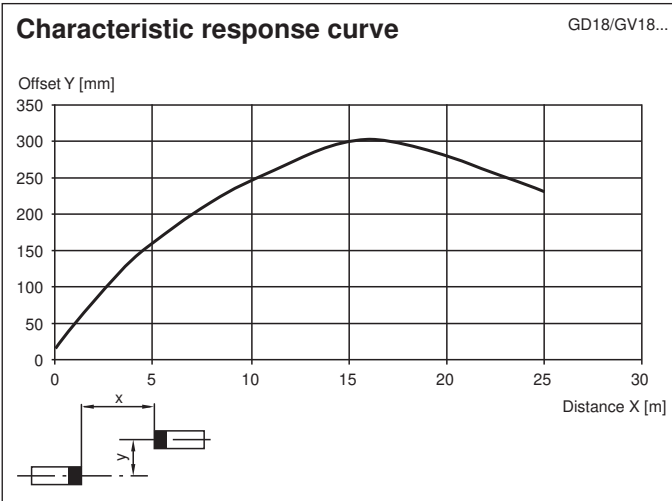

Accessories

	CPZ18B03	Mounting Bracket with swivel nut
	BF 18	Mounting flange, 18 mm

Release date: 2022-11-18 Date of issue: 2022-11-18 Filename: 199777_eng.pdf

Refer to "General Notes Relating to Pepperl+Fuchs Product Information".



Pepperl+Fuchs Group
www.pepperl-fuchs.com

USA: +1 330 486 0001
fa-info@us.pepperl-fuchs.com

Germany: +49 621 776 1111
fa-info@de.pepperl-fuchs.com

Singapore: +65 6779 9091
fa-info@sg.pepperl-fuchs.com

Accessories

	BF 18-F	Plastic mounting adapter, 18 mm
	BF 5-30	Universal mounting bracket for cylindrical sensors with a diameter of 5 ... 30 mm