



Fiber optic sensor SU19/110/115/126a



- Classic line with display
- AGC (Automatic Gain Control) for faster teach-in
- Gang mounting for easy wiring
- Transparency recognition
- 30 μ s High Speed Mode
- Master module

Classic Series fiber optic sensor with display, master module, push-pull output, fixed cable



Function

The fiber optics amplifier SU19 with display was developed to set a benchmark with the most comfortable and user-friendly interface. This simplicity of the settings decreases the costs of ownership significantly. The whole Teach-In process of objects is time-saving due to an easy Teach-In algorithm. The high resolution 4-digit percentage display indicates current values and thresholds with highest accuracy. Wire-saving and the replacement of devices is designed user-friendly and time-saving due to gang mounting on the rear.

Dimensions

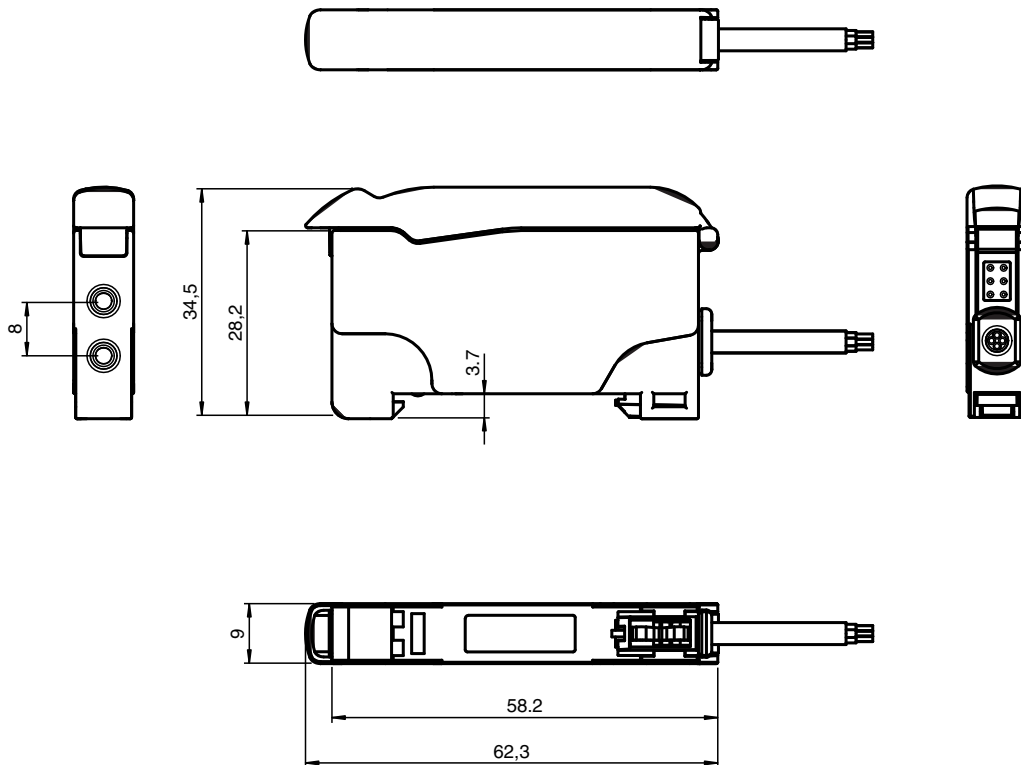

Release date: 2023-04-04 Date of issue: 2023-04-04 Filename: 805075_eng.pdf

Refer to "General Notes Relating to Pepperl+Fuchs Product Information".

Pepperl+Fuchs Group
www.pepperl-fuchs.com

USA: +1 330 486 0001
fa-info@us.pepperl-fuchs.com

Germany: +49 621 776 1111
fa-info@de.pepperl-fuchs.com

Singapore: +65 6779 9091
fa-info@sg.pepperl-fuchs.com

PF PEPPERL+FUCHS

Technical Data

General specifications		
Sensor range		up to 150 mm (KLR-C02-2,2-2,0-K146)
Detection range		up to 450 mm (KLE-C01-2,2-2,0-K116)
Light source		LED
Light type		modulated visible red light , 660 nm
Ambient light limit		10000 Lux
Gang mounting		maximum 20 units
Functional safety related parameters		
MTTF _d		500 a
Mission Time (T _M)		20 a
Diagnostic Coverage (DC)		0 %
Indicators/operating means		
Operation indicator		Power on: static illumination , Undervoltage indicator: Green LED, pulsing (approx. 0.8 Hz) , short-circuit : LED green flashing (approx. 4 Hz)
Diagnostics indicator		7-segment display
Function indicator		LED yellow: static illumination switching state, flashes when falling short of the operating reserve
Control elements		Button (Mode) for menu choice ; Button (Set) for Teach-In ; Button (Up/Down) for fine adjusting and parameterization
Electrical specifications		
Operating voltage	U _B	10 ... 30 V DC
Ripple		10 %
No-load supply current	I ₀	≤ 30 mA
Output		
Stability alarm output		1 push-pull (4 in 1) output NPN/PNP , short-circuit protected
Switching type		light/dark on selectable programmable
Signal output		1 push-pull (4 in 1) output NPN/PNP , short-circuit protected
Switching voltage		max. 30 V DC
Switching current		max. 100 mA , resistive load
Voltage drop	U _d	≤ 2 V DC at 100 mA ; ≤ 0.7 V at 10 mA
Switching frequency	f	High speed mode: 16 kHz , Standard mode: 3 kHz , High resolution: 250 Hz ~ 3 kHz (selection by the sensor), Automatic: 250 Hz , Glass mode: 250 Hz
Response time		High speed mode: 30 μs , Standard mode: 160 μs , High resolution: 2 ms , Automatic: 160 μs ~ 2 ms (choice by the sensor), Glass mode: 2 ms
Repeat accuracy	R	≤ 0.5 % of adjusted sensor range
Timer function		ON-delay, OFF-delay, one shot, pulse extension ; adjustable 0 ... 999 ms in 1 ms increments
Conformity		
Product standard		EN 60947-5-2
Approvals and certificates		
UL approval		cULus Listed, Class 2 Power Source, Type 1 enclosure
CCC approval		CCC approval / marking not required for products rated ≤36 V
Ambient conditions		
Ambient temperature		-10 ... 55 °C (14 ... 131 °F)
Storage temperature		-20 ... 70 °C (-4 ... 158 °F)
Mechanical specifications		
Housing width		9 mm
Housing height		34.5 mm
Housing depth		62.3 mm
Degree of protection		IP50
Connection		2 m PVC cable, 4 x 0,14 mm ²
Material		
Housing		PC
Mass		45 g

Release date: 2023-04-04 Date of issue: 2023-04-04 Filename: 805075_eng.pdf

Connection Assignment

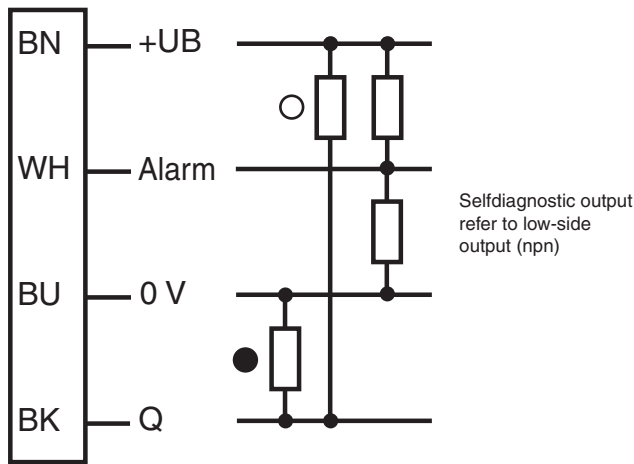

- = Light on
- = Dark on

Assembly

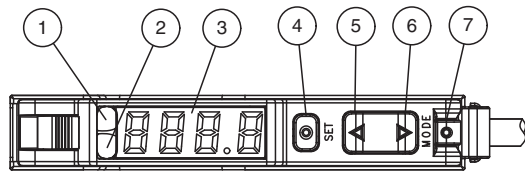

1	Operating display	green
2	Signal display	yellow
3	Display	
4	Button: Set	
5	Button: Up	
6	Button: Down	
7	Button: Mode	

Characteristic Curve

Self-Diagnostic definition and operation:

5 sec. rule for light-ON (LO) and dark-ON (DO) mode

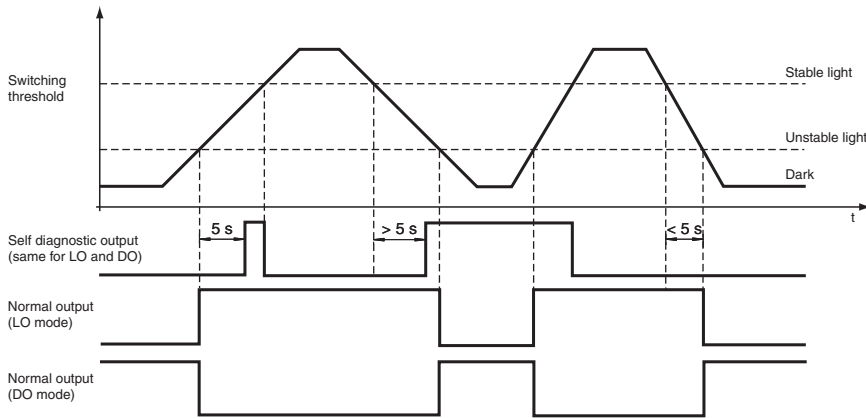

8 cyc. rule for light-ON (LO) and dark-ON (DO) mode

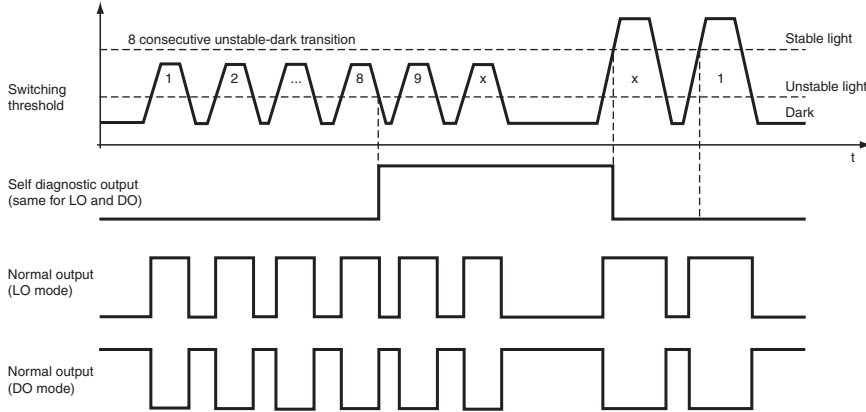

LED indicators and operating chart:

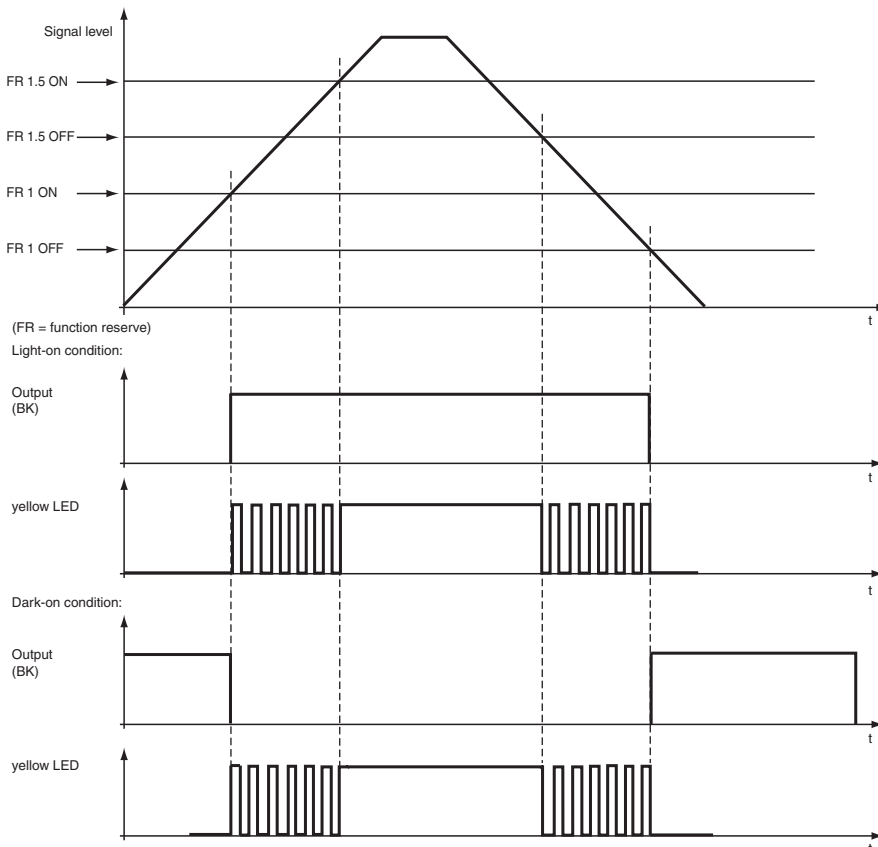

Release date: 2023-04-04 Date of issue: 2023-04-04 Filename: 805075_eng.pdf

Refer to "General Notes Relating to Pepperl+Fuchs Product Information".



















Pepperl+Fuchs Group
www.pepperl-fuchs.com

USA: +1 330 486 0001
fa-info@us.pepperl-fuchs.com

Germany: +49 621 776 1111
fa-info@de.pepperl-fuchs.com

Singapore: +65 6779 9091
fa-info@sg.pepperl-fuchs.com

Accessories

	HPF-D032	Plastic fiber optic
	KLR-C02-2,2-2,0-K146	Plastic fiber optic - diffuse
	KLR-C02-2,2-2,0-K70	Plastic fiber optic - diffuse
	KLR-C02-1,0-2,0-K75	Plastic fiber optic - diffuse
	KLR-C09-1,25-2,0-K76	Plastic fiber optic - diffuse
	KLR-C09-1,25-2,0-K74	Plastic fiber optic - diffuse
	KLR-C16-2,2-2,0-K71	Plastic fiber optic - diffuse
	KLR-A32-2,2-2,0-K83	Plastic fiber optic - diffuse
	KHR-C02-2,2-2,0-K131	Plastic fiber optic - diffuse
	KHTR-C02-2,2-2,0-K88	Plastic fiber optic - diffuse
	KLE-C01-2,2-2,0-K116	Plastic fiber optic - thru-beam
	KLE-C01-2,2-2,0-K103	Plastic fiber optic - thru-beam
	KLE-C01-2,2-2,0-K102	Plastic fiber optic - thru-beam
	KLE-C01-2,2-2,0-K101	Plastic fiber optic - thru-beam
	KLE-C01-2,2-2,0-K113	Plastic fiber optic - thru-beam
	KLE-C01-1,0-2,0-K120	Plastic fiber optic - thru-beam
	KHE-C01-2,2-2,0-K122	Plastic fiber optic - thru-beam
	KHTE-C01-2,2-2,0-K118	Plastic fiber optic - thru-beam
	LHE 00-1,1-1,0-20M4	Glass fiber optic - thru-beam with silicon covering

Release date: 2023-04-04 Date of issue: 2023-04-04 Filename: 805075_eng.pdf

Teach-In methods

Maximum Teach-In

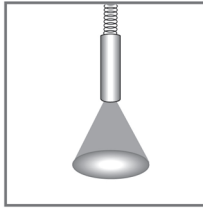
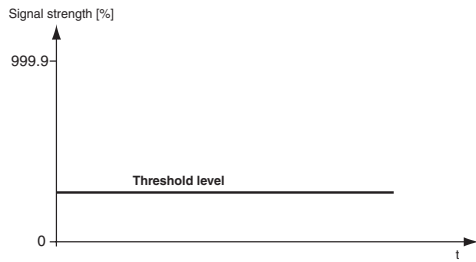

- Gain is set to maximum.
- Threshold is set to minimum.
- Maximum sensitivity is achieved.

Position Teach-In

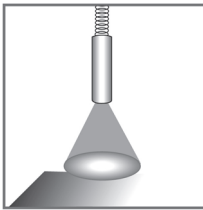
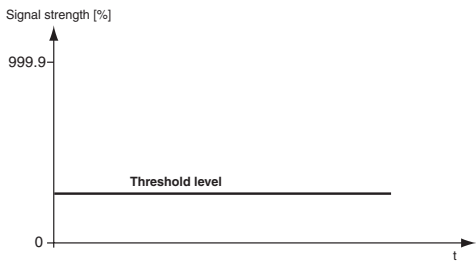

- Sensor set the optimum gain.
- Threshold is set to minimum.
- Signal received is ~ 100 %.

2-Point Teach-In

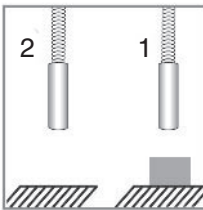
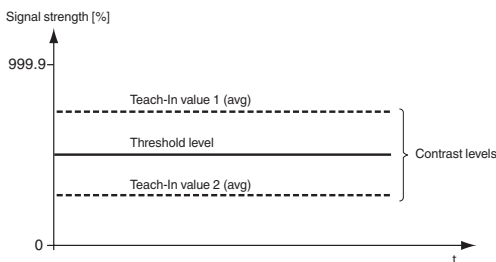

- Sensor set the optimum gain.
- Threshold is set in the middle of the 2 average taught values.

Dynamic Teach-In

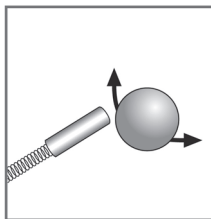
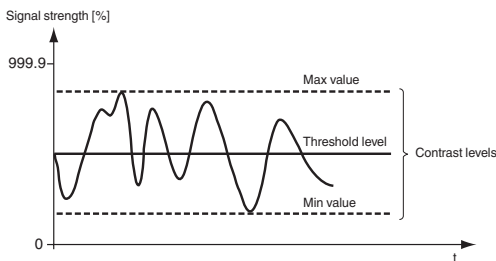

- Sensor set the optimum gain.
- Threshold is placed in the middle of the minimum and maximum taught values.

Glass detection Teach-In

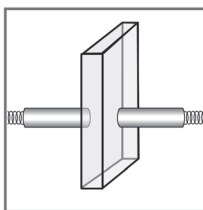
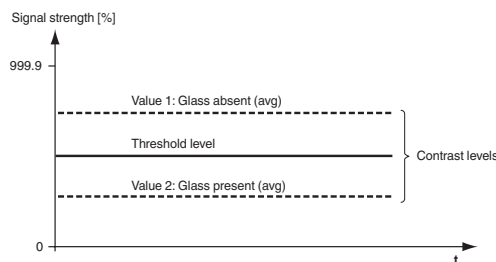

- Sensor set the optimum gain.
- Threshold is set in the middle of the 2 average taught values.

Release date: 2023-04-04 Date of issue: 2023-04-04 Filename: 805075_eng.pdf

Assembly

Selection of the maximum number of connectible slave modules to a master module for cross-talk suppression via bridge contacts.

Number of linkable units	Operating modes			
	Standard	High Resolution	Auto	Glass detection
6u	6 modules	6 modules	6 modules	6 modules
12u	12 modules	12 modules	12 modules	12 modules
18u	18 modules	18 modules	18 modules	18 modules

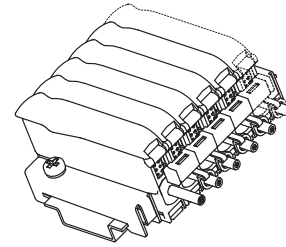

If 12u is selected, the switch-on delay doubles.

If 18u is selected, the switch-on delay triples.

When connecting several modules using bridge contacts, please ensure that the black blind pins on the bridge contacts are cut off. The outer blind pins must be retained only on the two outer bridge contacts. This is to seal off the pins that are not in use.

Master modules must **not** be connected to one another via the bridge contacts.

The power applied to the external input on the master module supplies the master module and all connected slave modules.

A master module is required to operate a slave module.

Information regarding current consumption:

- a) Maximum of 20 units (19 slaves per master). Maximum current consumption = 20 mA per unit.
- b) Maximum of 10 units (9 slaves per master). Maximum current consumption = 70 mA per unit.
- c) Maximum of 8 units (7 slaves per master). Maximum current consumption = 110 mA per unit.

Pay attention to the protective cover over the bridge contacts of the master modules

Menu structure

Release date: 2023-04-04 Date of issue: 2023-04-04 Filename: 805075_eng.pdf

The menu structure has three levels:

Level 0: Press the "mode"-button. Select the required function via the "±" -button.
Press the "set"-button for confirmation.

Level 1: Select the required function via the "±" -button.
Press the "set"-button to confirm your selection.

Level 2: Use the "±" - button to select the required time delay in 1ms steps.
Press the "set"-button to confirm your selection.

To exit the menu, press the "mode"-button.

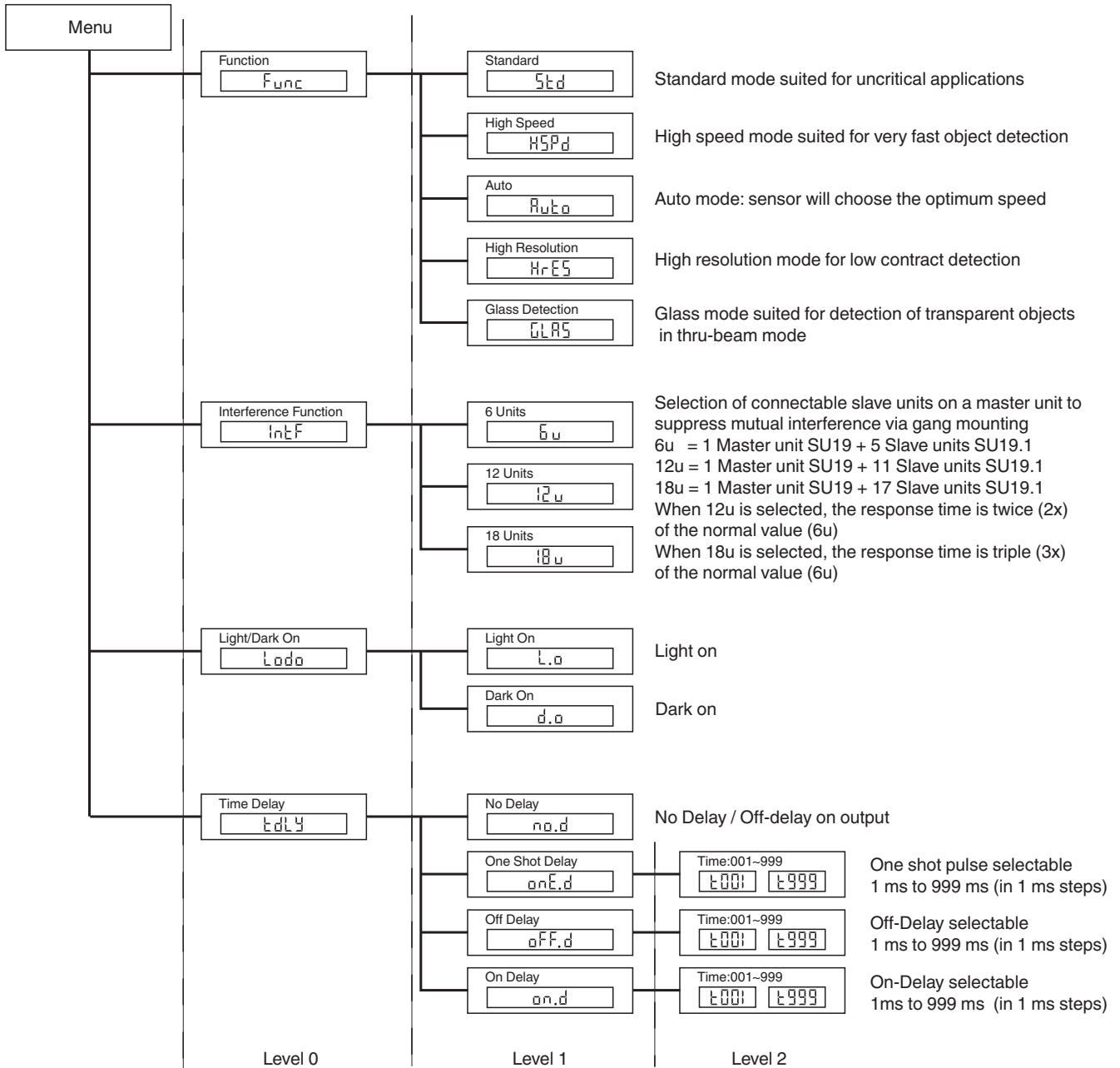

Release date: 2023-04-04 Date of issue: 2023-04-04 Filename: 805075_eng.pdf

Thru-Beam Optical Fiber Selection Table

Refer to "General Notes Relating to Pepperl+Fuchs Product Information".

Head type	Mounting	Designation	Core	Detection range	Fiber cross-section	Minimum object size	Length of fiber optics	Bending radius	Dimensional drawing	Special Properties
Thread	M6	KHE-C01-2.2-2.0-K121	PMMA	200 mm	1.0 mm	0.25 mm	2 m	At least 2 mm		Only 2 mm bending radius
Cylindrical	Dia. 1.5 mm	KHE-C01-1.0-2.0-K139	PMMA	50 mm	0.5 mm	0.05 mm	2 m	At least 1 mm		Only 1 mm bending radius
Cylindrical	Dia. 3 mm	KHE-C01-2.2-2.0-K126	PMMA	50 mm	0.5 mm	0.15 mm	2 m	At least 1 mm		Only 1 mm bending radius
Cylindrical	Dia. 3 mm	KHE-C01-2.2-2.0-K123	PMMA	200 mm	1 mm	0.25 mm	2 m	At least 2 mm		Only 2 mm bending radius
Right angle	Dia. 15 x 5	KHE-C01-2.2-2.0-K137	PMMA	35 mm	0.5 mm	0.15 mm	2 m	At least 1 mm		Only 1 mm bending radius
Right angle	Dia. 15 x 5	KHE-C01-2.2-2.0-K140	PMMA	150 mm	1 mm	0.25 mm	2 m	At least 2 mm		Only 2 mm bending radius
Flexible										
Thread	M3 x 0.5 /M2.6	KLE-C01-1.3-2.0-K112	PMMA	200 mm	1 mm	0.25 mm	2 m	At least 25 mm		Four times higher detection range with auxiliary lens K-LA01/ Lateral optical face with K-LA02
Thread	M3 x 0.5	KLE-C01-2.2-2.0-K103	PMMA	220 mm	1 mm	0.25 mm	2 m	At least 25 mm		
Thread	M4 x 0.7 /M2.6	KLE-C01-2.2-2.0-K102	PMMA	220 mm	1 mm	0.25 mm	2 m	At least 25 mm		Four times higher detection range with auxiliary lens K-LA01/ eight times higher detection range with auxiliary lens K-LA06 Lateral optical face with K-LA02
Thread	M6	KLE-C01-2.2-2.0-K161	PMMA	330 mm	1 mm	0.32 mm	2 m	At least 25 mm		

Release date: 2023-04-04 Date of issue: 2023-04-04 Filename: 805075_eng.pdf

Head type	Mounting	Designation	Core	Detection range	Fiber cross-section	Minimum object size	Length of fiber optics	Bending radius	Dimensional drawing	Special Properties
Thread	M2.6	KLE-C01-2.2-2.0-K113	PMMA	200 mm	1 mm	0.25 mm	2 m	At least 25 mm		Four times higher detection range with auxiliary lens K-LA01/ Lateral optical face with K-LA02
Cylindrical	Dia. 2 mm	KLE-C01-1.3-2.0-K114	PMMA	220 mm	1 mm	0.25 mm	2 m	At least 25 mm		
Cylindrical	Dia. 5 mm	KLE-C01-2.2-2.0-K101	PMMA	220 mm	1 mm	0.32 mm	2 m	At least 25 mm		
Flexible tip										
Thread	M4	KLE 00-2.2-2.0-K55	PMMA	228 mm	1 mm		2 m	At least 25 mm		
Long detection range										
Thread	M3	KLE-C01-2.2-2.0-K116	PMMA	450 mm	1.5 mm	0.35 mm	2 m	At least 40 mm		
Thread	M8 x 1	FEF-PLT1	PMMA	6000 mm calculated value in relation to 2 m fiber optics length	1 mm		1 m	At least 25 mm		Narrow light beam
Thread	M8 x 1	FEF-PLT1-L2	PMMA	6000 mm calculated value in relation to 2 m fiber optics length	1 mm		2 m	At least 25 mm		Narrow light beam
Thread	M8 x 1	FEF-PLT1-L5	PMMA	6000 mm calculated value in relation to 2 m fiber optics length	1 mm		4 m	At least 25 mm		Narrow light beam
Cylindrical	Dia. 3 mm	KLE-C01-2.2-2.0-K117	PMMA	400 mm	1.5 mm	0.35 mm	2 m	At least 25 mm		
Lateral optical face										
Cylindrical	Dia. 4.75 mm	KHE-C01-2.2-2.0-K136	PMMA	50 mm	0.5 mm	0.15 mm	2 m	At least 1 mm		Only 1 mm bending radius

Release date: 2023-04-04 Date of issue: 2023-04-04 Filename: 805075_eng.pdf

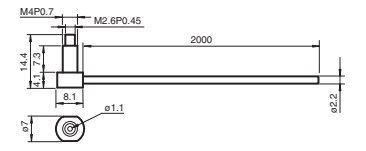
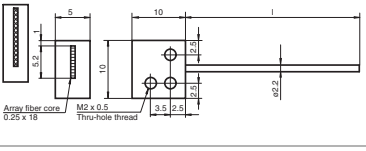
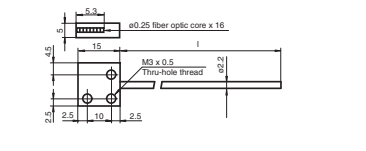
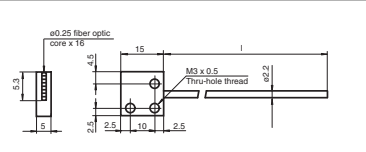
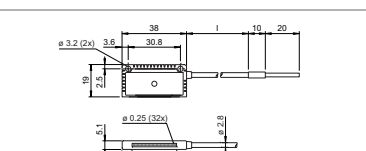
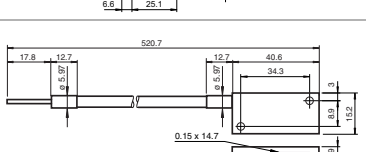
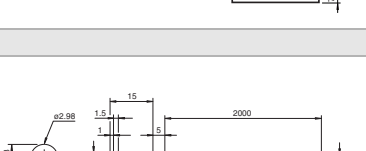
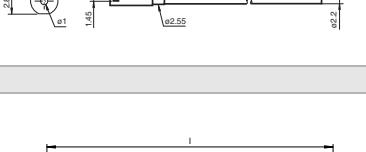
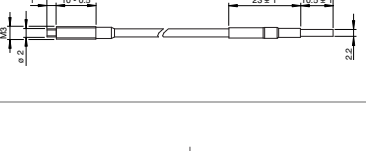
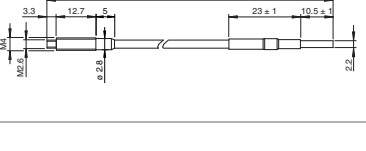
Head type	Mounting	Designation	Core	Detection range	Fiber cross-section	Minimum object size	Length of fiber optics	Bending radius	Dimensional drawing	Special Properties
Right angle	M4	KHE-C01-2.2-2.0-K145	PMMA	112 mm			2 m	At least 2 mm		
Array										
Cubic	3 x M2 x 0.5	KLE-A16-2.2-2.0-K109	PMMA	100 mm	16 x 0.25 mm	0.05 mm	2 m	At least 25 mm		
Cubic	3 x M3 x 0.5	KLE-A16-2.2-2.0-K110	PMMA	100 mm	16 x 0.25 mm	0.05 mm	2 m	At least 25 mm		
Cubic	3 x M3 x 0.5	KLE-A16-2.2-2.0-K111	PMMA	100 mm	16 x 0.25 mm	0.05 mm	2 m	At least 25 mm		
Cubic	2 x 3.2 mm	KLE-A32-2.2-2.0-K142	PMMA	35 mm	32 x 0.25 mm		2 m	At least 25 mm		
Cubic	2 x 3.2 mm	LCE 00-1.6-0.5-K152	Glass	432 mm	0.15 x 14.7		520 m	At least 30 mm		
Resistant to high temperatures										
Cylindrical	Dia. 3 mm	KHTE-C01-2.2-2.0-K118	PMMA	115 mm	1 mm	0.35 mm	2 m	At least 25 mm		- 55 °C ... + 115 °C
Robust design										
Thread	M3	LHE 00-1.1-1.0-14M3	Glass	195 mm	1.1 mm		1 m	4 mm static		- 40 °C ... + 180 °C
Thread	M4 x 0.7 /M2.6	LHE 00-1.1-1.0-20M4	Glass	195 mm	1.1 mm		1 m	4 mm static		Four times higher detection range with auxiliary lens K-LA01/ eight times higher detection range with auxiliary lens K-LA06 Lateral optical face with K-LA02/ - 40 °C ... + 180 °C
Thread	M6	LHE 00-1.1-1.0-G	Glass	195 mm	1.1 mm		1 m	4 mm static		- 40 °C ... + 180 °C

Release date: 2023-04-04 Date of issue: 2023-04-04 Filename: 805075_eng.pdf

Refer to "General Notes Relating to Pepperl+Fuchs Product Information".

Pepperl+Fuchs Group
www.pepperl-fuchs.com

USA: +1 330 486 0001
fa-info@us.pepperl-fuchs.com

Germany: +49 621 776 1111
fa-info@de.pepperl-fuchs.com

Singapore: +65 6779 9091
fa-info@sg.pepperl-fuchs.com

 PEPPERL+FUCHS

Head type	Mounting	Designation	Core	Detection range	Fiber cross-section	Minimum object size	Length of fiber optics	Bending radius	Dimensional drawing	Special Properties
Thread	M4 x 0.7/M2.6	LME 00-1.0-1.0-K151	Glass	144 mm	1 mm		1 m	30 mm static		Temperature-resistant up to 350 °C (end segment, interval) Four times higher detection range with auxiliary lens K-LA01/ eight times higher detection range with auxiliary lens K-LA06 Lateral optical face with K-LA02
Cylindrical	Dia. 1.5 mm	LHE 00-1.1-1.0-10C1.5	Glass	195 mm	1.1 mm		1 m	4 mm static		- 40 °C ... + 180 °C
Cylindrical	Dia. 3 mm	LHE 00-1.1-1.0-15C3	Glass	195 mm	1.1 mm		1 m	4 mm static		- 40 °C ... + 180 °C
Right angle	M4 x 0.7/M2.6	LME 00-1.2-1.0-K153	Glass	144 mm	1.2 mm		1 m	30 mm static		Temperature-resistant up to 350 °C (end segment, interval)
Special design										
Cubic	2 x 2.2 mm	KHE-A01-1.0-2.0-K138	PMMA	25 mm	0.5 mm	0.05 mm	2 m	At least 1 mm		Only 1 mm bending radius
Fork	2 x 3.2 mm	KLE-C02-1.25-2.0-K134	PMMA	5 mm	2 x 0.25 mm		2 m	At least 10 mm		
Fork	2 x 3.2 mm	KLE-C02-1.25-2.0-K135	PMMA	10 mm	2 x 0.25 mm		2 m	At least 10 mm		



Using the high-speed mode or glass detection mode halves the detection range.

Diffuse Mode Sensor Selection Table

Head type	Mounting	Designation	Core	Sensing range	Fiber cross-section	Length of fiber optics	Bending radius	Dimensional drawing	Special Properties	
High-precision										
Thread	M3 x 0.5	KLR-C02-1.0-2.0-K75	PMMA	4 mm	2 x 0.25 m	2 m	At least 10 mm			

Release date: 2023-04-04 Date of issue: 2023-04-04 Filename: 805075_eng.pdf

Refer to "General Notes Relating to Pepperl+Fuchs Product Information".

Pepperl+Fuchs Group
www.pepperl-fuchs.com

USA: +1 330 486 0001
fa-info@us.pepperl-fuchs.com

Germany: +49 621 776 1111
fa-info@de.pepperl-fuchs.com

Singapore: +65 6779 9091
fa-info@sg.pepperl-fuchs.com

PEPPERL+FUCHS

Head type	Mounting	Designation	Core	Sensing range	Fiber cross-section	Length of fiber optics	Bending radius	Dimensional drawing	Special Properties
Thread	M4 x 0.7	KLR-C02-1.0-2.0-K73	PMMA	4 mm	2 x 0.25 mm	2 m	At least 10 mm		
Thread	M3 x 0.5	KLR-C04-1.25-2.0-K78	PMMA	8 mm	4 x 0.25 m	2 m	At least 15 mm		
Cylindrical	Dia. 2.0 mm	KLR-C02-1.0-2.0-K91	PMMA	4 mm	2 x 0.25 mm	2 m	At least 10 mm		
Cylindrical	Dia. 3.0 mm	KLR-C02-1.0-2.0-K90	PMMA	4 mm	2 x 0.25 mm	2 m	At least 10 mm		
Cylindrical	Dia. 1.5 mm	KLR-C04-1.25-2.0-K80	PMMA	8 mm	4 x 0.25 mm	2 m	At least 15 mm		
Cylindrical	Dia. 1.5 mm	KLR-C04-1.0-2.0-K133	PMMA	7 mm	4 x 0.25 mm	2 m	At least 15 mm		
Cylindrical	Dia. 2.0 mm	KLR-C02-1.0-2.0-K87	PMMA	25 mm	2 x 0.5 mm	2 m	At least 15 mm		
Cylindrical	Dia. 3.0 mm	KLR-C04-1.25-2.0-K79	PMMA	8 mm	4 x 0.25 mm	2 m	At least 15 mm		
Coaxial									
Thread	M3 x 0.5	KLR-C09-1.25-2.0-K76	PMMA	30 mm	1 x 0.5 mm emitter 9 x 0.25 mm receiver	2 m	At least 15 mm		Only 0.5 mm light spot at 8 mm With auxiliary lens K-LA03
Thread	M4 x 0.7 /M2.6	KLR-C09-1.25-2.0-K74	PMMA	30 mm	1 x 0.5 mm emitter 9 x 0.25 mm receiver	2 m	At least 15 mm		Only 0.7 mm light spot at 10 mm with auxiliary lens K-LA04/ two times higher detection range with auxiliary lens K-LA01/ three times higher detection range with auxiliary lens K-LA06
Thread	M6 x 0.75	KLR-C16-2.2-2.0-K71	PMMA	85 mm	1 x 1.0 mm emitter 16 x 0.25 mm receiver	2 m	At least 25 mm		

Release date: 2023-04-04 Date of issue: 2023-04-04 Filename: 805075_eng.pdf

Refer to "General Notes Relating to Pepperl+Fuchs Product Information".

Pepperl+Fuchs Group
www.pepperl-fuchs.com

USA: +1 330 486 0001
fa-info@us.pepperl-fuchs.com

Germany: +49 621 776 1111
fa-info@de.pepperl-fuchs.com

Singapore: +65 6779 9091
fa-info@sg.pepperl-fuchs.com

PEPPERL+FUCHS

Head type	Mounting	Designation	Core	Sensing range	Fiber cross-section	Length of fiber optics	Bending radius	Dimensional drawing	Special Properties
Cylindrical	Dia. 1.0 mm	KLR-C06-1.25-2.0-K81	PMMA	20 mm	1 x 0.25 mm emitter 6 x 0.25 mm receiver	2 m	At least 15 mm		
Cylindrical	Dia. 3.0 mm	KLR-C09-1.25-2.0-K77	PMMA	30 mm	1 x 0.5 mm emitter 9 x 0.25 mm receiver	2 m	At least 15 mm		
Cylindrical	Dia. 5.0 mm	KLR-C16-2.2-2.0-K72	PMMA	85 mm	1 x 1.0 mm emitter 16 x 0.25 mm Receiver	2 m	At least 25 mm		
Highly flexible									
Thread	M3	KHR-C02-1.0-2.0-K96	PMMA	12 mm	2 x 0.5 mm	2 m	At least 1 mm		
Thread	M4	KHR-C02-1.0-2.0-K95	PMMA	12 mm	2 x 0.5 mm	2 m	At least 1 mm		
Thread	M4	KHR-C02-1.3-2.0-K92	PMMA	60 mm	2 x 1.0 mm	2 m	At least 2 mm		
Thread	M6	KHR-C02-2.2-2.0-K94	PMMA	12 mm	2 x 0.5 mm	2 m	At least 1 mm		
Cylindrical	Dia. 3.0 mm	KHR-C02-1.3-2.0-K93	PMMA	60 mm	2 x 1.0 mm	2 m	At least 2 mm		
Flexible									
Thread	M6 x 0.75	KLR-C02-2.2-2.0-K70	PMMA	80 mm	2 x 1.0 mm	2 m	At least 25 mm		
Cylindrical	Dia. 3.0 mm	KLR-C02-1.3-2.0-K86	PMMA	80 mm	2 x 1.0 mm	2 m	At least 25 mm		
Cylindrical	Dia. 5.0 mm	KLR-C02-2.2-2.0-K85	PMMA	80 mm	2 x 1.0 mm	2 m	At least 25 mm		

Release date: 2023-04-04 Date of issue: 2023-04-04 Filename: 805075_eng.pdf

Head type	Mounting	Designation	Core	Sensing range	Fiber cross-section	Length of fiber optics	Bending radius	Dimensional drawing	Special Properties
Flexible tip									
Thread	M3 x 0.5	KLR 00-1.0-2.0-K58	PMMA	20 mm		2 m	At least 15 mm		
Thread	M6	KLR 00-2.2-2.0-K57	PMMA	60 mm		2 m	At least 15 mm		
Long detection range									
Thread		KLR-C02-2.2-2.0-K146	PMMA	150 mm		2 m	At least 40 mm		
Thread		KLR-C10-1.25-2.0-K144	PMMA	30 mm		2 m	At least 15 mm		
Lateral optical face									
Thread	M6	KHR-C02-2.2-2.0-K131	PMMA	60 mm	2 x 1.0 mm	2 m	At least 2 mm		Only 2 mm bending radius
Thread	Dia. 5.0 mm	KHR-C02-1.0-2.0-K132	PMMA	15 mm	2 x 0.5 mm	2 m	At least 1 mm		Only 1 mm bending radius
Array									
Cubic	3 x M2 x 0.5	KLR-A18-1.3-2.0-K82	PMMA	25 mm	18 x 0.25 mm	2 m	At least 25 mm		
Cubic	3 x M3 x 0.5	KLR-A32-2.2-2.0-K83	PMMA	35 mm	10.85 mm	2 m	At least 25 mm		
Cubic	2 x 3.2 mm	KLR-A32-2.2-2.0-K141	PMMA	35 mm	16 x 0.25 mm	2 m	At least 25 mm		
Resistant to high temperatures									
Thread	M6	KHTR-C02-2.2-2.0-K88	PMMA	80 mm	2 x 1.0 mm	2 m	At least 25 mm		- 55 °C ... + 115 °C

Release date: 2023-04-04 Date of issue: 2023-04-04 Filename: 805075_eng.pdf

Refer to "General Notes Relating to Pepperl+Fuchs Product Information".

Pepperl+Fuchs Group
www.pepperl-fuchs.com

USA: +1 330 486 0001
fa-info@us.pepperl-fuchs.com

Germany: +49 621 776 1111
fa-info@de.pepperl-fuchs.com

Singapore: +65 6779 9091
fa-info@sg.pepperl-fuchs.com

PEPPERL+FUCHS

Head type	Mounting	Designation	Core	Sensing range	Fiber cross-section	Length of fiber optics	Bending radius	Dimensional drawing	Special Properties
Cylindrical	Dia. 5.0 mm	KHTR-C02-2.2-2.0-K89	PMMA	80 mm	2 x 1.0 mm	2 m	At least 25 mm		-55 °C ... +115 °C
Robust design									
Thread	M3 x 0.5	LHR 00-0.8-1.0-14M3	Glass	40 mm	0.8 mm	1 m	4 mm static		-40 °C ... +180 °C
Thread	M4 x 0.7	LHR 00-0.8-1.0-20M4	Glass	40 mm	0.8 mm	1 m	4 mm static		-40 °C ... +180 °C
Thread	M6	LHR 00-1.1-1.0-G	Glass	70 mm	1.1 mm	1 m	4 mm static		-40 °C ... +180 °C
Cylindrical	Dia. 4.5 mm	LHR 00-1.1-1.0-K1	Glass	70 mm	1.1 mm	1 m	4 mm static		-40 °C ... +180 °C
Special design									
Cubic		KHR-C02-1.0-2.0-K129	PMMA	5 ~ 10 mm	2 x 0.5 mm	2 m	At least 1 mm		Crossed light beam for background suppression Only 1 mm bending radius
Cubic		KLR-C02-1.3-2.0-K130	PMMA	1 ~ 8 mm	2 x 1.0 mm	2 m	At least 25 mm		Crossed light beam for background suppression
Cubic	3 x M3 x 0.5	KHR-A02-2.2-2.0-K127	PMMA	50 mm	2 x 1.0 mm	2 m	At least 2 mm		Only 2 mm bending radius
Cubic		KLR-C02-1.25-2.0-K128	PMMA	4 ~ 26 mm	2 x 0.5 mm	2 m	At least 15 mm		Fill level measurement
Cylindrical		KLR-C02-1.25-2.0-K147	PMMA			2 m	At least 40 mm		Fill level detection

 Using the high-speed mode or glass detection mode halves the detection range.

Release date: 2023-04-04 Date of issue: 2023-04-04 Filename: 805075_eng.pdf