

Retroreflective sensor

MLV12-54/49/124

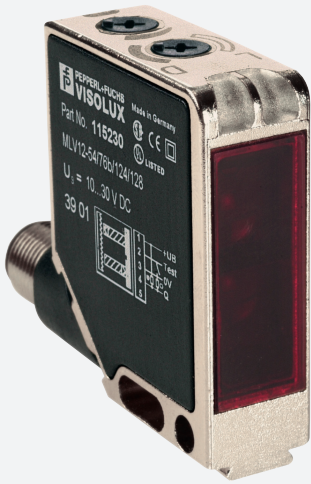
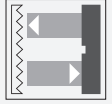

- Robust photoelectric sensor series in a widely used standard housing
- Resistant against noise: reliable operation under all conditions
- Clear and functional display concept for the operating modes
- High level of stability thanks to the metal housing frame
- Tightly sealed thanks to welded plastic components
- Suitable for operation at low temperatures down to -40 °C

Robust retroreflective sensor for complex applications, small design, polarization filter, 9 m detection range, red light, light/dark on, 1 PNP output/1 NPN output, M12 plug



Dimensions

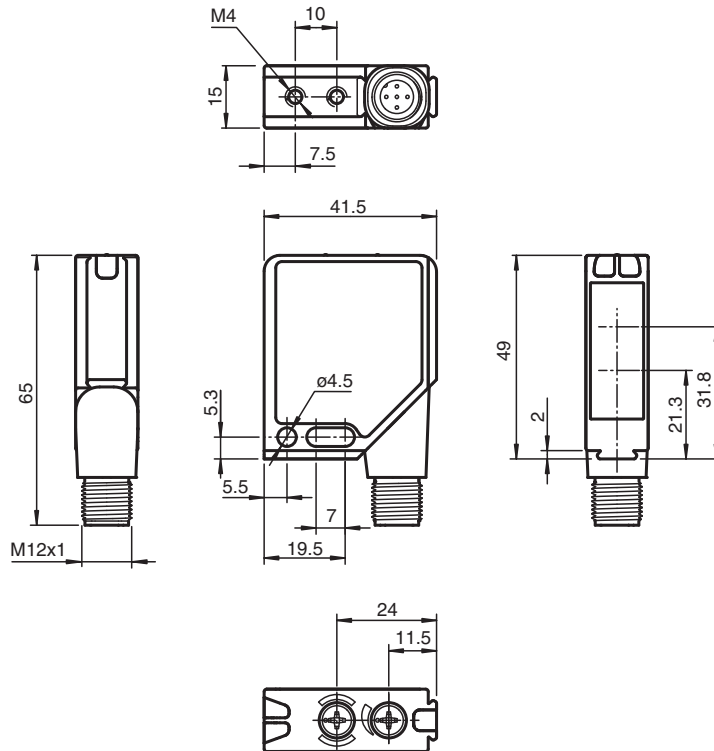

Release date: 2023-04-04 Date of issue: 2023-04-04 Filename: 115228_eng.pdf

Refer to "General Notes Relating to Pepperl+Fuchs Product Information".

Pepperl+Fuchs Group
www.pepperl-fuchs.com

USA: +1 330 486 0001
fa-info@us.pepperl-fuchs.com

Germany: +49 621 776 1111
fa-info@de.pepperl-fuchs.com

Singapore: +65 6779 9091
fa-info@sg.pepperl-fuchs.com

pepperl+fuchs

Technical Data

General specifications		
Effective detection range		0 ... 6.5 m
Reflector distance		0.01 ... 6.5 m
Threshold detection range		9 m
Reference target		H85-2 reflector
Light source		LED
Light type		modulated visible red light , 660 nm
Polarization filter		yes
Diameter of the light spot		approx. 170 mm at detection range 6.5 m
Opening angle		1.5 °
Ambient light limit		
Continuous light		50000 Lux
Modulated light		5000 Lux
Functional safety related parameters		
MTTF _d		1000 a
Mission Time (T _M)		20 a
Diagnostic Coverage (DC)		0 %
Indicators/operating means		
Operation indicator		LED green, flashes in case of short-circuit
Function indicator		2 LEDs yellow, light up when light beam is free, flash when falling short of the stability control, off when light beam is interrupted
Control elements		rotary switch for light/dark, sensitivity adjuster
Electrical specifications		
Operating voltage	U _B	10 ... 30 V DC
Ripple		max. 10 %
No-load supply current	I ₀	max. 40 mA
Output		
Switching type		light/dark on switchable
Signal output		1 NPN and 1 PNP output, direct switching, short-circuit protected, reverse polarity protected, open collector
Switching voltage		max. 30 V DC
Switching current		max. 0.2 A
Voltage drop	U _d	≤ 2.5 V DC
Switching frequency	f	1000 Hz
Response time		0.5 ms
Conformity		
Product standard		EN 60947-5-2
Compliance with standards and directives		
Standard conformity		
Shock and impact resistance		IEC / EN 60068. half-sine, 40 g in each X, Y and Z directions
Vibration resistance		IEC / EN 60068-2-6. Sinus. 10 -150 Hz, 5 g in each X, Y and Z directions
Approvals and certificates		
Protection class		II, rated voltage ≤ 300 V AC with pollution degree 1-2 according to IEC 60664-1
UL approval		cULus
CCC approval		CCC approval / marking not required for products rated ≤36 V
Ambient conditions		
Ambient temperature		-40 ... 60 °C (-40 ... 140 °F)
Storage temperature		-40 ... 75 °C (-40 ... 167 °F)
Mechanical specifications		
Housing width		41.5 mm
Housing height		49 mm
Housing depth		15 mm
Degree of protection		IP67

Release date: 2023-04-04 Date of issue: 2023-04-04 Filename: 115228_eng.pdf

Technical Data

Connection	Metal connector, M12, 5-pin, 90° rotatable
Material	
Housing	Frame: nickel plated, die cast zinc, Laterals: glass-fiber reinforced plastic PC
Optical face	Plastic pane
Mass	60 g

Connection

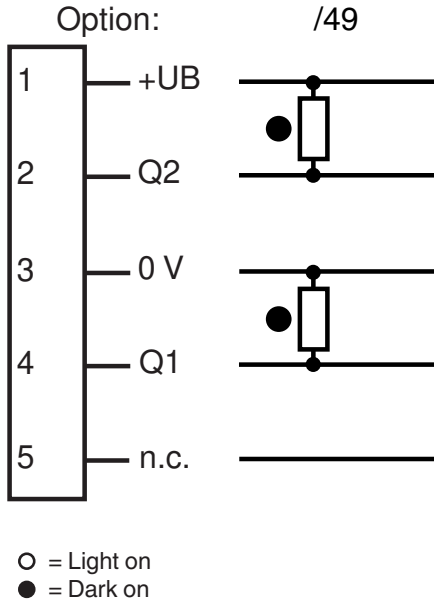

Connection Assignment

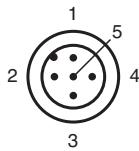

Wire colors in accordance with EN 60947-5-2

1	BN	(brown)
2	WH	(white)
3	BU	(blue)
4	BK	(black)
5	GY	(gray)

Assembly

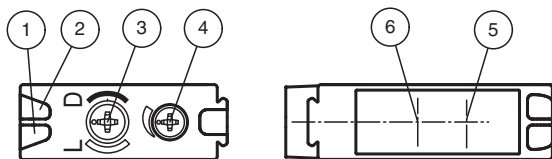

1	Operating display	green
2	Switch state	yellow
3	Light/dark switch	
4	Sensitivity adjuster	
5	Optical axis emitter	
6	Optical axis receiver	

Release date: 2023-04-04 Date of issue: 2023-04-04 Filename: 115228_eng.pdf

Refer to "General Notes Relating to Pepperl+Fuchs Product Information".

Installation

Mounting

The sensors can be secured directly using thru-holes or using a mounting bracket or mounting clamp. Mounting brackets and clamping elements are available as accessories. Ensure that the background is level to prevent the housing from becoming distorted when the fittings are tightened. Secure the nut and screw with spring disks to prevent the sensor from becoming misaligned.

Characteristic Curve

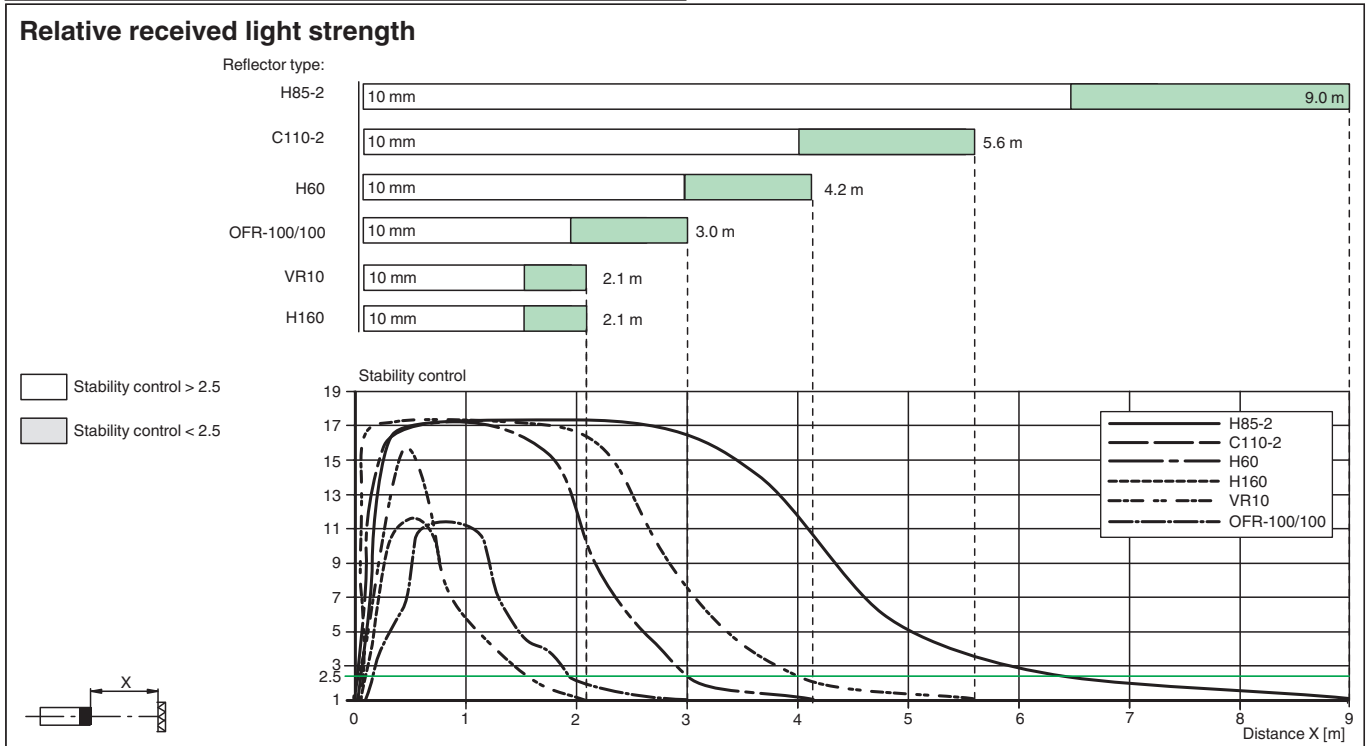
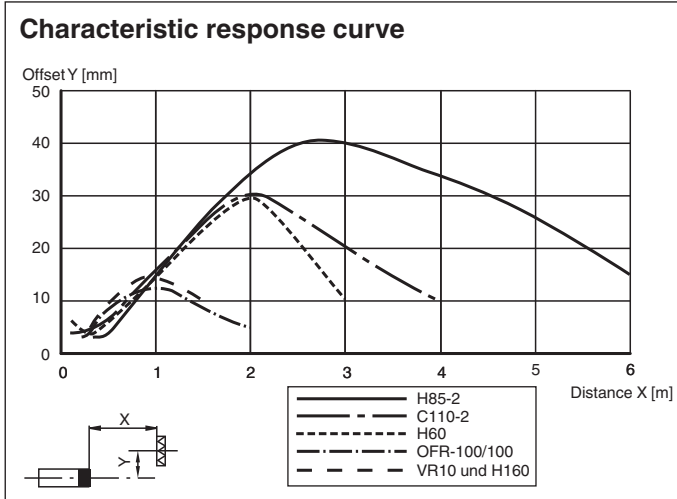

System Description

System Description

The retro-reflective sensor contains both an emitter and a receiver in a single housing. A reflector reflects the light from emitter back to the receiver. If an object interrupts the light beam, the switching function is initiated.

Commissioning

Aligning the sensor: Apply the operating voltage to the sensor. The operating indicator lights up green. Mount a suitable reflector opposite the light barrier. Roughly align the sensor (without an object) with the reflector. Next, adjust the sensor to the reflector by swiveling the sensor horizontally and vertically so that the yellow signal indicator lights up continuously. In the event of misalignment, the yellow signal indicator flashes.

Release date: 2023-04-04 Date of issue: 2023-04-04 Filename: 115228_eng.pdf

Commissioning

Checking object detection: Follow the steps below to check that the sensor detects objects as required.

Position the object in the beam path of the sensor.

When the object is detected, the yellow signal indicator goes out. If the yellow signal indicator remains lit, reduce the sensitivity of the potentiometer until the yellow signal indicator goes out.

When the object disappears from the beam path of the sensor, the yellow signal indicator lights up again continuously.







Maintenance

Maintenance

Cleaning: If the transmission reception deteriorates, e.g., due to dirt, the yellow signal indicator on the receiver flashes. Clean the optical interfaces of the sensor (e.g., lenses) at regular intervals.

Maintenance: Check the mounting fittings and the electrical connections regularly.

Accessories

	OMH-MLV12-HWG	Mounting bracket for series MLV12 sensors
	OMH-MLV12-HWK	Mounting bracket for series MLV12 sensors
	OMH-K01	dove tail mounting clamp
	OMH-K02	dove tail mounting clamp
	OMH-K03	dove tail mounting clamp
	OMH-06	Mounting aid for round steel \varnothing 12 mm or sheet 1.5 mm ... 3 mm