



Thru-beam sensor (pair)

OBE35M-R202-SE2-V1-Y70148119



- Medium design with versatile mounting options
- Degree of protection IP67
- Mounting on full metal sockets
- Very bright, highly visible light spot
- Highly visible LEDs for Power ON and switching state
- Easy to use
- Image is generic for this device type and may deviate from the specific variant



Function

The optical sensors of this series for applications in standard automation have a modern housing design. The sensors are characterized by the many mounting options, easy handling and highly visible LED status indicators. The integrated full metal bushings ensure long-term secure and dimensionally stable mounting.

Dimensions

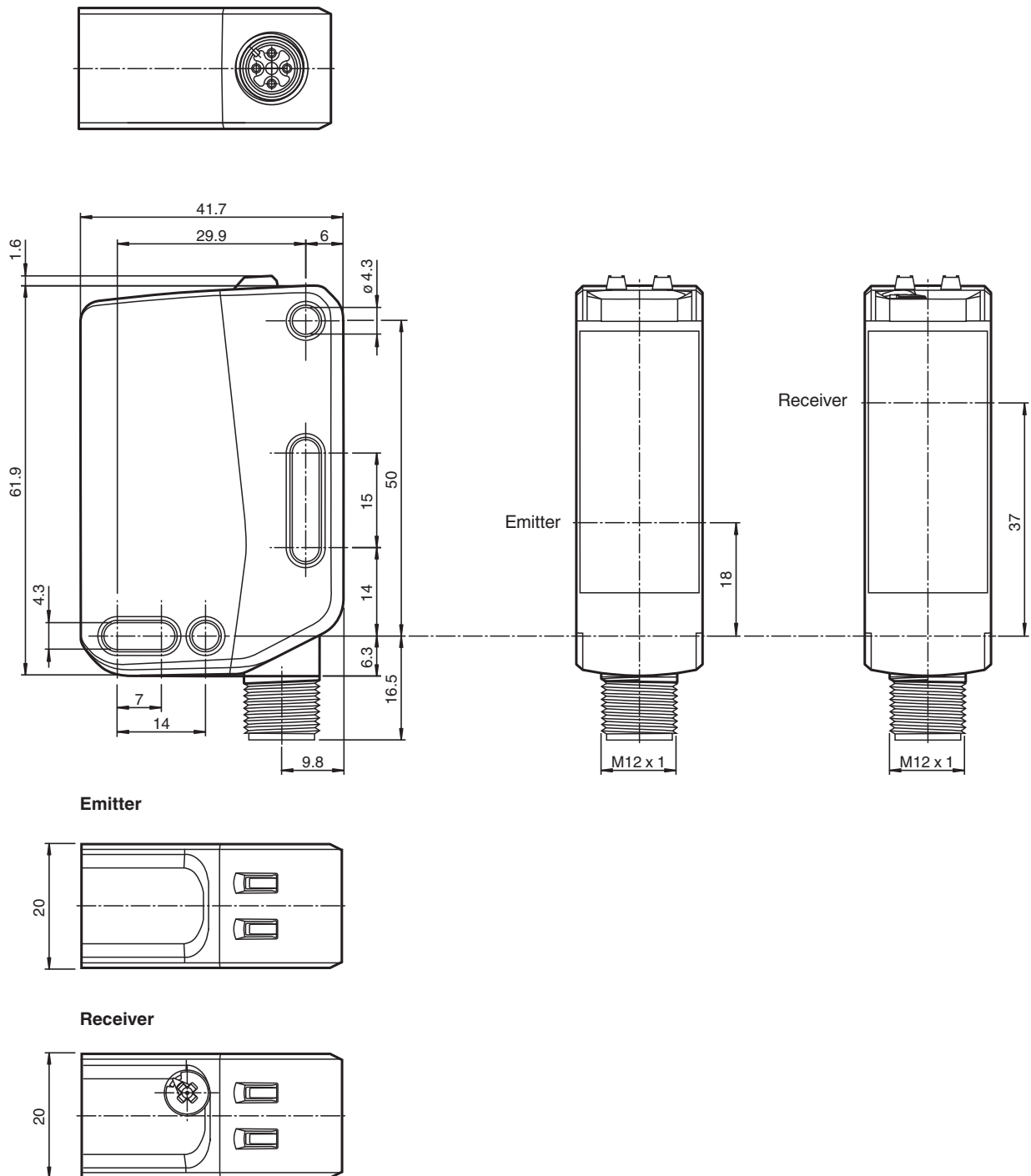

Release date: 2023-03-28 Date of issue: 2023-03-28 Filename: 70148119_eng.pdf

Technical Data

System components	
Emitter	OBE35M-R202-S-V1
Receiver	OBE35M-R202-E2-V1-Y0039
General specifications	
Effective detection range	0 ... 35 m
Threshold detection range	47 m
Light source	LED
Light type	modulated visible red light

Refer to "General Notes Relating to Pepperl+Fuchs Product Information".

Technical Data

LED risk group labelling		exempt group
Transmitter frequency		F1 = 8.2 kHz
Diameter of the light spot		approx. 1200 mm at a distance of 35 m
Opening angle		2 °
Ambient light limit		EN 60947-5-2 : 40000 Lux
Functional safety related parameters		
MTTF _d		656 a
Mission Time (T _M)		20 a
Diagnostic Coverage (DC)		0 %
Indicators/operating means		
Operation indicator		LED green: on - power on flashing (4 Hz) - short circuit
Function indicator		Yellow LED: Permanently lit - light path clear Permanently off - object detected Flashing (4 Hz) - insufficient operating reserve Flashing (8 Hz) - fault detected, the outputs maintain the status
Control elements		Receiver: sensitivity adjustment
Electrical specifications		
Operating voltage	U _B	10 ... 30 V DC
Ripple		max. 10 %
No-load supply current	I ₀	Emitter: ≤ 25 mA Receiver: ≤ 40 mA at 24 V Operating voltage
Protection class		III
Input		
Test input		emitter deactivation at +U _B
Output		
Switching type		Q - Pin4: PNP normally open / dark-on
Signal output		1 PNP output, short-circuit protected, reverse polarity protected, open collector
Switching voltage		max. 30 V DC
Switching current		max. 100 mA , resistive load
Usage category		DC-12 and DC-13
Voltage drop	U _d	≤ 1.5 V DC
Switching frequency	f	1000 Hz
Response time		0.5 ms
Conformity		
Product standard		EN 60947-5-2
Approvals and certificates		
UL approval		E87056 , cULus Listed , class 2 power supply , type rating 1
CCC approval		CCC approval / marking not required for products rated ≤36 V
Ambient conditions		
Ambient temperature		-30 ... 60 °C (-22 ... 140 °F)
Storage temperature		-40 ... 70 °C (-40 ... 158 °F)
Mechanical specifications		
Housing width		20 mm
Housing height		62 mm
Housing depth		42 mm
Degree of protection		IP67
Connection		4-pin, M12 x 1 connector
Material		
Housing		PC (Polycarbonate)
Optical face		PMMA

Release date: 2023-03-28 Date of issue: 2023-03-28 Filename: 70148119_eng.pdf

Technical Data

Mass	Emitter: approx. 50 g receiver: approx. 55 g
------	---

Connection

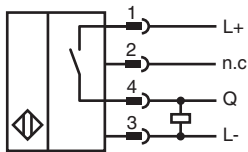
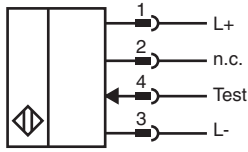

Connection Assignment

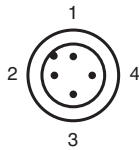

Wire colors in accordance with EN 60947-5-2

1		BN	(brown)
2		WH	(white)
3		BU	(blue)
4		BK	(black)

Indication

Emitter

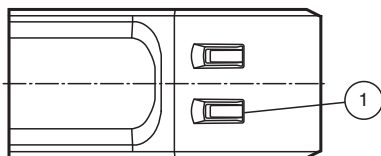

1	Operation indicator	GN
---	---------------------	----

Receiver

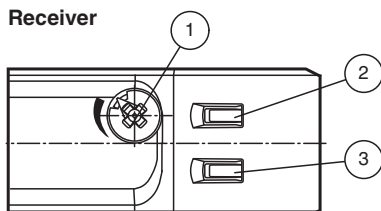

1	Sensitivity adjuster	
2	Signal indicator	YE
3	Operation indicator	GN

Release date: 2023-03-28 Date of issue: 2023-03-28 Filename: 70148119_eng.pdf

Characteristic Curve

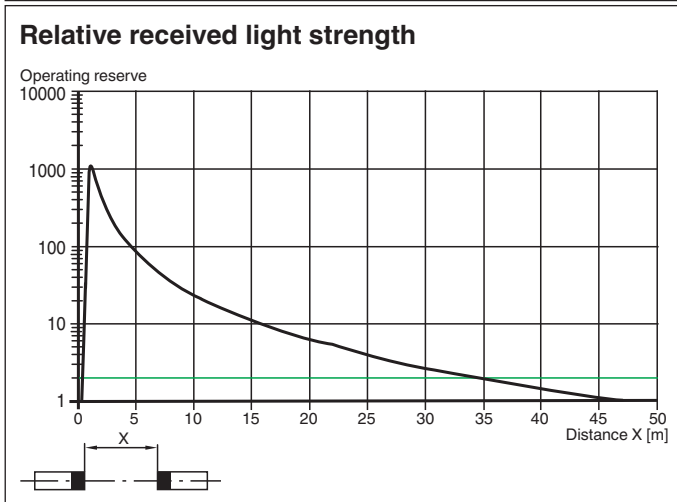
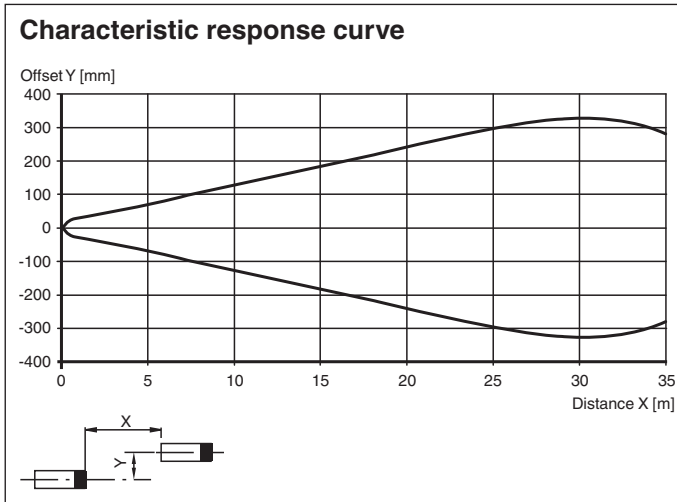

Commissioning

Sensing Range / Sensitivity

Turn sensing range / sensitivity adjuster clockwise to increase sensing range / sensitivity.
 Turn sensing range / sensitivity adjuster counter clockwise to decrease sensing range / sensitivity.

Accessories

	<p>OMH-RL31-02</p>	<p>Mounting bracket narrow</p>
---	---------------------------	--------------------------------

Release date: 2023-03-28 Date of issue: 2023-03-28 Filename: 70148119_eng.pdf