



## Diffuse mode sensor ML300-8-1200-IR/25/95/120



- Miniature design
- Easy to use
- Infrared light
- High operating range
- 45° connector

Diffuse mode sensor



### Function

The ML300 series has a robust miniature housing and all the standard functional principles. Of particular note are the sensors with analog output, which return a value proportional to the distance. The 45° plug/cable connection ensures flexible mounting. An LED indicates a weak signal, e.g. due to dirt.

### Dimensions

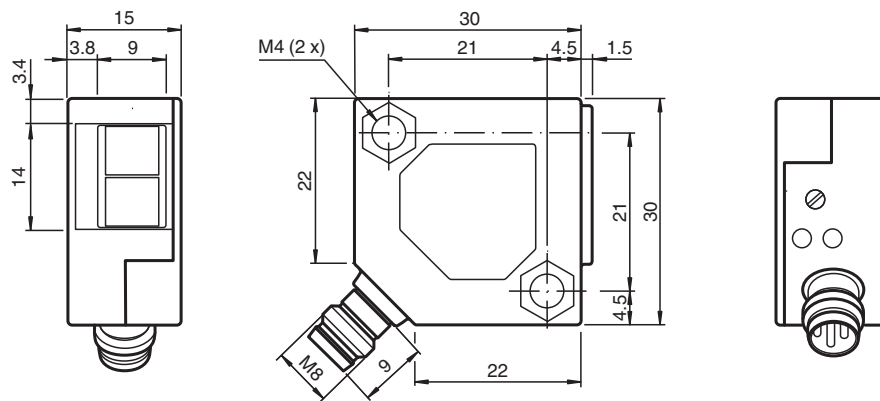

Release date: 2023-02-27 Date of issue: 2023-02-27 Filename: 238221\_eng.pdf

Refer to "General Notes Relating to Pepperl+Fuchs Product Information".

Pepperl+Fuchs Group  
www.pepperl-fuchs.com

USA: +1 330 486 0001  
fa-info@us.pepperl-fuchs.com

Germany: +49 621 776 1111  
fa-info@de.pepperl-fuchs.com

Singapore: +65 6779 9091  
fa-info@sg.pepperl-fuchs.com

**PF** PEPPERL+FUCHS

## Technical Data

General specifications		
Detection range		0 ... 1200 mm , adjustable
Adjustment range		250 ... 1200 mm
Reference target		standard white 200 mm x 200 mm
Light source		IREd
Light type		modulated infrared light , 880 nm
Diameter of the light spot		approx. 160 mm at a distance of 1200 mm
Opening angle		approx. 8 °
Ambient light limit		
Continuous light		10000 Lux
Modulated light		5000 Lux
Accessories provided		Mounting bracket OMH-ML300-01
Indicators/operating means		
Function indicator		LED yellow: lights up when output is active LED green: Sufficient stability control
Control elements		Sensing range adjuster
Electrical specifications		
Operating voltage	$U_B$	10 ... 30 V DC
Ripple		max. 20 %
No-load supply current	$I_0$	max. 20 mA
Output		
Switching type		light on / dark on
Signal output		2 PNP outputs, complementary, short-circuit protected, reverse polarity protected, open collector
Switching voltage		max. 30 V DC
Switching current		max. 0.1 A
Voltage drop	$U_d$	$\leq 2$ V DC
Switching frequency	$f$	1000 Hz
Response time		0.5 ms
Conformity		
Product standard		EN 60947-5-2
Compliance with standards and directives		
Standard conformity		
Shock and impact resistance		EN 60947-5-7 30 g, 11 ms, all axes
Vibration resistance		EN 60947-5-7, 10-55 Hz/1.5 mm amplitude, all axes
Approvals and certificates		
CCC approval		CCC approval / marking not required for products rated $\leq 36$ V
Ambient conditions		
Ambient temperature		-25 ... 55 °C (-13 ... 131 °F)
Mechanical specifications		
Housing width		30 mm
Housing height		30 mm
Housing depth		15 mm
Degree of protection		IP67
Connection		M8 x 1 connector, 4-pin
Material		
Housing		PBT
Optical face		glass pane
Connector		metal
Mass		18 g

Release date: 2023-02-27 Date of issue: 2023-02-27 Filename: 238221\_eng.pdf

## Connection Assignment

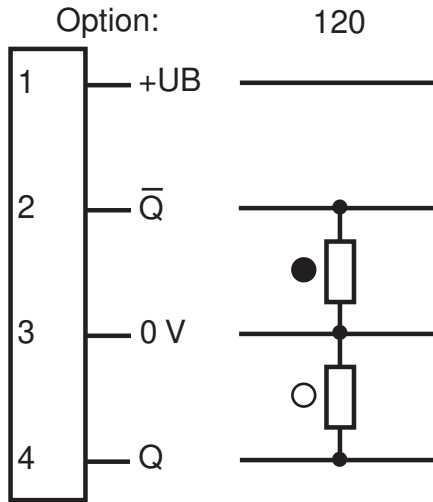

○ = Light on  
● = Dark on

## Connection Assignment



Wire colors in accordance with EN 60947-5-2

- |   |  |    |         |
|---|--|----|---------|
| 1 |  | BN | (brown) |
| 2 |  | WH | (white) |
| 3 |  | BU | (blue)  |
| 4 |  | BK | (black) |

## Assembly

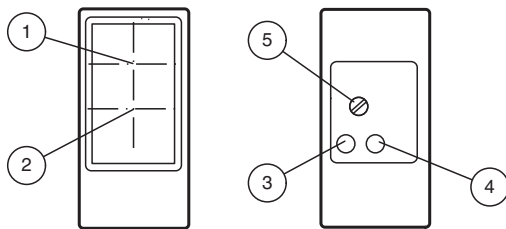



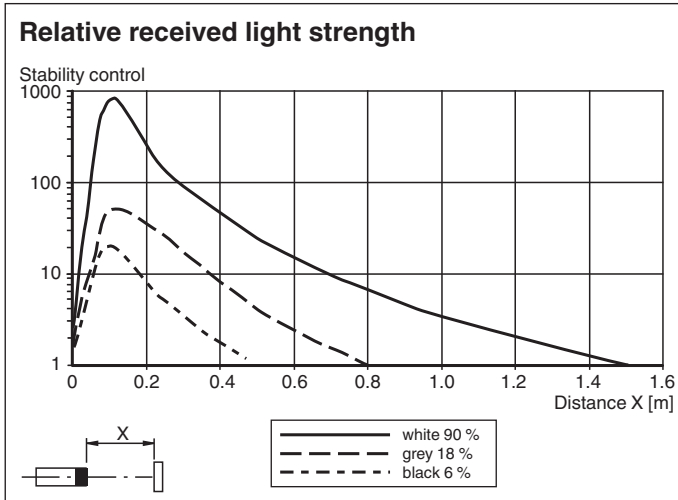
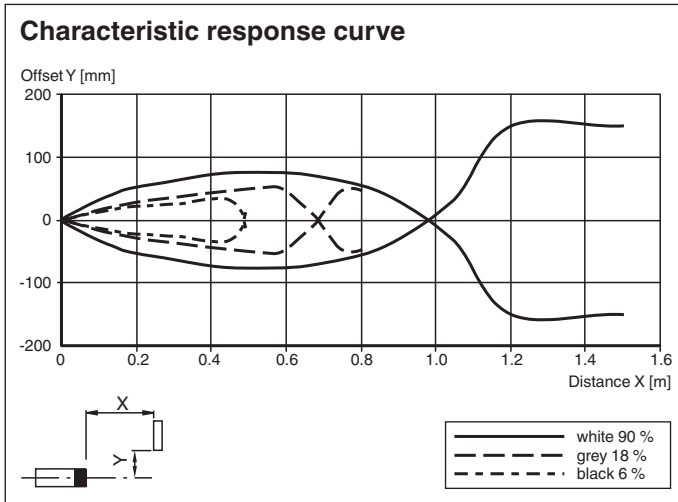

1	Receiver	
2	Emitter	
3	Switching state	yellow
4	Stability control	green
5	Sensing range adjuster	

Release date: 2023-02-27 Date of issue: 2023-02-27 Filename: 238221\_eng.pdf

**Characteristic Curve**



**Accessories**

	<b>OMH-ML300-01</b>	Bracket for mounting ML300 series sensors
	<b>V31-GM-2M-PVC</b>	Female cordset single-ended M8 straight A-coded, 4-pin, PVC cable grey
	<b>V31-WM-2M-PVC</b>	Female cordset single-ended M8 angled A-coded, 4-pin, PVC cable grey
	<b>V31-WM-2M-PUR</b>	Female cordset single-ended M8 angled A-coded, 4-pin, PUR cable grey
	<b>V31-GM-2M-PUR</b>	Female cordset single-ended M8 straight A-coded, 4-pin, PUR cable grey

Release date: 2023-02-27 Date of issue: 2023-02-27 Filename: 238221\_eng.pdf