



## Distance sensor

### OMT300-R200-EP-IO-0,3M-V3-L



- Medium design with versatile mounting options
- Space-saving distance sensors in small standardized design
- Multi Pixel Technology (MPT) - exact and precise signal evaluation
- IO-Link interface for service and process data

Distance sensor



# IO-Link

## Function

The optical sensors in the series are the first devices to offer an end-to-end solution in a medium-sized standard design – from the thru-beam sensor through to the measuring distance sensor. As a result of this design, the sensors are able to perform practically all standard automation tasks.

The entire series enables sensors to communicate via IO-Link.

The DuraBeam laser sensors are durable and can be used in the same way as a standard sensor.

Multi Pixel Technology (MPT) ensures that the standard sensors are flexible and can be adapted to the application environment.

## Dimensions

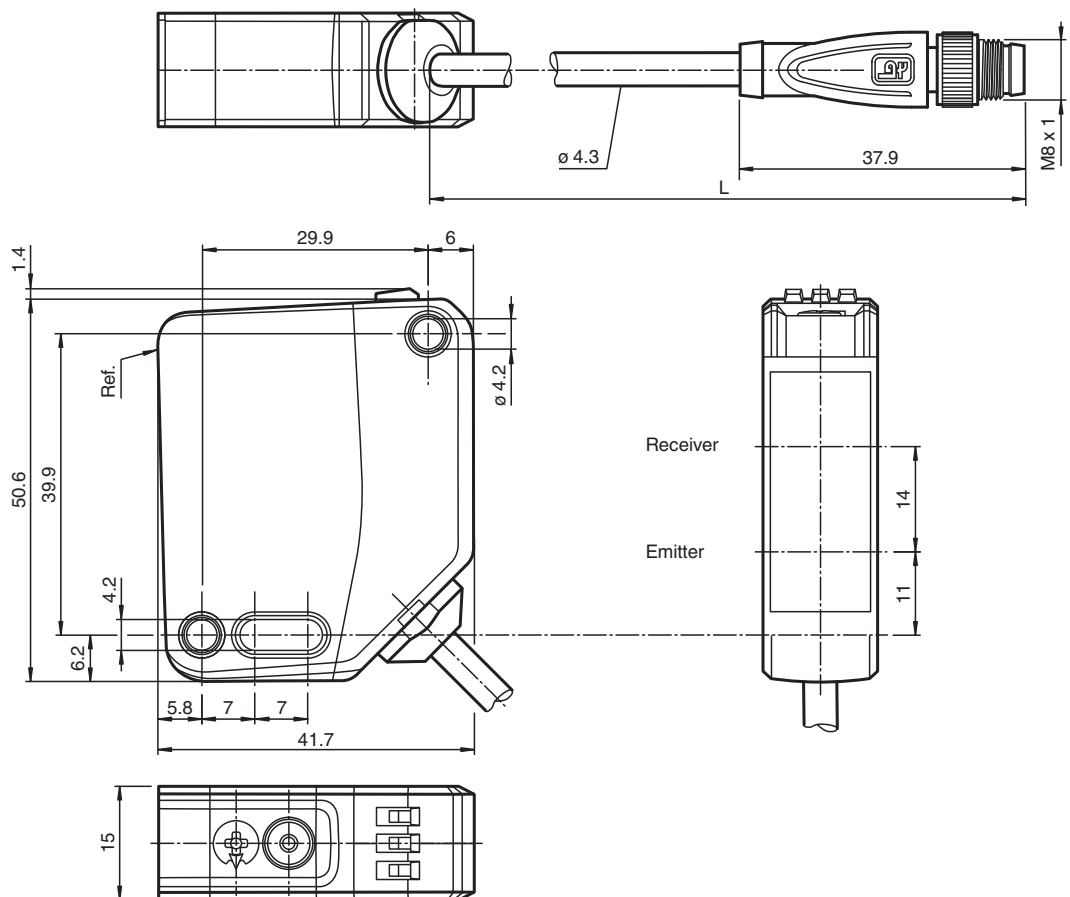

Release date: 2023-01-24 Date of issue: 2023-01-24 Filename: 295670-100312\_eng.pdf

Refer to "General Notes Relating to Pepperl+Fuchs Product Information".

Pepperl+Fuchs Group  
www.pepperl-fuchs.com

USA: +1 330 486 0001  
fa-info@us.pepperl-fuchs.com

Germany: +49 621 776 1111  
fa-info@de.pepperl-fuchs.com

Singapore: +65 6779 9091  
fa-info@sg.pepperl-fuchs.com

**PEPPERL+FUCHS**

## Technical Data

General specifications	
Measurement range	100 ... 300 mm
Reference target	standard white, 100 mm x 100 mm
Light source	laser diode
Light type	modulated visible red light
Laser nominal ratings	
Note	LASER LIGHT , DO NOT STARE INTO BEAM
Laser class	1
Wave length	680 nm
Beam divergence	> 5 mrad, d63 < 2,8 mm in the range of 350 mm ... 800 mm
Pulse length	5.5 µs
Repetition rate	approx. 2.4 kHz
max. pulse energy	< 40 nJ
Angle deviation	max. +/- 1.5 °
Diameter of the light spot	approx. 3 mm at a distance of 300 mm
Opening angle	approx. 0.3 °
Ambient light limit	EN 60947-5-2 : 45000 Lux
Resolution	0.1 mm
Functional safety related parameters	
MTTF <sub>d</sub>	560 a
Mission Time (T <sub>M</sub> )	20 a
Diagnostic Coverage (DC)	0 %
Indicators/operating means	
Operation indicator	LED green: constantly on - power on flashing (4Hz) - short circuit flashing with short break (1 Hz) - IO-Link mode
Function indicator	LED yellow: constantly on - switch output active constantly off - switch output inactive
Control elements	Teach-In key
Control elements	5-step rotary switch for operating modes selection
Electrical specifications	
Operating voltage	U <sub>B</sub> 10 ... 30 V DC
Ripple	max. 10 %
No-load supply current	I <sub>0</sub> < 16 mA at 24 V supply voltage
Protection class	III
Interface	
Interface type	IO-Link ( via C/Q = pin 4 )
IO-Link revision	1.1
Device profile	Identification and diagnosis Smart Sensor type 0/type 3.3
Device ID	0x11190A (1120522)
Transfer rate	COM2 (38.4 kBit/s)
Min. cycle time	3 ms
Process data width	Process data input 4 byte Process data output 2 bits
SIO mode support	yes
Compatible master port type	A
Output	
Switching type	The default setting is: C/Q - Pin4: NPN normally open, PNP normally closed, IO-Link
Signal output	1 push-pull (4 in 1) output, short-circuit protected, reverse polarity protected, overvoltage protected
Switching voltage	max. 30 V DC
Switching current	max. 100 mA , resistive load

Release date: 2023-01-24 Date of issue: 2023-01-24 Filename: 295670-100312\_eng.pdf

## Technical Data

Usage category	DC-12 and DC-13	
Voltage drop	$U_d$	$\leq 1.5$ V DC
Response time	2 ms	
<b>Conformity</b>		
Communication interface	IEC 61131-9	
Product standard	EN 60947-5-2	
Laser safety	EN 60825-1:2014	
<b>Measurement accuracy</b>		
Temperature drift	0.05 %/K	
Warm up time	5 min	
Repeat accuracy	< 0.5 %	
Linearity error	0.5 %	
<b>Approvals and certificates</b>		
UL approval	E87056 , cULus Listed , class 2 power supply , type rating 1	
CCC approval	CCC approval / marking not required for products rated $\leq 36$ V	
FDA approval	IEC 60825-1:2014 Complies with 21 CFR 1040.10 and 1040.11 except for deviations pursuant to Laser Notice No. 50, dated June 24, 2007	
<b>Ambient conditions</b>		
Ambient temperature	10 ... 60 °C (50 ... 140 °F)	
Storage temperature	-40 ... 70 °C (-40 ... 158 °F)	
<b>Mechanical specifications</b>		
Housing width	15 mm	
Housing height	50.6 mm	
Housing depth	41.7 mm	
Degree of protection	IP67 / IP69 / IP69K	
Connection	300 mm fixed cable with M8 x 1, 3-pin connector	
Material		
Housing	PC (Polycarbonate)	
Optical face	PMMA	
Mass	approx. 41 g	
Cable length	0.3 m	

## Connection

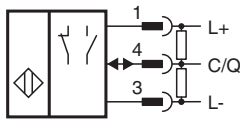

## Connection Assignment



## Connection Assignment

Wire colors in accordance with EN 60947-5-2

1	BN	(brown)
3	BU	(blue)
4	BK	(black)

## Assembly

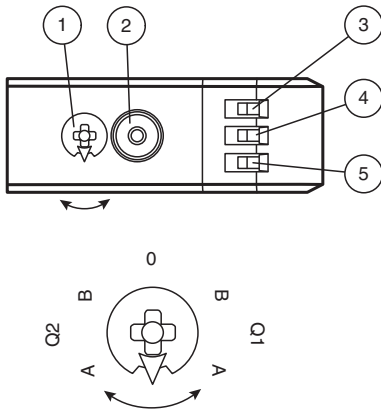





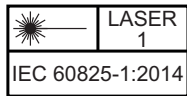



1	Mode rotary switch	
2	Teach-in button	
3	Switching output display Q2	YE
4	Switching output display Q1	YE
5	Operating indicator	GN

Q1B	Switching output 1/switch point B
Q1A	Switching output 1/switch point A
Q2A	Switching output 2/switch point A
Q2B	Switching output 2/switch point B
0	Keylock









## Accessories

	<b>V3-GM-2M-PUR</b>	Female cordset single-ended M8 straight A-coded, 3-pin, PUR cable grey
	<b>OMH-MLV12-HWK</b>	Mounting bracket for series MLV12 sensors
	<b>OMH-R200-01</b>	Mounting aid for round steel $\varnothing$ 12 mm or sheet 1.5 mm ... 3 mm
	<b>OMH-R20x-Quick-Mount</b>	Quick mounting accessory
	<b>OMH-MLV12-HWG</b>	Mounting bracket for series MLV12 sensors
	<b>V3-WM-2M-PUR</b>	Female cordset single-ended M8 angled A-coded, 3-pin, PUR cable grey
	<b>ICE2-8IOL-G65L-V1D</b>	EtherNet/IP IO-Link master with 8 inputs/outputs
	<b>ICE3-8IOL-G65L-V1D</b>	PROFINET IO IO-Link master with 8 inputs/outputs

Release date: 2023-01-24 Date of issue: 2023-01-24 Filename: 295670-100312\_eng.pdf

Refer to "General Notes Relating to Pepperl+Fuchs Product Information".

## Accessories

	<b>ICE2-8IOL-K45S-RJ45</b>	EtherNet/IP IO-Link master with 8 inputs/outputs, DIN rail, screw terminal
	<b>ICE3-8IOL-K45P-RJ45</b>	PROFINET IO IO-Link master with 8 inputs/outputs, DIN rail, push-in terminals
	<b>ICE3-8IOL-K45S-RJ45</b>	PROFINET IO IO-Link master with 8 inputs/outputs, DIN rail, screw terminal
	<b>IO-Link-Master02-USB</b>	IO-Link master, supply via USB port or separate power supply, LED indicators, M12 plug for sensor connection
	<b>ICE1-8IOL-G30L-V1D</b>	Ethernet IO-Link module with 8 inputs/outputs
	<b>ICE1-8IOL-G60L-V1D</b>	Ethernet IO-Link module with 8 inputs/outputs
	<b>ICE2-8IOL-K45P-RJ45</b>	EtherNet/IP IO-Link master with 8 inputs/outputs, DIN rail, push-in connectors

## Commissioning

### Teach-In (TI)

Use the rotary switch for switching signal **Q1** or **Q2** to select the relevant switching threshold A and/or B to teach in.

- The yellow LEDs indicate the current state of the selected output.

To teach in a switching threshold, press and hold the "TI" button for approximately 1 s, until the yellow and green LEDs flash in phase. Teach-in starts when the "TI" button is released.

- Teach-in successful: the yellow and green LEDs flash alternately at 2.5 Hz.
- Teach-in unsuccessful: the yellow and green LEDs quickly flash alternately at 8 Hz.

After an unsuccessful Teach-in, the sensor continues to operate with the previous valid setting after the relevant visual fault signal is issued.

Set switching mode: you can define different switching modes by teaching in the relevant distance data for switching thresholds A and B.

#### 1. Single point mode:

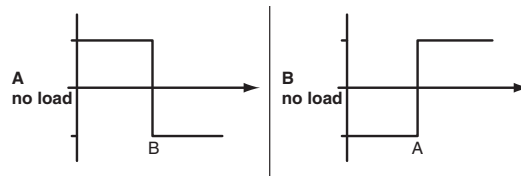

#### 2. Window mode:

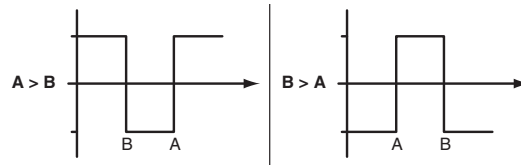

Teach in switching thresholds: you can teach in or overwrite a taught-in switching threshold at any time. To do this, press the "TI" button again.

Reset a value: you can reset a taught-in value. To do this, press the "TI" button for > 4 s, until the yellow and green LEDs go out. The reset process itself starts when the "TI" button is released.

- Reset successful: the yellow and green LEDs flash alternately at 2.5 Hz.

### Resetting to Factory Settings

To revert back to factory settings, press the "TI" button for > 10 s with the rotary switch set to position "O," until the yellow and green LEDs go out at the same time. The reset process itself starts when the "TI" button is released.

- Reset to factory settings successful: the yellow and green LEDs light up at the same time. The sensor then continues to operate with factory settings.

### OMT

- Factory setting for switching signal Q1:  
Switching signal is high active, window mode
- Factory setting for switching signal Q2:  
Switching signal is high active, window mode

## Configuration

### Setting different operating modes via the IO-Link interface

The devices are equipped with an IO-Link interface as standard for diagnostics and parameterization tasks to ensure optimum adjustment of the sensors to the relevant application.

#### Single point mode operating mode (one switch point):

- "Detection of objects irrespective of type and color in a defined detection range. Objects in the background are suppressed.
- "The switch point corresponds exactly to the set point.



**Window mode operating mode (two switch points):**

- Detection of objects irrespective of type and color in a defined detection range. Reliable detection when object leaves the detection range.
- Window mode with two switch points.



**Center window mode operating mode (one switch point):**

- Detection of objects irrespective of type and color in a defined detection range. Sets a defined window around a given object. Objects outside this window are not detected.
- Window mode with one switch point.



**Two point mode operating mode (hysteresis operating mode):**

- Detection of objects irrespective of type and color between a defined switch-on and switch-off point.

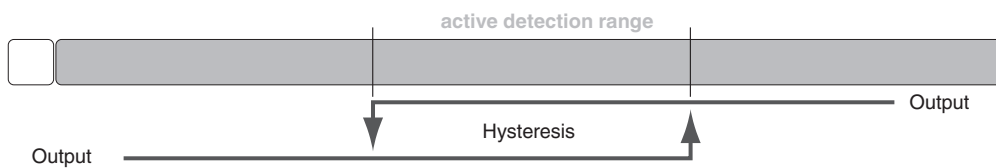

Inactive operating mode:

- Evaluation of switching signals is deactivated.

The associated IODD device description file can be found in the download area at [www.pepperl-fuchs.com](http://www.pepperl-fuchs.com).