

Retroreflective sensor

MLV12-54-G/32/82g/124



- Series of sensors in a widely used standard housing
- Reliable recognition of reflective objects and clear glass
- TEACH-IN switch for setting the contrast detection levels
- Automatic adjustment in case of soiling in contrast detection mode
- High level of stability thanks to the metal housing frame
- Resistant against noise: reliable operation under all conditions

Retroreflective sensor for glass detection, small design, 5.6 m detection range, red light, light/dark on, PNP output, weak signal output, external Teach-In, M12 plug



Dimensions

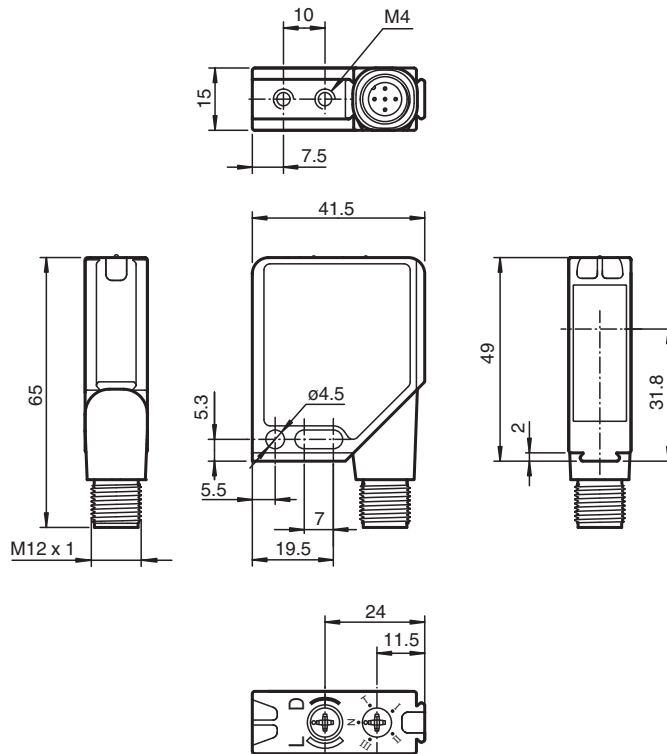

Release date: 2023-04-04 Date of issue: 2023-04-04 Filename: 115798_eng.pdf

Refer to "General Notes Relating to Pepperl+Fuchs Product Information".

Pepperl+Fuchs Group
www.pepperl-fuchs.com

USA: +1 330 486 0001
fa-info@us.pepperl-fuchs.com

Germany: +49 621 776 1111
fa-info@de.pepperl-fuchs.com

Singapore: +65 6779 9091
fa-info@sg.pepperl-fuchs.com

PF PEPPERL+FUCHS

Technical Data

General specifications		
Effective detection range		0 ... 4.2 m
Reflector distance		0 ... 4.2 m
Threshold detection range		5.6 m
Reference target		H85-2 reflector
Light source		LED
Light type		modulated visible red light , 660 nm
Polarization filter		yes
Diameter of the light spot		approx. 110 mm at detection range 4.2 m
Opening angle		1.5 °
Ambient light limit		
Continuous light		40000 Lux
Modulated light		5000 Lux
Functional safety related parameters		
MTTF _d		1000 a
Mission Time (T _M)		20 a
Diagnostic Coverage (DC)		0 %
Indicators/operating means		
Operation indicator		LED green, flashes in case of short-circuit
Function indicator		2 LEDs yellow for switching state, stability control, TEACH-IN and contrast detection mode
Control elements		rotary switch for light/dark, 5-step switch for contrast recognition adjustment
Contrast detection levels		10 % - clean, water filled PET bottles 18 % - clear glass bottles 40 % - colored glass or opaque materials adjustable by Teach-In key or external wire
Electrical specifications		
Operating voltage	U _B	10 ... 30 V DC
Ripple		max. 10 %
No-load supply current	I ₀	max. 55 mA
Input		
Function input		Ext. Teach-In input (ET)
Output		
Stability alarm output		1 PNP function reserve output (alarm), short-circuit protected, protected from reverse polarity, open collector
Switching type		light/dark on switchable
Signal output		1 PNP output, short-circuit protected, reverse polarity protected, open collector
Switching voltage		max. 30 V DC
Switching current		max. 0.2 A
Voltage drop	U _d	≤ 2.5 V DC
Switching frequency	f	1000 Hz
Response time		0.5 ms
Conformity		
Product standard		EN 60947-5-2
Compliance with standards and directives		
Standard conformity		
Shock and impact resistance		IEC / EN 60068. half-sine, 40 g in each X, Y and Z directions
Vibration resistance		IEC / EN 60068-2-6. Sinus. 10 -150 Hz, 5 g in each X, Y and Z directions
Approvals and certificates		
Protection class		II, rated voltage ≤ 300 V AC with pollution degree 1-2 according to IEC 60664-1
UL approval		cULus
CCC approval		CCC approval / marking not required for products rated ≤36 V
Ambient conditions		
Ambient temperature		-40 ... 60 °C (-40 ... 140 °F)

Release date: 2023-04-04 Date of issue: 2023-04-04 Filename: 115798_eng.pdf

Refer to "General Notes Relating to Pepperl+Fuchs Product Information".

Pepperl+Fuchs Group
www.pepperl-fuchs.comUSA: +1 330 486 0001
fa-info@us.pepperl-fuchs.comGermany: +49 621 776 1111
fa-info@de.pepperl-fuchs.comSingapore: +65 6779 9091
fa-info@sg.pepperl-fuchs.com

PEPPERL+FUCHS

Technical Data

Storage temperature	-40 ... 75 °C (-40 ... 167 °F)
Mechanical specifications	
Housing width	41.5 mm
Housing height	49 mm
Housing depth	15 mm
Degree of protection	IP67
Connection	Metal connector, M12, 5-pin, 90° rotatable
Material	
Housing	Frame: nickel plated, die cast zinc, Laterals: glass-fiber reinforced plastic PC
Optical face	Plastic pane
Mass	60 g

Connection Assignment

Option:

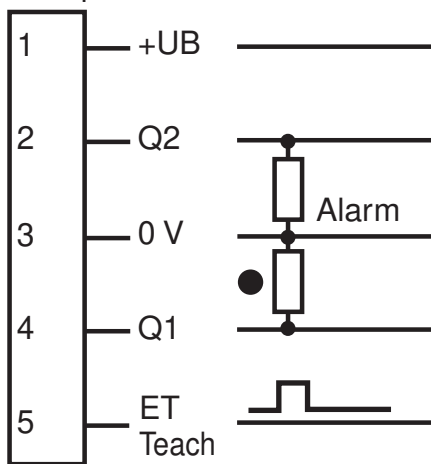

- = Light on
- = Dark on

Connection Assignment

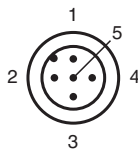

Wire colors in accordance with EN 60947-5-2

1	BN	(brown)
2	WH	(white)
3	BU	(blue)
4	BK	(black)
5	GY	(gray)

Assembly

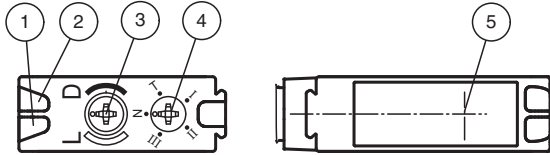

1	Operating display	green
2	Switch state	yellow
3	Bright/dark switch	
4	Teach-In switch	
5	Optical axis	

Characteristic Curve

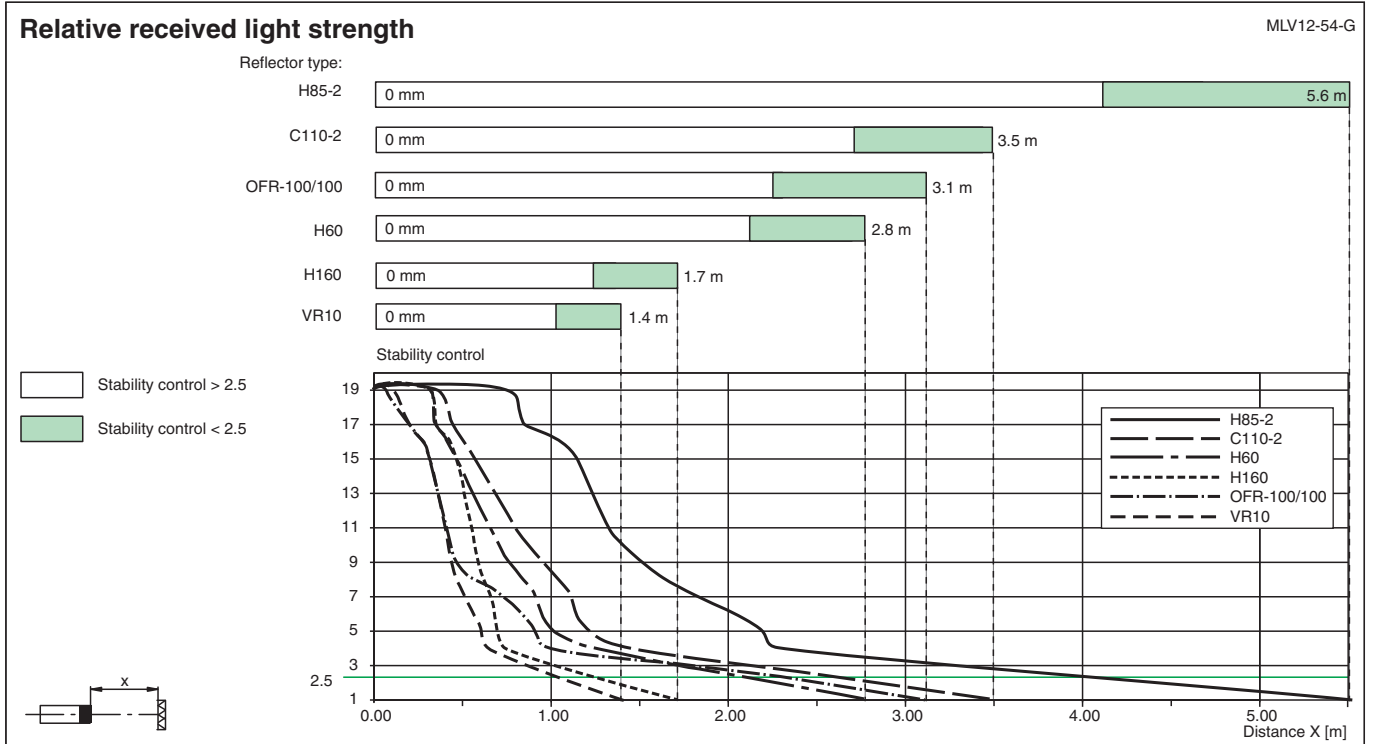
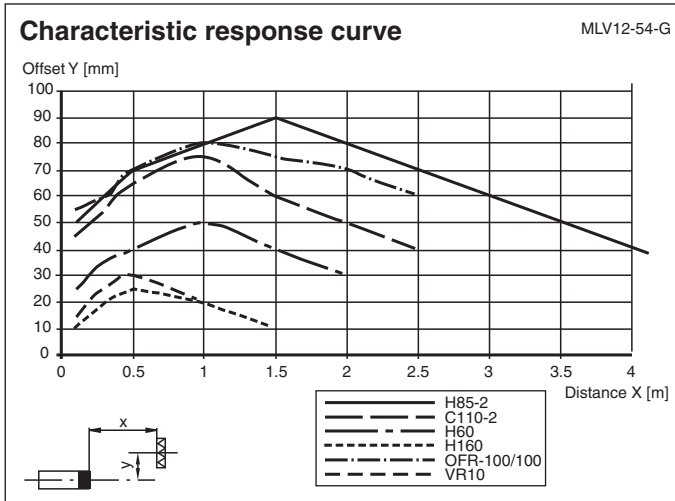







Accessories

	OMH-MLV12-HWG	Mounting bracket for series MLV12 sensors
--	----------------------	---

Release date: 2023-04-04 Date of issue: 2023-04-04 Filename: 115798_eng.pdf

Accessories

	OMH-MLV12-HWK	Mounting bracket for series MLV12 sensors
	OMH-K01	dove tail mounting clamp
	OMH-K02	dove tail mounting clamp
	OMH-K03	dove tail mounting clamp
	OMH-06	Mounting aid for round steel ø 12 mm or sheet 1.5 mm ... 3 mm
	ORR50G	Reflector, rectangular 50.9 mm x 60.9 mm, mounting holes, fixing strap and polarization filter

Teach-In

Switch position "N" (normal operation):

Yellow LEDs light if the light beam is free, flash if the functional reserve is used, turn off if the light beam is interrupted.

Switch position "T" (TEACH-IN operation):

Yellow LED flashes slowly after 1 second (about 1.5 Hz).

The sensor is now ready to be set to a particular contrast detection value using the mechanical switch (position I, II, or III) or an external signal.

Switch positions "I", "II", and "III" (contrast detection operation):

Contrast detection values: I for 10 %, II for 18 %, III for 40 %.

1. Yellow LED lights continually: light path free
2. Yellow LED off: object detected
3. Yellow LED flashes quickly: unsure detection, too much contamination, functional reserve too low.

A direct switching of the contrast detection levels is possible without having to put the switch back into position "T" first.

External teach input (ET):

In switch position "T", you can apply a pulse over a control line to plug pin 5 to select the corresponding contrast detection.

The desired contrast detection is set by applying a high pulse of a particular width:

- I: 50 ms (30 ms ... 100 ms)
- II: 150 ms (100 ms ... 200 ms)
- III: > 200 ms

Pre-fault output (optional):

Switch position "N":

Inactive if the functional reserve is used after approx. 5 sec. Immediately inactive if 4 light beam interruptions occur within the flashing time.

Contrast detection levels:

The output goes inactive if the contamination no longer permits readjustment; the yellow LED flashes quickly. In the case of additional contamination, the detection of low contrast is no longer guaranteed.

Warm-up period:

Any warm-up period can be shortened by repeating the learn (teach) process.

