

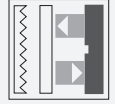

Retroreflective sensor RL28-55-V/49/82b/105



- Foreground suppression, suited to recording of sheet-shrink-wrapped objects
- Ultra bright LEDs for power on, weak signal indication and switching state
- Not sensitive to ambient light, even with switched energy saving lamps
- Waterproof, degree of protection IP67
- Protection class II

Retroreflective sensor with polarization filter with foreground suppression



Dimensions

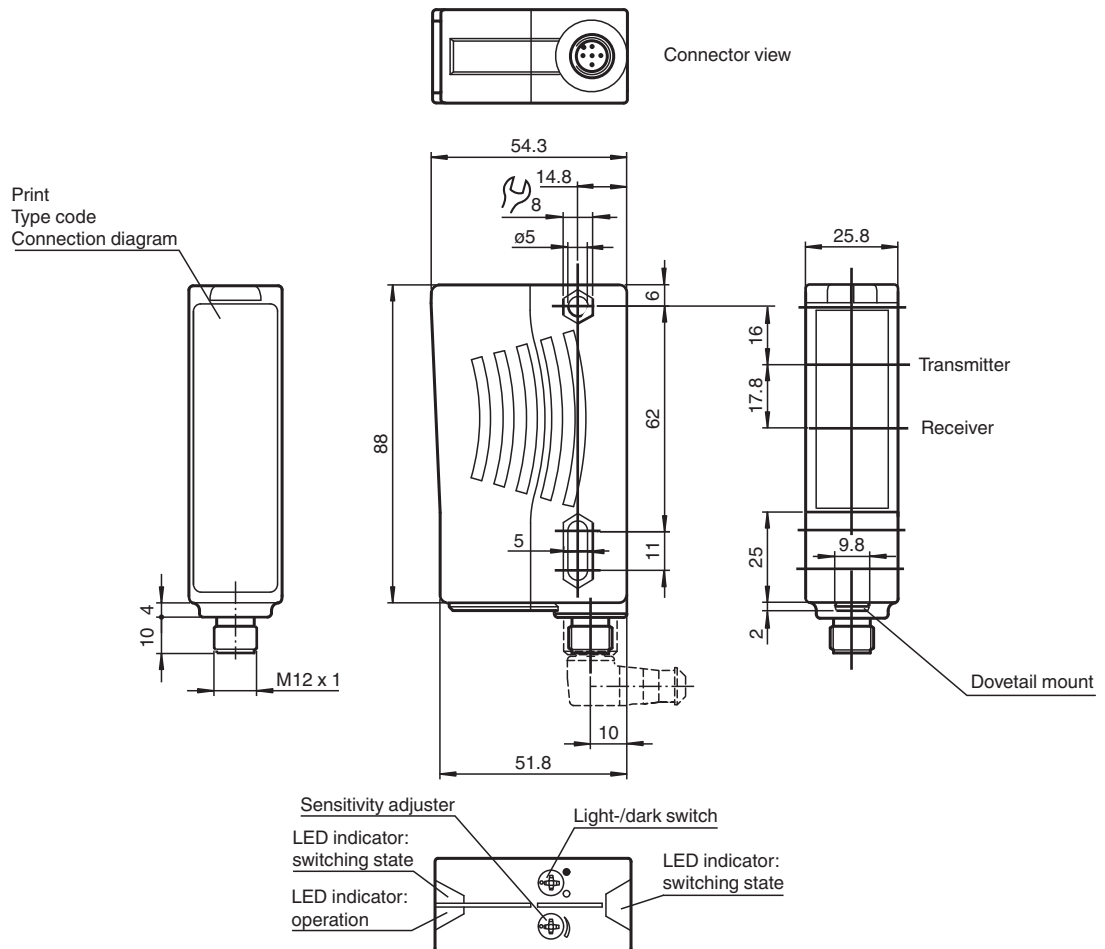

Release date: 2023-03-28 Date of issue: 2023-03-28 Filename: 421149_eng.pdf

Refer to "General Notes Relating to Pepperl+Fuchs Product Information".

Pepperl+Fuchs Group
www.pepperl-fuchs.com

USA: +1 330 486 0001
fa-info@us.pepperl-fuchs.com

Germany: +49 621 776 1111
fa-info@de.pepperl-fuchs.com

Singapore: +65 6779 9091
fa-info@sg.pepperl-fuchs.com

PF PEPPERL+FUCHS

Technical Data

General specifications		
Effective detection range		0 ... 13 m
Reflector distance		0.5 ... 13 m (blind range 0 ... 0.2 m faded out)
Threshold detection range		17 m
Reference target		H85-2 reflector
Light source		LED
Light type		modulated visible red light , 660 nm
Polarization filter		yes
Diameter of the light spot		approx. 220 mm at a distance of 13 m
Opening angle		emitter 1.2° receiver 2°
Ambient light limit		80000 Lux
Functional safety related parameters		
MTTF _d		690 a
Mission Time (T _M)		20 a
Diagnostic Coverage (DC)		0 %
Indicators/operating means		
Operation indicator		LED green
Function indicator		2 LEDs yellow, light up when light beam is free, flash when falling short of the stability control, off when light beam is interrupted
Control elements		sensitivity adjustment (Adjustment to < 25% of the effective operating range) , Light-on/dark-on changeover switch
Electrical specifications		
Operating voltage	U _B	10 ... 30 V DC
Ripple		10 %
No-load supply current	I ₀	≤ 40 mA
Output		
Stability alarm output		1 PNP, inactive when falling short of the stability control for 10;s immediately inactive if 4 light beam interruptions take place
Switching type		light/dark on switchable
Signal output		1 NPN, 1 PNP synchronized-switching, short-circuit protected, reverse polarity protected , open collectors
Switching voltage		max. 30 V DC
Switching current		max. 200 mA
Switching frequency	f	1000 Hz
Response time		0.5 ms
Conformity		
Product standard		EN 60947-5-2
Approvals and certificates		
Protection class		II, rated voltage ≤ 250 V AC with pollution degree 1-2 according to IEC 60664-1
UL approval		E87056 , cULus Listed , class 2 power supply , type rating 1
Ambient conditions		
Ambient temperature		-40 ... 60 °C (-40 ... 140 °F)
Storage temperature		-40 ... 60 °C (-40 ... 140 °F)
Mechanical specifications		
Housing width		25.8 mm
Housing height		88 mm
Housing depth		54.3 mm
Degree of protection		IP67
Connection		5-pin, M12 x 1 connector
Material		
Housing		Plastic ABS
Optical face		plastic
Connector		plastic

Release date: 2023-03-28 Date of issue: 2023-03-28 Filename: 421149_eng.pdf

Technical Data

Mass

70 g

Connection Assignment

Option: /49

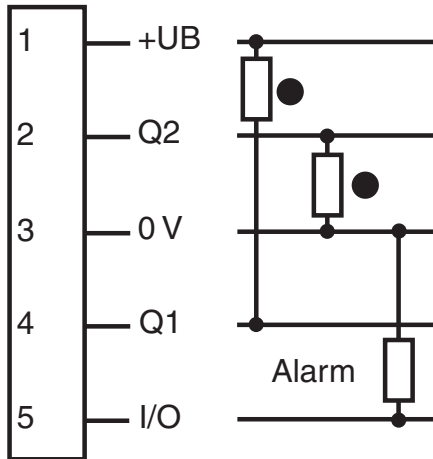

○ = Light on
● = Dark on

Connection Assignment

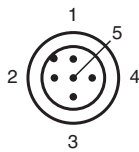

Wire colors in accordance with EN 60947-5-2

1	BN	(brown)
2	WH	(white)
3	BU	(blue)
4	BK	(black)
5	GY	(gray)

Characteristic Curve

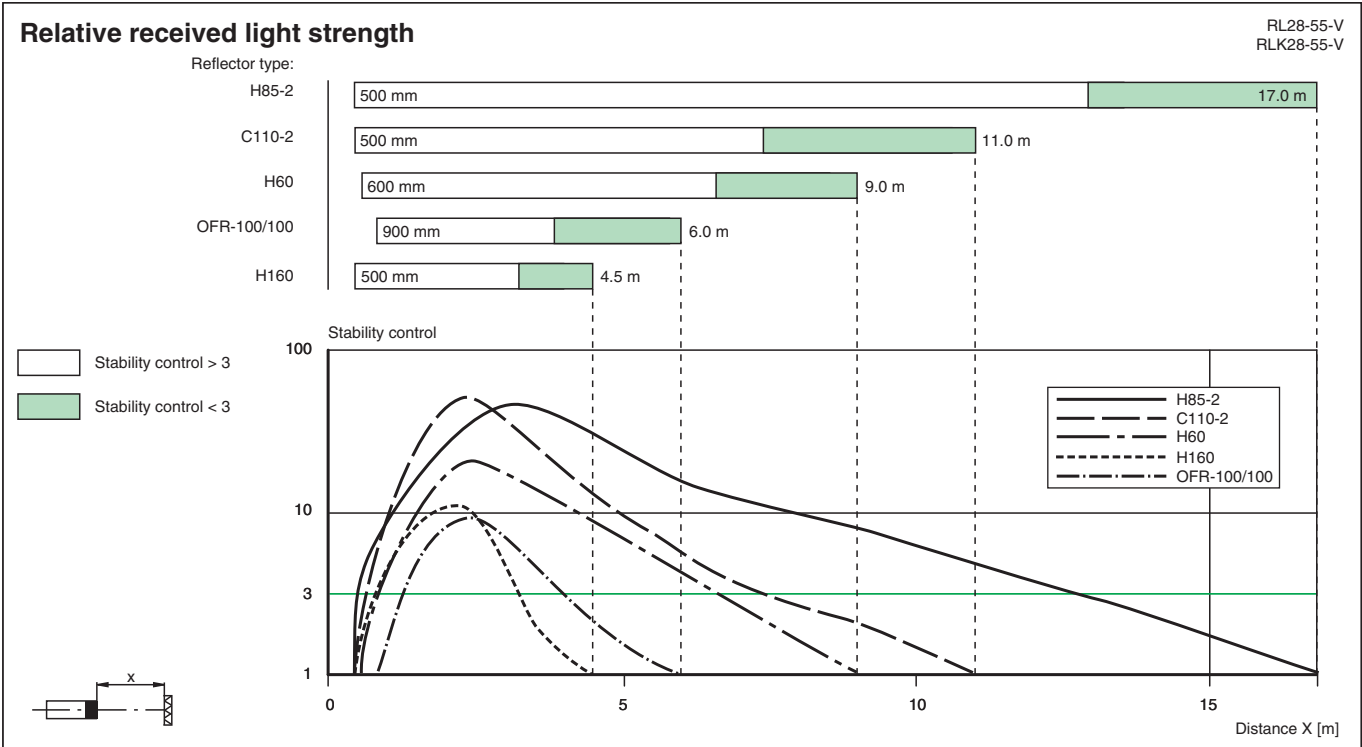
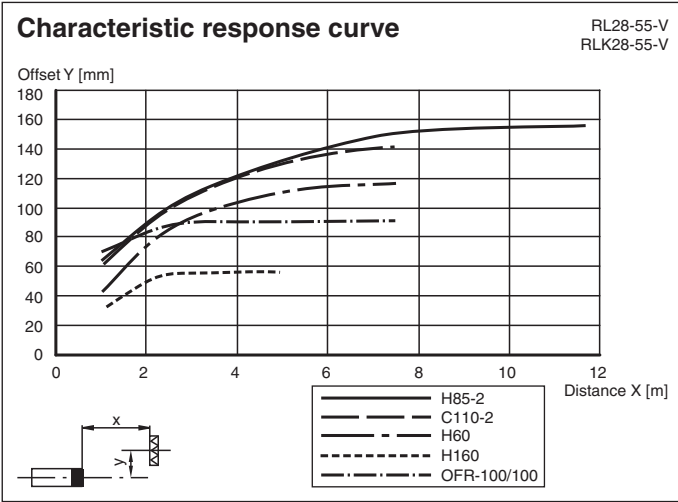





Application



Release date: 2023-03-28 Date of issue: 2023-03-28 Filename: 421149_eng.pdf

Refer to "General Notes Relating to Pepperl+Fuchs Product Information".

Accessories

	OMH-05	Mounting aid for round steel \varnothing 12 mm or sheet 1.5 mm ... 3 mm
	OMH-21	Mounting bracket: mounting aid for sensors in the RL* series
	OMH-22	Mounting aid for RL* series
	OMH-RLK29-HW	Mounting bracket for rear wall mounting
	OMH-RL28-C	Weld slag cover model