



Thru-beam sensor (pair)

OBE35M-R202-SE5



- Medium design with versatile mounting options
- Degree of protection IP67
- Mounting on full metal sockets
- Very bright, highly visible light spot
- Highly visible LEDs for Power ON and switching state
- Easy to use
- Image is generic for this device type and may deviate from the specific variant



Function

The optical sensors of this series for applications in standard automation have a modern housing design. The sensors are characterized by the many mounting options, easy handling and highly visible LED status indicators. The integrated full metal bushings ensure long-term secure and dimensionally stable mounting.

Dimensions

Drawing is generic for this device type and may deviate from the specific variant.
For the number of cores refer to connection diagram.

Dimensions

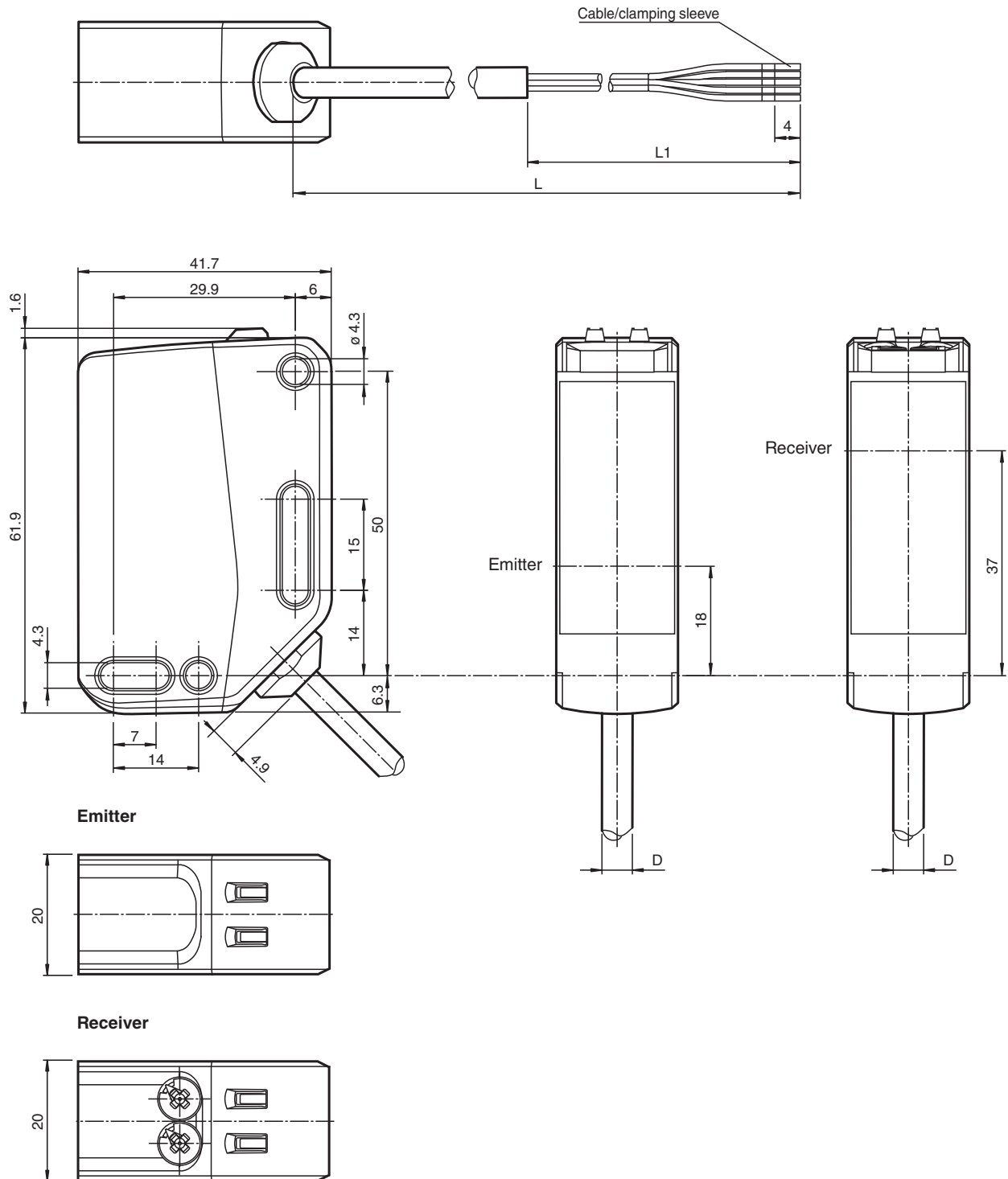

Release date: 2023-03-28 Date of issue: 2023-03-28 Filename: 70147120_eng.pdf

Technical Data

System components	
Emitter	OBE35M-R202-S
Receiver	OBE35M-R202-E5
General specifications	
Effective detection range	0 ... 35 m
Threshold detection range	47 m
Light source	LED
Light type	modulated visible red light

Refer to "General Notes Relating to Pepperl+Fuchs Product Information".

Technical Data

LED risk group labelling		exempt group
Transmitter frequency		F1 = 8.2 kHz
Diameter of the light spot		approx. 1200 mm at a distance of 35 m
Opening angle		2 °
Ambient light limit		EN 60947-5-2 : 40000 Lux
Functional safety related parameters		
MTTF _d		656 a
Mission Time (T _M)		20 a
Diagnostic Coverage (DC)		0 %
Indicators/operating means		
Operation indicator		LED green: on - power on flashing (4 Hz) - short circuit
Function indicator		Yellow LED: Permanently lit - light path clear Permanently off - object detected Flashing (4 Hz) - insufficient operating reserve Flashing (8 Hz) - fault detected, the outputs maintain the status
Control elements		Receiver: light/dark switch
Control elements		Receiver: sensitivity adjustment
Electrical specifications		
Operating voltage	U _B	10 ... 30 V DC
Ripple		max. 10 %
No-load supply current	I ₀	Emitter: ≤ 25 mA Receiver: ≤ 40 mA at 24 V Operating voltage
Protection class		III
Input		
Test input		emitter deactivation at +U _B
Output		
Switching type		The switching type of the sensor is adjustable. The default setting is: Q - BK: PNP normally open / dark-on
Signal output		1 PNP output, short-circuit protected, reverse polarity protected, open collector
Switching voltage		max. 30 V DC
Switching current		max. 100 mA , resistive load
Usage category		DC-12 and DC-13
Voltage drop	U _d	≤ 1.5 V DC
Switching frequency	f	1000 Hz
Response time		0.5 ms
Conformity		
Product standard		EN 60947-5-2
Approvals and certificates		
UL approval		E87056 , cULus Listed , class 2 power supply , type rating 1
CCC approval		CCC approval / marking not required for products rated ≤36 V
Ambient conditions		
Ambient temperature		-30 ... 60 °C (-22 ... 140 °F) , fixed cable -20 ... 60 °C (-4 ... 140 °F) , movable cable not appropriate for conveyor chains
Storage temperature		-40 ... 70 °C (-40 ... 158 °F)
Mechanical specifications		
Housing width		20 mm
Housing height		62 mm
Housing depth		42 mm
Degree of protection		IP67
Connection		2 m fixed cable
Material		
Housing		PC (Polycarbonate)
Optical face		PMMA

Release date: 2023-03-28 Date of issue: 2023-03-28 Filename: 70147120_eng.pdf

Refer to "General Notes Relating to Pepperl+Fuchs Product Information".

Pepperl+Fuchs Group
www.pepperl-fuchs.comUSA: +1 330 486 0001
fa-info@us.pepperl-fuchs.comGermany: +49 621 776 1111
fa-info@de.pepperl-fuchs.comSingapore: +65 6779 9091
fa-info@sg.pepperl-fuchs.com

PEPPERL+FUCHS

Technical Data

Mass	Emitter: approx. 95 g receiver: approx. 100 g	
Cable length		2 m

Connection

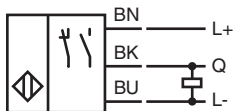
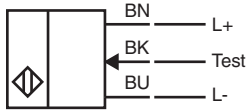

Indication

Emitter

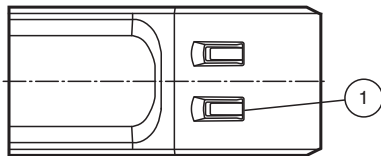

1	Operation indicator	GN
---	---------------------	----

Receiver

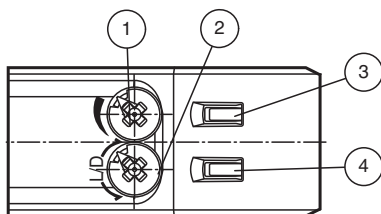

1	Sensitivity adjuster	
2	Light-on / dark-on changeover switch	
3	Signal indicator	YE
4	Operation indicator	GN

Characteristic Curve

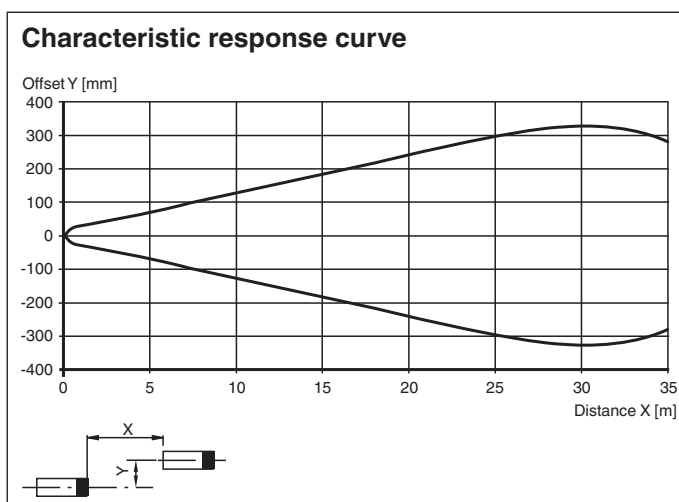

Release date: 2023-03-28 Date of issue: 2023-03-28 Filename: 70147120_eng.pdf

Characteristic Curve

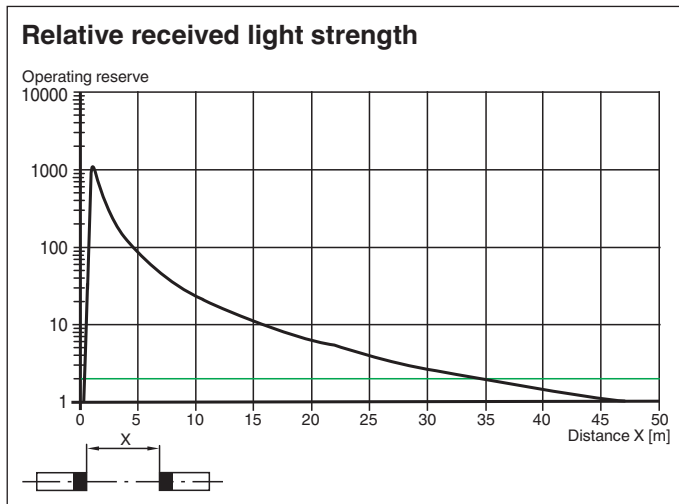

Commissioning

Sensing Range / Sensitivity

Turn sensing range / sensitivity adjuster clockwise to increase sensing range / sensitivity.
Turn sensing range / sensitivity adjuster counter clockwise to decrease sensing range / sensitivity.
The internal end stop signals the end of the adjustment range.

Light-on / Dark-on Configuration

To set light switching or dark switching, turn the light/dark changeover switch to the end stop:

- clockwise: dark switching
- counterclockwise: light switching

Accessories

	OMH-RL31-02	Mounting bracket narrow
-------------------------------------------------------------------------------------	--------------------	-------------------------