

# Connection cable, shielded

## V1-G-BK3M-PUR-O1S-V1-W



- Suitable for outdoor use (UV- and ozone resistant)
- Suitable for drag chains and abrasion resistant
- Degree of protection IP68 / IP69
- Free of paint wetting interfering substances
- Resistant to microbes and hydrolysis
- Oil resistant
- Resistant to salt water
- UL listed for USA and Canada
- Halogen-free
- Shield connected to screw connection
- Specific design protects against loosening and inaccurate installation

Cordset M12 socket straight to M12 plug angled A-coded, 4-pin, PUR cable black, shielded, UL approved, drag chain suitable, outdoor



### Dimensions

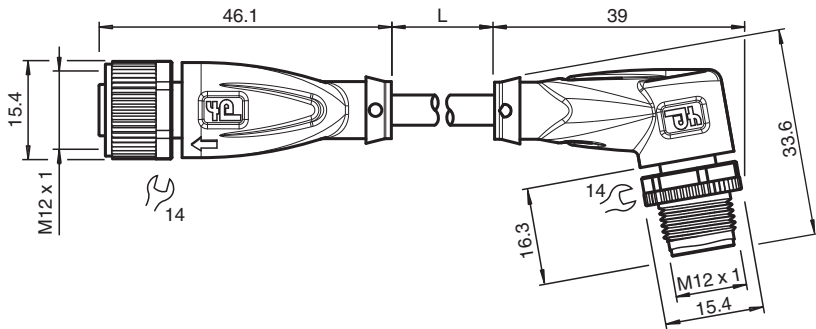

### Technical Data

General specifications			
Connector 1			
Connection			socket
Construction type			M12
Style			straight
Locking			screw connection
Number of pins			4
Coding			A-coded
Connector 2			
Connection			plug
Construction type			M12
Style			angled
Locking			screw connection
Number of pins			4
Coding			A-coded
Electrical specifications			
Operating voltage	U <sub>B</sub>		max. 48 V AC / 60 V DC
Operating current	I <sub>B</sub>		max. 4 A

Release date: 2023-07-13 Date of issue: 2023-07-13 Filename: 240790-100011\_eng.pdf

Refer to "General Notes Relating to Pepperl+Fuchs Product Information".

Pepperl+Fuchs Group  
www.pepperl-fuchs.com

USA: +1 330 486 0001  
fa-info@us.pepperl-fuchs.com

Germany: +49 621 776 1111  
fa-info@de.pepperl-fuchs.com

Singapore: +65 6779 9091  
fa-info@sg.pepperl-fuchs.com

**PEPPERL+FUCHS**

## Technical Data

Conformity		
Degree of protection		EN 60529
Plug connection		connector M12 x 1 : IEC 61076-2-101
Flammability		UL 1581; DIN EN 60332-2-2
Halogen-free		DIN VDE 0472-815 / DIN EN 50267-2-1
Oil resistance		DIN EN 60811-2-1
Approvals and certificates		
UL approval		AWM STYLE 21924/11558 105°C 300V AWM I A/B 105°C 300V FT2 (cable)
UL File Number		E231213
Ambient conditions		
Ambient temperature		
Plug connector		-40 ... 90 °C (-40 ... 194 °F)
Cable, fixed		-50 ... 105 °C (-58 ... 221 °F)
Cable, flexing		-30 ... 105 °C (-22 ... 221 °F)
Pollution degree		3
Mechanical specifications		
Plug connector		
Tightening torque		0.6 Nm
Loosening protection		available
Tool installation		straight knurling and hexagon nut SW = 14 mm
Mating cycles		min. 100
Shielding		shield connected to screw connection
Degree of protection		IP68 / IP69
Cable		according to IEC/EN 60228 (DIN VDE 0295) class 6
Sheath diameter		6 mm
Bending radius		> 10 x cable diameter, moving > 5 x cable diameter, fixed
Sheath stripping force		max. 80 N / 300 mm
Sheath color		black (similar to RAL 7021)
Number of cores		4
Core cross section		0.5 mm <sup>2</sup>
Cores color		Core 1: brown Core 2: white Core 3: blue Core 4: black
Core construction		28 x 0.15 mm Ø
Shield		tinned copper braiding, 85 % coverage
Length	L	3 m
Cable code		Li 9Y C11Y 4 x 0,50
Drag chain suitability		
Drag chain cycles		min. 2000000
Motion velocity		max. 3 m/s
Traverse distance		max. 10 m
Acceleration		max. 10 m/s <sup>2</sup>
Material		
PWIS free		yes
Halogen-free		yes
Plug connector		
Screw connection		Zinc diecast, nickel-plated
Body		TPU, black
Seal		FKM
Contact surface		gold plated (Au)
Flammability		V-2
Cable		

Release date: 2023-07-13 Date of issue: 2023-07-13 Filename: 240790-100011\_eng.pdf

Refer to "General Notes Relating to Pepperl+Fuchs Product Information".

Pepperl+Fuchs Group  
www.pepperl-fuchs.comUSA: +1 330 486 0001  
fa-info@us.pepperl-fuchs.comGermany: +49 621 776 1111  
fa-info@de.pepperl-fuchs.comSingapore: +65 6779 9091  
fa-info@sg.pepperl-fuchs.com

**PEPPERL+FUCHS**





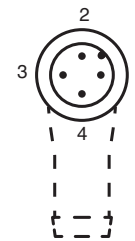
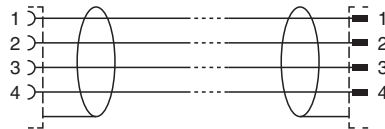
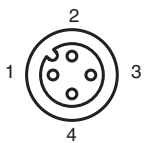

### Technical Data

Sheathing	PUR based on polyether
Core insulation	PP
Salt water resistance	yes
UV resistance	yes
Chemical resistance	good
Oil resistance	yes
Cooling lubricant resistance	yes
Microbial resistance	yes
Hydrolysis resistance	yes
Flammability	FT2

### Connection



### Accessories

	<b>MH V1-SCREWDRIVER</b>	Torque screwdriver (0.6 Nm)
	<b>MH V1-BIT M12</b>	plug-in cap M12
	<b>V1/V3-LABELHOLDER</b>	Label holder
	<b>V1/V3-LABEL</b>	Label plate
	<b>MH V1-Holder</b>	Modular universal holder for M12 connectors
	<b>V1-CLIP</b>	Unlocking protector for M12 connector
	<b>V1-MARKING-RING-COLOR</b>	Marking rings for M12 connectors, various colors

Release date: 2023-07-13 Date of issue: 2023-07-13 Filename: 240790-100011\_eng.pdf