

# Female cordset

## V1-W-BK30M-PUR-U



- Suitable for drag chains and abrasion resistant
- Suitable for robotic applications / torsion resistant
- Degree of protection IP68 / IP69
- Free of paint wetting interfering substances
- Resistant to microbes and hydrolysis
- UV resistant
- UL listed for USA and Canada
- Halogen-free
- Specific design protects against loosening and inaccurate installation

Female cordset single-ended M12 angled A-coded, 4-pin, PUR cable black, UL approved, drag chain suitable, torsion resistant



### Dimensions

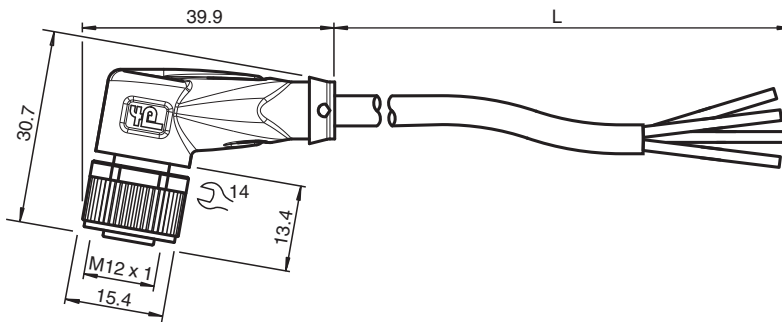

### Technical Data

| General specifications     |       |  |
|----------------------------|-------|--|
| Connector 1                |       |  |
| Connection                 |       | socket   |
| Construction type          |       | M12  |
| Style                      |       | angled   |
| Locking                    |       | screw connection                                   |
| Number of pins             |       | 4  |
| Coding                     |       | A-coded  |
| Connector 2                |       |  |
| Connection                 |       | cable end  |
| Electrical specifications  |       |  |
| Operating voltage          | $U_B$ | max. 250 V AC/DC                                   |
| Operating current          | $I_B$ | max. 4 A   |
| Conformity                 |       |  |
| Degree of protection       |       | EN 60529   |
| Plug connection            |       | connector M12 x 1 : IEC 61076-2-101                |
| Flammability               |       | UL 1581; DIN EN 60332-2-2                          |
| Halogen-free               |       | IEC 60754-1  |
| Approvals and certificates |       |  |
| UL approval                |       | AWM STYLE 20549 AWM I/II A/B 80°C 300V FT2 (cable) |

Release date: 2023-08-23 Date of issue: 2023-08-23 Filename: 239999-100007\_eng.pdf

Refer to "General Notes Relating to Pepperl+Fuchs Product Information".

Pepperl+Fuchs Group  
www.pepperl-fuchs.com

USA: +1 330 486 0001  
fa-info@us.pepperl-fuchs.com

Germany: +49 621 776 1111  
fa-info@de.pepperl-fuchs.com

Singapore: +65 6779 9091  
fa-info@sg.pepperl-fuchs.com

PEPPERL+FUCHS

## Technical Data

|                                  |   |   |
|----------------------------------|---|---|
| UL File Number                   |   | E231213   |
| <b>Ambient conditions</b>        |   |   |
| Ambient temperature              |   |   |
| Plug connector                   |   | -40 ... 90 °C (-40 ... 194 °F)                                  |
| Cable, fixed                     |   | -40 ... 80 °C (-40 ... 176 °F)                                  |
| Cable, flexing                   |   | -20 ... 80 °C (-4 ... 176 °F)                                   |
| Pollution degree                 |   | 3   |
| <b>Mechanical specifications</b> |   |   |
| Plug connector                   |   |   |
| Tightening torque                |   | 0.6 Nm  |
| Loosening protection             |   | available   |
| Tool installation                |   | straight knurling and hexagon nut SW = 14 mm                    |
| Mating cycles                    |   | min. 100  |
| Degree of protection             |   | IP68 / IP69   |
| Cable                            |   | according to IEC/EN 60228 (DIN VDE 0295) class 6                |
| Sheath diameter                  |   | 4.3 mm  |
| Bending radius                   |   | > 10 x cable diameter, moving<br>> 5 x cable diameter, fixed    |
| Sheath stripping force           |   | max. 80 N / 300 mm  |
| Sheath color                     |   | black (similar to RAL 9005)                                     |
| Number of cores                  |   | 4   |
| Core cross section               |   | 0.34 mm <sup>2</sup>  |
| Cores color                      |   | Core 1: brown<br>Core 2: white<br>Core 3: blue<br>Core 4: black |
| Core construction                |   | 42 x 0.1 mm Ø   |
| Length                           | L | 30 m  |
| Cable code                       |   | Li 9Y 11Y 4 x 0.34  |
| Drag chain suitability           |   |   |
| Drag chain cycles                |   | min. 5000000  |
| Motion velocity                  |   | max. 3.3 m/s  |
| Traverse distance                |   | max. 5 m  |
| Acceleration                     |   | max. 5 m/s <sup>2</sup>   |
| Torsion cycles                   |   | min. 1000000  |
| Torsional stress                 |   | ± 180 °/m   |
| <b>Material</b>                  |   |   |
| PWIS free                        |   | yes   |
| Halogen-free                     |   | yes   |
| Plug connector                   |   |   |
| Screw connection                 |   | Zinc diecast, nickel-plated                                     |
| Body                             |   | TPU, black  |
| Seal                             |   | FKM   |
| Contact surface                  |   | gold plated (Au)  |
| Flammability                     |   | V-2   |
| Cable                            |   |   |
| Sheathing                        |   | PUR based on polyether  |
| Core insulation                  |   | PP  |
| UV resistance                    |   | yes   |
| Chemical resistance              |   | good  |
| Oil resistance                   |   | yes   |
| Cooling lubricant resistance     |   | yes   |
| Microbial resistance             |   | yes   |
| Hydrolysis resistance            |   | yes   |

Release date: 2023-08-23 Date of issue: 2023-08-23 Filename: 239999-100007\_eng.pdf

Refer to "General Notes Relating to Pepperl+Fuchs Product Information".

Pepperl+Fuchs Group  
www.pepperl-fuchs.com

USA: +1 330 486 0001  
fa-info@us.pepperl-fuchs.com

Germany: +49 621 776 1111  
fa-info@de.pepperl-fuchs.com

Singapore: +65 6779 9091  
fa-info@sg.pepperl-fuchs.com

 **PEPPERL+FUCHS**

## Technical Data





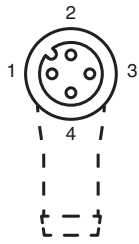

|              |     |
|--------------|-----|
| Flammability | FT2 |
|--------------|-----|

## Connection



- 1) ————— BN
- 2) ————— WH
- 3) ————— BU
- 4) ————— BK

## Accessories

|   |                              |  |
|---|------------------------------|--|
|    | <b>MH V1-SCREWDRIVER</b>     | Torque screwdriver (0.6 Nm)                      |
|    | <b>MH V1-BIT M12</b>         | plug-in cap M12                                  |
|    | <b>V1/V3-LABELHOLDER</b>     | Label holder                                     |
|   | <b>V1/V3-LABEL</b>           | Label plate                                      |
|  | <b>MH V1-Holder</b>          | Modular universal holder for M12 connectors      |
|  | <b>V1-CLIP</b>               | Unlocking protector for M12 connector            |
|  | <b>V1-MARKING-RING-COLOR</b> | Marking rings for M12 connectors, various colors |

Release date: 2023-08-23 Date of issue: 2023-08-23 Filename: 239999-100007\_eng.pdf