



Retroreflective sensor OBR15M-R201-2EP-IO-0,3M-V31



- Medium design with versatile mounting options
- Extended temperature range
-40 °C ... 60 °C
- High degree of protection IP69K
- IO-Link interface for service and process data

Retroreflective sensor with polarization filter



IO-Link

Function

The optical sensors in the series are the first devices to offer an end-to-end solution in a medium-sized standard design – from the thru-beam sensor through to the measuring distance sensor. As a result of this design, the sensors are able to perform practically all standard automation tasks.

The entire series enables sensors to communicate via IO-Link.

The DuraBeam laser sensors are durable and can be used in the same way as a standard sensor.

Multi Pixel Technology (MPT) ensures that the standard sensors are flexible and can be adapted to the application environment.

Dimensions

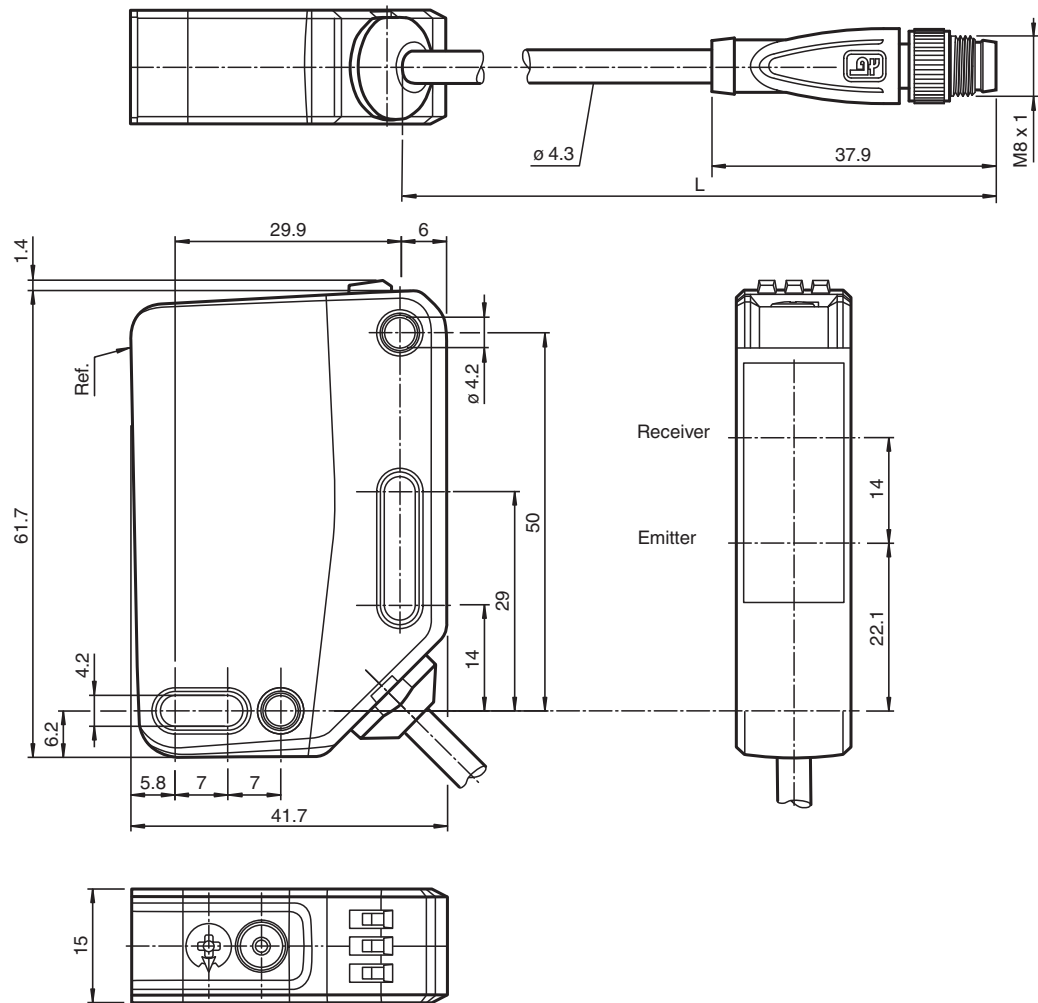

Technical Data

General specifications

Effective detection range	0 ... 15 m
Reflector distance	0.02 ... 15 m
Threshold detection range	18.5 m
Reference target	H85-2 reflector
Light source	LED
Light type	modulated visible red light
LED risk group labelling	exempt group
Polarization filter	yes
Diameter of the light spot	approx. 520 mm at a distance of 15 m
Opening angle	2 °
Ambient light limit	EN 60947-5-2 : 60000 Lux

Functional safety related parameters

MTTF _d	724 a
Mission Time (T _M)	20 a
Diagnostic Coverage (DC)	0 %

Indicators/operating means

Operation indicator	LED green: constantly on - power on flashing (4Hz) - short circuit flashing with short break (1 Hz) - IO-Link mode
---------------------	---

Technical Data

Function indicator		Yellow LED: Permanently lit - light path clear Permanently off - object detected Flashing (4 Hz) - insufficient operating reserve
Control elements		Light-on/dark-on changeover switch
Control elements		sensitivity adjustment
Electrical specifications		
Operating voltage	U_B	10 ... 30 V DC
Ripple		max. 10 %
No-load supply current	I_0	< 18 mA at 24 V Operating voltage
Protection class		III
Interface		
Interface type		IO-Link (via C/Q = pin 4)
IO-Link revision		1.1
Device profile		Identification and diagnosis Smart Sensor type 2.4
Device ID		0x111211 (1118737)
Transfer rate		COM2 (38.4 kBit/s)
Min. cycle time		2.3 ms
Process data width		Process data input 2 Bit Process data output 2 Bit
SIO mode support		yes
Compatible master port type		A
Output		
Switching type		The switching type of the sensor is adjustable. The default setting is: C/Q - Pin4: NPN normally open / dark-on, PNP normally closed / light-on, IO-Link /Q - Pin2: NPN normally closed / light-on, PNP normally open / dark-on
Signal output		2 push-pull (4 in 1) outputs, short-circuit protected, reverse polarity protected, overvoltage protected
Switching voltage		max. 30 V DC
Switching current		max. 100 mA , resistive load
Usage category		DC-12 and DC-13
Voltage drop	U_d	≤ 1.5 V DC
Switching frequency	f	1000 Hz
Response time		0.5 ms
Conformity		
Communication interface		IEC 61131-9
Product standard		EN 60947-5-2
Approvals and certificates		
UL approval		E87056 , cULus Listed , class 2 power supply , type rating 1
CCC approval		CCC approval / marking not required for products rated ≤36 V
Ambient conditions		
Ambient temperature		-40 ... 60 °C (-40 ... 140 °F) , fixed cable -20 ... 60 °C (-4 ... 140 °F) , movable cable not appropriate for conveyor chains
Storage temperature		-40 ... 70 °C (-40 ... 158 °F)
Mechanical specifications		
Housing width		15 mm
Housing height		61.7 mm
Housing depth		41.7 mm
Degree of protection		IP67 / IP69 / IP69K
Connection		fixed cable 300 mm with M8 x 1 male connector; 4-pin
Material		
Housing		PC (Polycarbonate)
Optical face		PMMA
Mass		approx. 51 g
Cable length		0.3 m

Release date: 2023-05-09 Date of issue: 2023-05-09 Filename: 295670-100063_eng.pdf

Connection

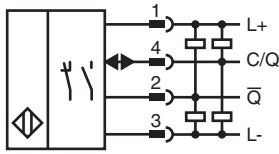

Connection Assignment



Wire colors in accordance with EN 60947-5-2

- 1 | BN (brown)
- 2 | WH (white)
- 3 | BU (blue)
- 4 | BK (black)

Assembly

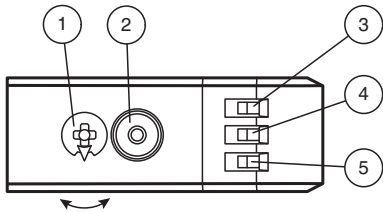

1	Sensitivity adjustment	
2	Light-on / dark-on changeover switch	
3	Operating indicator / dark on	GN
4	Signal indicator	YE
5	Operating indicator / light on	GN

Characteristic Curve

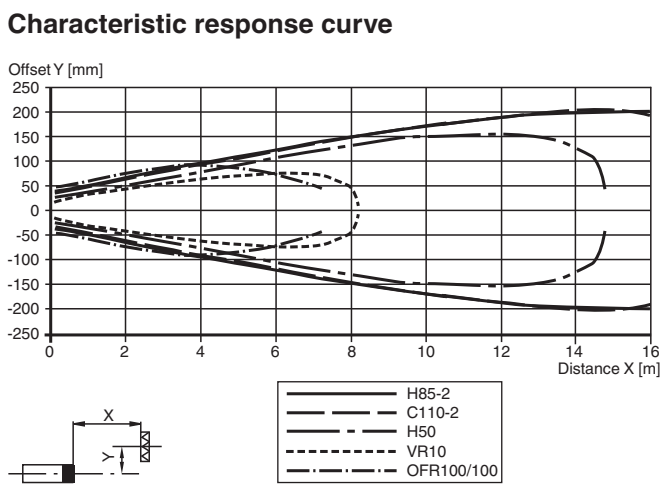

Release date: 2023-05-09 Date of issue: 2023-05-09 Filename: 295670-100063_eng.pdf

Characteristic Curve

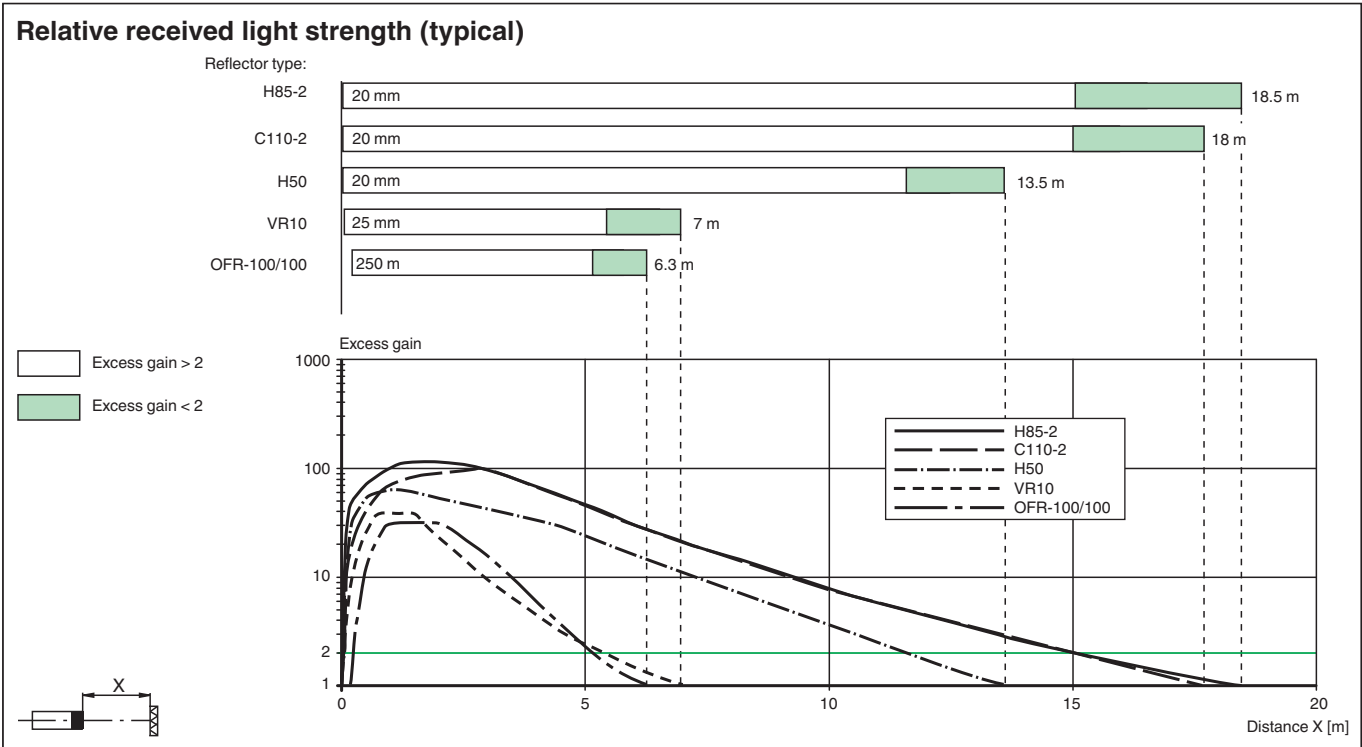

Commissioning

To unlock the adjustment functions turn the sensing range / sensitivity adjuster for more than 180 degrees.

Sensing Range / Sensitivity

Turn sensing range / sensitivity adjuster clockwise to increase sensing range / sensitivity.
 Turn sensing range / sensitivity adjuster counter clockwise to decrease sensing range / sensitivity.
 If the end of the adjustment range is reached, the signal indicator starts flashing with 8 Hz.

Light-on / Dark-on Configuration

Press the light-on / dark-on changeover switch for more than 1 second (less than 4 seconds). The light-on / dark-on mode changes and the operating indicators are activated accordingly.
 If you press the light-on / dark-on changeover switch for more than 4 seconds, the light-on / dark-on mode changes back to the original setting. On release of the light-on / dark-on changeover switch the current state is activated.

Restore Factory Settings

Press the light-on / dark-on changeover switch for more than 10 seconds (less than 30 seconds) until all LEDs turn off. On release of the light-on / dark-on changeover switch the signal indicator turns on. After 5 seconds the sensor resumes operation with factory default settings.
 After 5 minutes of inactivity the sensing range / sensitivity adjustment is locked. In order to reactivate the sensing range / sensitivity adjustment, turn the sensing range / sensitivity adjuster for more than 180 degrees.

















Accessories

	REF-H85-2	Reflector, rectangular 84.5 mm x 84.5 mm, mounting holes
	REF-C110-2	Reflector, round ø 84 mm, central mounting hole
	REF-H50	Reflector, rectangular 51 mm x 61 mm, mounting holes, fixing strap
	REF-VR10	Reflector, rectangular 60 mm x 19 mm, mounting holes
	OFR-100/100	Reflective tape 100 mm x 100 mm
	OMH-RL31-02	Mounting bracket narrow

Release date: 2023-05-09 Date of issue: 2023-05-09 Filename: 295670-100063_eng.pdf

Refer to "General Notes Relating to Pepperl+Fuchs Product Information".

Accessories

	OMH-RL31-03	Mounting bracket narrow
	OMH-RL31-04	Mounting aid for round steel \varnothing 12 mm or sheet 1.5 mm ... 3 mm
	OMH-RL31-07	Mounting bracket including adjustment
	OMH-RL31-08	Mounting aid for round steel \varnothing 12 mm or sheet 1.5 mm ... 3 mm
	OMH-R20x-Quick-Mount	Quick mounting accessory
	ICE2-8IOL-G65L-V1D	EtherNet/IP IO-Link master with 8 inputs/outputs
	ICE3-8IOL-G65L-V1D	PROFINET IO IO-Link master with 8 inputs/outputs
	ICE2-8IOL-K45S-RJ45	EtherNet/IP IO-Link master with 8 inputs/outputs, DIN rail, screw terminal
	ICE3-8IOL-K45P-RJ45	PROFINET IO IO-Link master with 8 inputs/outputs, DIN rail, push-in terminals
	ICE3-8IOL-K45S-RJ45	PROFINET IO IO-Link master with 8 inputs/outputs, DIN rail, screw terminal
	IO-Link-Master02-USB	IO-Link master, supply via USB port or separate power supply, LED indicators, M12 plug for sensor connection
	ICE1-8IOL-G30L-V1D	Ethernet IO-Link module with 8 inputs/outputs
	ICE1-8IOL-G60L-V1D	Ethernet IO-Link module with 8 inputs/outputs
	ICE2-8IOL-K45P-RJ45	EtherNet/IP IO-Link master with 8 inputs/outputs, DIN rail, push-in connectors
	V31-GM-2M-PUR	Female cordset single-ended M8 straight A-coded, 4-pin, PUR cable grey
	V31-WM-2M-PUR	Female cordset single-ended M8 angled A-coded, 4-pin, PUR cable grey