



Industrial Communication ICA-IIOT-KIT2G-IO

- Experience the benefits of IO-Link
- See how simple it is to integrate IO-Link data into your I4.0 strategy
- Quick start guide for basic connectivity to the IO-Link master
- Detailed instructions for MQTT and OPC UA connectivity
- EtherNet/IP interface

IIoT Starter Kit with IP67 EtherNet/IP Master



Function

Learn how to visualize and analyze sensor data with this IIoT Starter Kit and our simple-to-use IO-Link masters.

Each kit includes the following components to get you started:

- An IO-Link master with 8 inputs/outputs
- A high-frequency RFID R/W station with IO-Link
- Three IO-Link sensors
- All the necessary cabling, including an Ethernet bus cable and female cordset
- An Ethernet unmanaged switch with 5 RJ45 ports and port alarm
- Two RFID transponders
- A Pepperl+Fuchs PS1000 power supply (100 VAC to 240 VAC wide range input; output 24 VDC, 5 A, 120 W)







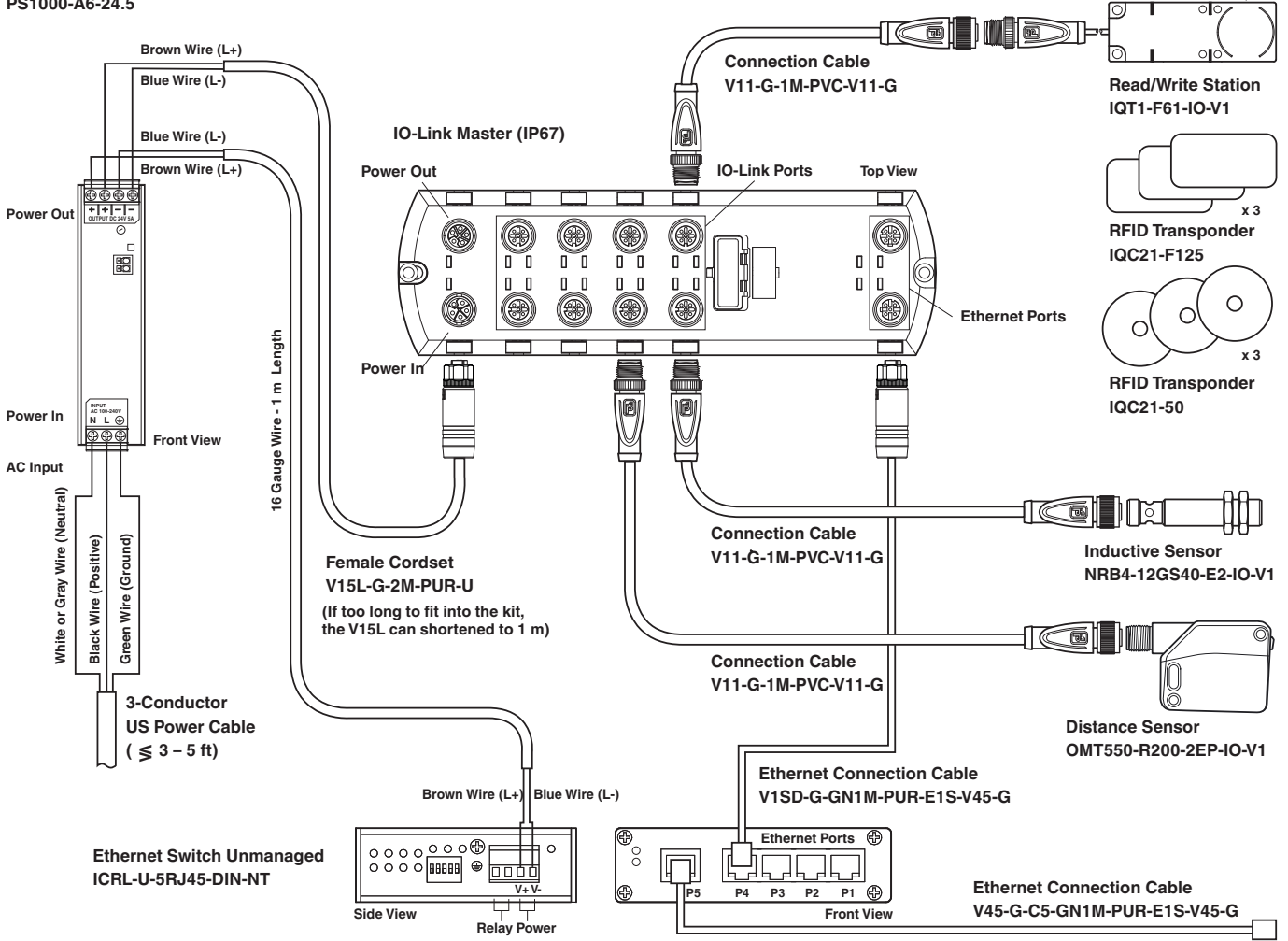

The kit includes a list of protocol details as well as instructions that walk the user through setup and IO-Link master configurations.

Application

Power Supply
PS1000-A6-24.5





Matching System Components

	IQC21-F125	Data carrier
	V15L-G-2M-PUR-U	Female cordset single-ended M12 straight L-coded, 5-pin, PUR cable grey, UL approved
	V45-G-C5-GN1M-PUR-E1S-V45-G	Ethernet bus cable RJ45 to RJ45 PROFINET-coded, 4-pin, PUR cable green, Cat5e, shielded, UL approved, drag chain suitable
	ICRL-U-5RJ45-DIN-NT	Ethernet unmanaged switch with 5 RJ45 ports and port alarm
	IQT1-F61-IO-V1	HF read/write station with IO-Link in accordance with ISO 15693
	NRB4-12GS40-E2-IO-V1	Inductive sensor
	OMT550-R200-2EP-IO-V1	Distance sensor
	PS1000-A6-24.5	Power Supply

Release date: 2022-08-04 Date of issue: 2022-08-04 Filename: 70140310_eng.pdf

Refer to "General Notes Relating to Pepperl+Fuchs Product Information".

Matching System Components

	<p>IQC21-50 25pcs</p>	<p>Data carrier</p>
	<p>V11-G-1M-PVC-V11-G</p>	<p>Cordset M12 socket straight to M12 plug straight A-coded, 3-pin, PVC cable grey</p>

Release date: 2022-08-04 Date of issue: 2022-08-04 Filename: 70140310_eng.pdf

Refer to "General Notes Relating to Pepperl+Fuchs Product Information".

Pepperl+Fuchs Group
www.pepperl-fuchs.com

USA: +1 330 486 0001
fa-info@us.pepperl-fuchs.com

Germany: +49 621 776 1111
fa-info@de.pepperl-fuchs.com

Singapore: +65 6779 9091
fa-info@sg.pepperl-fuchs.com