



Stationary read device

OPC70P-F201-R2-45



- Reads 1-D and 2-D codes at high speeds of up to 10 m/s at 100 readings/s
- High depth of focus
- Logo comparison
- Rotary encoder input
- Reliable on reflective surfaces through polarization filter technology
- Presence detection

Optical Print Inspector, reads all common 1-D and 2-D codes, detects logos, Ethernet, RS 232, speeds of up to 10 m/s; polarization filter



Function

With the Optical Print Inspector, Pepperl+Fuchs provides the solution to code reading and detection tasks in the field of printing, paper, and packaging. Whether reading 1-D and 2-D codes at high speeds, reading reliably on reflective surfaces and at varying intervals, with overly long barcodes or performing diverse detection tasks with the Optical Print Inspector, you always have the right Vision Sensor at your disposal.

Dimensions

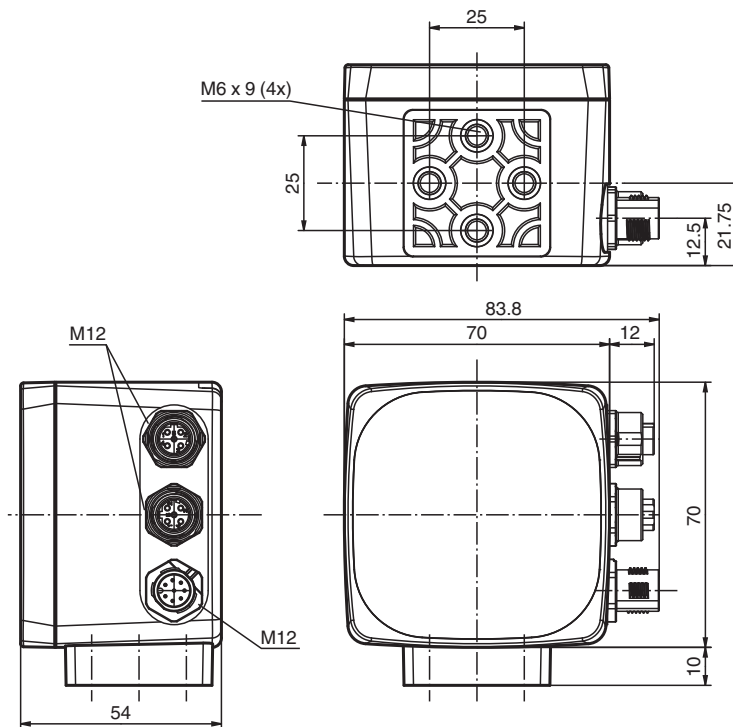

Technical Data

General specifications

Light type	Integrated LED lightning (white)
Polarization filter	yes
Symbologies	Data Matrix, Code 39, Code 128, Int 2 of 5, EAN13, Pharmacode

Release date: 2023-04-20 Date of issue: 2023-04-20 Filename: 264852_eng.pdf

Refer to "General Notes Relating to Pepperl+Fuchs Product Information".

Pepperl+Fuchs Group
www.pepperl-fuchs.com

USA: +1 330 486 0001
fa-info@us.pepperl-fuchs.com

Germany: +49 621 776 1111
fa-info@de.pepperl-fuchs.com

Singapore: +65 6779 9091
fa-info@sg.pepperl-fuchs.com

pf PEPPERL+FUCHS

Technical Data

Read distance		45 ... 90 mm Nominal distance: 70 mm
Reading field		Minimum read field: 22 mm x 30 mm Read field at nominal distance: 28 mm x 45 mm Maximum read field: 35 mm x 55 mm
Modul size		Minimum module size: 0.15 mm
Evaluation frequency		up to 100 Hz
Target velocity		triggered max. 10 m/s
Data Matrix		
Symbol size		rectangular up to 144 x 144 modules rectangular up to 16 x 48 modules
Data format		ASCII, C40, Text, X12, Edifact, Base 256 , all according to ISO 646
Orientation		omnidirectional
Nominal ratings		
Camera		
Type		CMOS , Global shutter
Number of pixels		752 x 480 pixels
Gray scale		256
Image recording		real-time , Program-controlled or triggered externally
Functional safety related parameters		
MTTF _d		40.5 a
Mission Time (T _M)		8 a
Diagnostic Coverage (DC)		0 %
Indicators/operating means		
Operation indicator		LED green: Ready for operation
LED indication		for good/poor reading
Electrical specifications		
Operating voltage	U _B	24 V DC ± 15% , PELV
No-load supply current	I ₀	max. 250 mA
Power consumption	P ₀	6 W
Interface		
Interface type		serial , RS 232
Transfer rate		max. 115.2 kBit/s
Cable length		max. 30 m
Interface 1		
Interface type		Ethernet
Protocol		TCP/IP
Transfer rate		100 MBit/s
Cable length		max. 30 m
Input		
Input voltage		to be applied externally 24 V ± 15% PELV
Number/Type		Trigger
Input current		approx. 10 mA at 24 V DC
Switching threshold		low: < 10 V, high: > 15 V
Cable length		max. 30 m
Output		
Number/Type		GOOD, BAD, Matchcode
Switching type		PNP
Switching voltage		to be applied externally 24 V ± 15 % PELV
Switching current		100 mA each output
Cable length		max. 30 m
Compliance with standards and directives		
Standard conformity		
Noise immunity		EN 61326-1:2006

Release date: 2023-04-20 Date of issue: 2023-04-20 Filename: 264852_eng.pdf

Technical Data

Emitted interference	EN 61000-6-4:2007/A1:2011
Degree of protection	EN 60529
Photobiological safety	Risk group 1 according to IEC 62471
Approvals and certificates	
UL approval	cULus Listed, General Purpose, Class 2 Power Source, Type 1 enclosure
CCC approval	CCC approval / marking not required for products rated ≤36 V
Approvals	CE
Ambient conditions	
Ambient temperature	0 ... 45 °C (32 ... 113 °F)
Storage temperature	-20 ... 60 °C (-4 ... 140 °F)
Mechanical specifications	
Degree of protection	IP67
Connection	8-pin, M12x1 connector, standard (supply+IO) , 5-pin, M12x1 socket, standard (RS 232) , 4-pin, M12x1 socket, standard (LAN)
Material	
Housing	PC/ABS
Installation	4 x M6 threading
Mass	approx. 160 g

Connection

RS 232



Pin	Signal
1	+UB
2	TX RS232
3	GND
4	RX RS232
5	NC

LAN



Pin	Signal
1	TX+ Ethernet
2	RX+ Ethernet
3	TX- Ethernet
4	RX- Ethernet

(24 V DC + I/O)

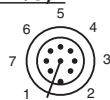

Pin	Signal
1	IN Trigger
2	+UB
3	OUT Good
4	OUT Bad
5	IN 1
6	IN Encoder A
7	GND
8	OUT Matchcode

Assembly

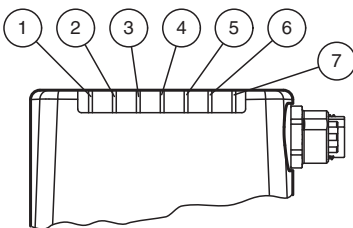





1	LED DIAG2	yellow
2	LED DIAG1	yellow
3	LED POWER	green
4	LED READY	yellow
5	LED BAD	yellow
6	LED GOOD	yellow
7	LED TRIGGER	yellow

Release date: 2023-04-20 Date of issue: 2023-04-20 Filename: 264852_eng.pdf

Refer to "General Notes Relating to Pepperl+Fuchs Product Information".

Accessories

	V19-G-2M-PUR-ABG	Female cordset single-ended M12 straight A-coded, 8-pin, PUR cable grey, shielded
	V15S-G-5M-PUR-ABG	Male cordset single-ended M12 straight A-coded, 5-pin, PUR cable grey, shielded
	V1SD-G-2M-PUR-ABG-V45-G	Connection cable, M12 to RJ-45, PUR cable 4-pin, CAT5e
	V19-G-ABG-PG9	Female connector M12 straight A-coded 8-pin, for cable diameter 5 - 8 mm, shielded, field-attachable
	V19-G-0,2M-YOPC-0,2M-V1S/V31-G	Y connection cable M12 socket straight A-coded 8-pin to M12 plug / M8 socket straight A-coded 4-pin, 3x PUR cable grey, shielded