

Female cordset

V15-W-BK5M-PUR-U/0,75



- Suitable for drag chains and abrasion resistant
- Degree of protection IP68 / IP69
- Resistant to microbes and hydrolysis
- UV resistant
- UL listed for USA and Canada
- Halogen-free
- Specific design protects against loosening and inaccurate installation

Female cordset single-ended M12 angled A-coded, 5-pin, PUR cable black, UL approved, drag chain suitable



Dimensions

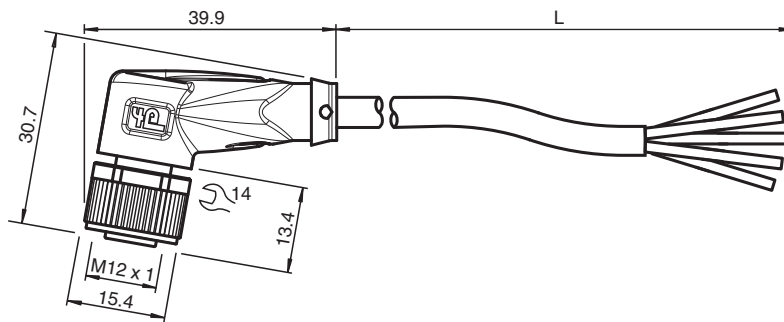

Technical Data

General specifications

Connector 1	
Connection	socket
Construction type	M12
Style	angled
Locking	screw connection
Number of pins	5
Coding	A-coded
Connector 2	
Connection	cable end

Electrical specifications

Operating voltage	U_B	max. 48 V AC / 60 V DC
Operating current	I_B	max. 4 A

Conformity

Degree of protection	EN 60529
Plug connection	connector M12 x 1 : IEC 61076-2-101
Halogen-free	IEC 60754-1

Approvals and certificates

UL approval	AWM STYLE 20549 AWM I/II A/B 80°C 300V FT2 (cable)
UL File Number	E231213

Ambient conditions

Release date: 2023-09-04 Date of issue: 2023-09-05 Filename: 239999-0002_eng.pdf

Refer to "General Notes Relating to Pepperl+Fuchs Product Information".

Technical Data

Ambient temperature		
Plug connector		-40 ... 90 °C (-40 ... 194 °F)
Cable, fixed		-40 ... 80 °C (-40 ... 176 °F)
Cable, flexing		-20 ... 80 °C (-4 ... 176 °F)
Pollution degree		3
Mechanical specifications		
Plug connector		
Tightening torque		0.6 Nm
Loosening protection		available
Tool installation		straight knurling and hexagon nut SW = 14 mm
Mating cycles		min. 100
Degree of protection		IP68 / IP69
Cable		
Sheath diameter		6 mm
Bending radius		> 10 x cable diameter, moving > 5 x cable diameter, fixed
Sheath stripping force		max. 50 N / 300 mm
Sheath color		black (similar to RAL 9005)
Number of cores		5
Core cross section		0.75 mm ²
Cores color		Core 1: brown Core 2: white Core 3: blue Core 4: black Core 5: grey
Core construction		42 x 0.15 mm Ø
Length	L	5 m
Cable code		Li F 9Y 11Y 5 x 0,75
Drag chain suitability		
Drag chain cycles		min. 2000000
Motion velocity		max. 3.3 m/s
Traverse distance		max. 5 m
Acceleration		max. 5 m/s ²
Torsional stress		± 180 °/m
Material		
Halogen-free		yes
Plug connector		
Screw connection		Zinc diecast, nickel-plated
Body		TPU, black
Seal		FKM
Contact surface		gold plated (Au)
Flammability		V-2
Cable		
Sheathing		PUR based on polyether
Core insulation		PP
UV resistance		yes
Oil resistance		yes
Microbial resistance		yes
Hydrolysis resistance		yes
Flammability		FT2

Release date: 2023-09-04 Date of issue: 2023-09-05 Filename: 239999-0002_eng.pdf

Refer to "General Notes Relating to Pepperl+Fuchs Product Information".





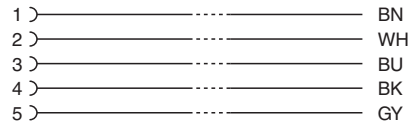
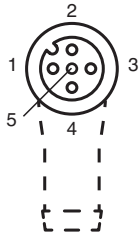

Pepperl+Fuchs Group
www.pepperl-fuchs.comUSA: +1 330 486 0001
fa-info@us.pepperl-fuchs.comGermany: +49 621 776 1111
fa-info@de.pepperl-fuchs.comSingapore: +65 6779 9091
fa-info@sg.pepperl-fuchs.com

PEPPERL+FUCHS

Connection



Accessories

	MH V1-SCREWDRIVER	Torque screwdriver (0.6 Nm)
	MH V1-BIT M12	plug-in cap M12
	V1/V3-LABELHOLDER	Label holder
	V1/V3-LABEL	Label plate
	MH V1-Holder	Modular universal holder for M12 connectors
	V1-CLIP	Unlocking protector for M12 connector
	V1-MARKING-RING-COLOR	Marking rings for M12 connectors, various colors