



## Triangulation sensor (BGS)

### OBT1250-R202-K2



- Version for universal voltages
- Medium design with versatile mounting options
- Degree of protection IP67
- Mounting on full metal sockets
- Very bright, highly visible light spot
- Highly visible LEDs for Power ON and switching state
- Easy to use
- Image is generic for this device type and may deviate from the specific variant



## Function

The optical sensors of this series for applications in standard automation have a modern housing design. The sensors are characterized by the many mounting options, easy handling and highly visible LED status indicators. The integrated full metal bushings ensure long-term secure and dimensionally stable mounting.

Due to the integrated all-voltage power supply, the sensors can be operated in the range of 24 ... 240 V AC/DC.

Dimensions

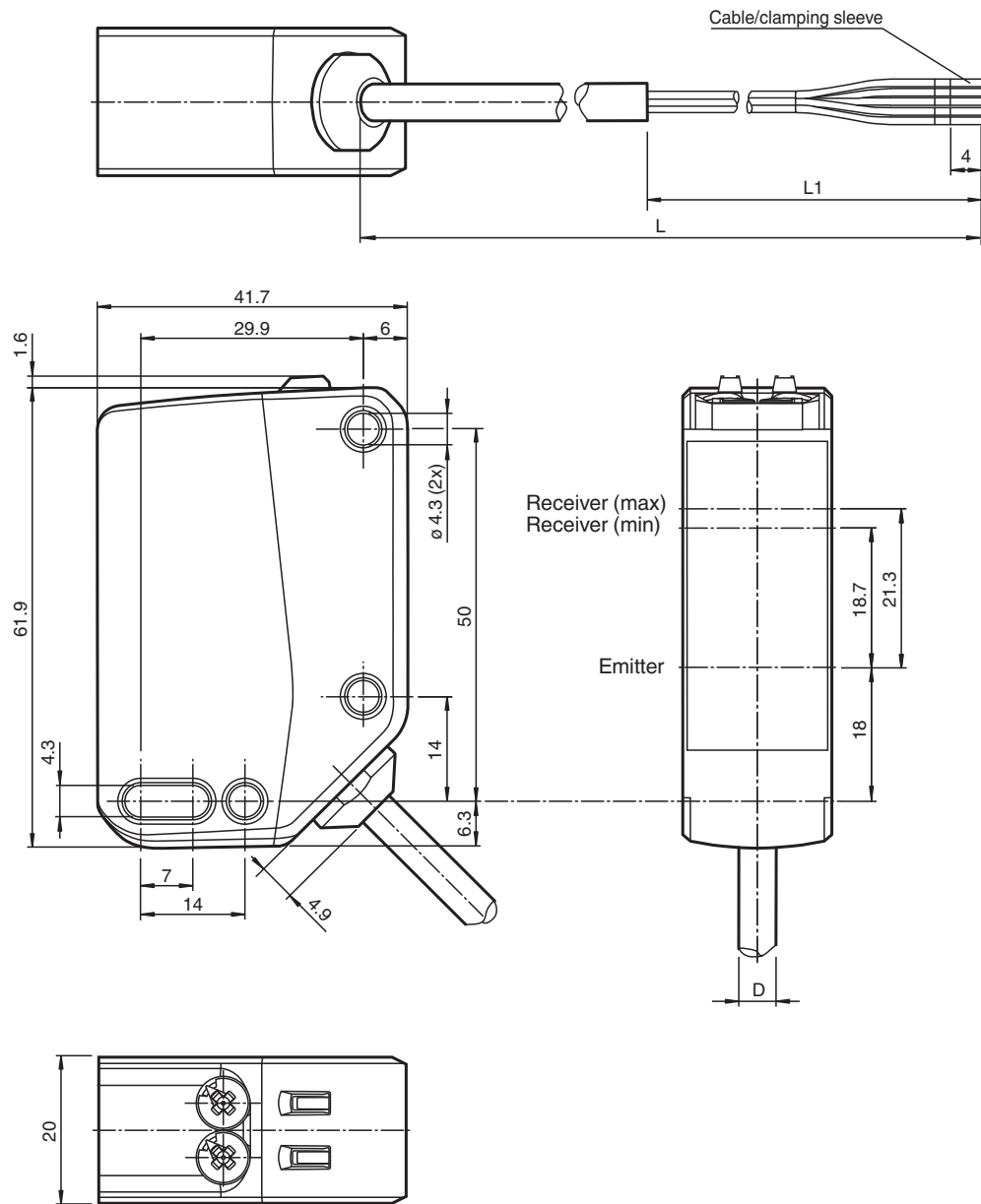

Technical Data

General specifications	
Detection range	0 ... 1250 mm
Detection range min.	0 ... 200 mm
Detection range max.	0 ... 1250 mm
Adjustment range	200 ... 1250 mm
Reference target	standard white, 100 mm x 100 mm
Light source	LED
Light type	modulated visible red light

Release date: 2023-09-28 Date of issue: 2023-09-28 Filename: 70128080-100023\_eng.pdf

Refer to "General Notes Relating to Pepperl+Fuchs Product Information".

Pepperl+Fuchs Group  
www.pepperl-fuchs.com

USA: +1 330 486 0001  
fa-info@us.pepperl-fuchs.com

Germany: +49 621 776 1111  
fa-info@de.pepperl-fuchs.com

Singapore: +65 6779 9091  
fa-info@sg.pepperl-fuchs.com

**PF** PEPPERL+FUCHS

## Technical Data

LED risk group labelling		exempt group
Black-white difference (6 %/90 %)		< 40 % at 1250 mm
Diameter of the light spot		approx. 50 mm at a distance of 1250 mm
Opening angle		3 °
Ambient light limit		EN 60947-5-2 : 30000 Lux
<b>Functional safety related parameters</b>		
MTTF <sub>d</sub>		642 a
Mission Time (T <sub>M</sub> )		20 a
Diagnostic Coverage (DC)		0 %
<b>Indicators/operating means</b>		
Operation indicator		LED green: Power on
Function indicator		LED yellow: constantly on - object detected constantly off - object not detected Flashing (8 Hz) - fault detected, the outputs maintain the status
Control elements		Light-on/dark-on changeover switch
Control elements		Sensing range adjuster
<b>Electrical specifications</b>		
Operating voltage	U <sub>B</sub>	24 ... 240 V AC/DC
No-load supply current	I <sub>0</sub>	< 30 mA at 24 V Operating voltage
Protection class		II
Rated insulation voltage	U <sub>i</sub>	250 V
Rated impulse withstand voltage	U <sub>imp</sub>	2500 V
Power consumption	P <sub>0</sub>	≤ 3.5 VA
Fuse		Safety fuse ≤ 2 A (slow-blow) according to IEC 60127-2 Sheet 1 Recommendation: after a short circuit, check that the device is functioning correctly.
<b>Output</b>		
Switching type		The switching type of the sensor is adjustable. The default setting is: Q - BK: normally-open / light-on /Q - GY: normally-closed / dark-on C - WH: Common
Signal output		Relay, 1 alternator
Switching voltage		max. 240 V AC/DC
Switching current		max. 2.5 A , see section characteristic curve
Switching power		DC: max. 95 W AC: max. 600 VA
Usage category		DC-12 , DC-13 , AC-12 u. AC-140
Switching frequency	f	25 Hz
Response time		≤ 20 ms
<b>Conformity</b>		
Product standard		EN 60947-5-2 , EN 60947-1
<b>Approvals and certificates</b>		
UL approval		E87056 , cULus Listed
<b>Ambient conditions</b>		
Ambient temperature		-30 ... 60 °C (-22 ... 140 °F) , fixed cable -20 ... 60 °C (-4 ... 140 °F) , movable cable not appropriate for conveyor chains
Storage temperature		-40 ... 70 °C (-40 ... 158 °F)
Pollution degree		3
<b>Mechanical specifications</b>		
Housing width		20 mm
Housing height		62 mm
Housing depth		42 mm
Degree of protection		IP67
Connection		2 m fixed cable
<b>Material</b>		
Housing		PC (Polycarbonate)
Optical face		PMMA

Release date: 2023-09-28 Date of issue: 2023-09-28 Filename: 70128080-100023\_eng.pdf

Refer to "General Notes Relating to Pepperl+Fuchs Product Information".

Pepperl+Fuchs Group  
www.pepperl-fuchs.comUSA: +1 330 486 0001  
fa-info@us.pepperl-fuchs.comGermany: +49 621 776 1111  
fa-info@de.pepperl-fuchs.comSingapore: +65 6779 9091  
fa-info@sg.pepperl-fuchs.com

**PEPPERL+FUCHS**

**Technical Data**

Mass	approx. 120 g
Cable length	2 m

**Connection**

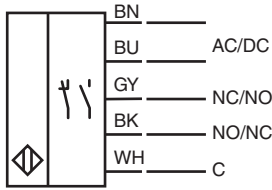

**Assembly**

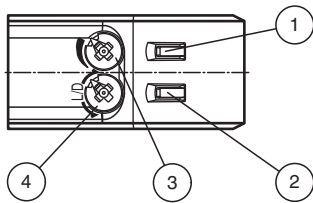

1	Function indicator	YE
2	Operation indicator	GN
3	Sensitivity adjuster	
4	Light-on / dark-on changeover switch	

**Characteristic Curve**

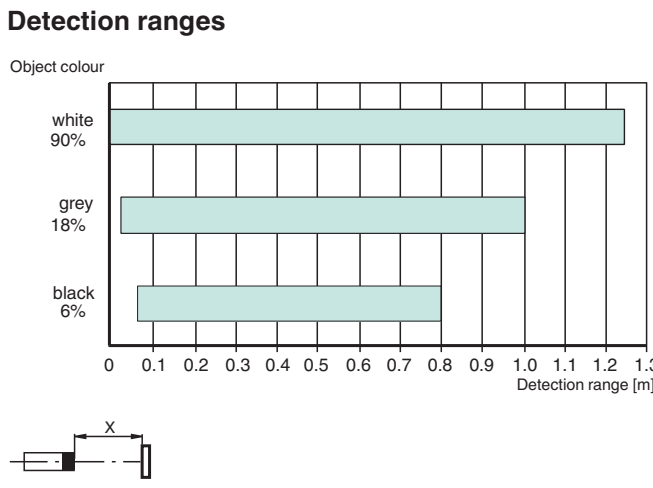
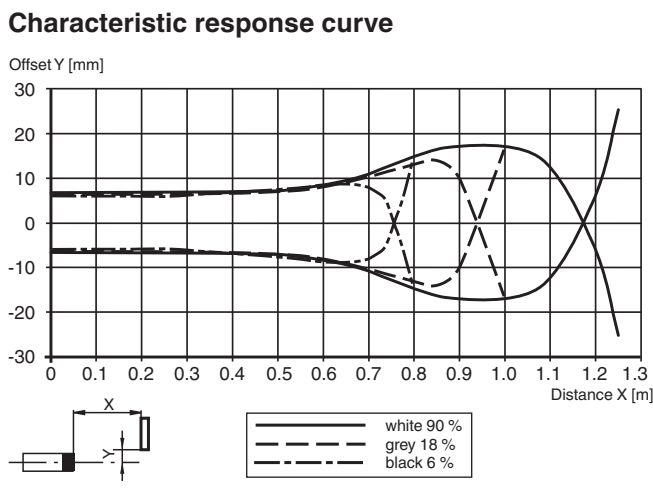

Release date: 2023-09-28 Date of issue: 2023-09-28 Filename: 70128080-100023\_eng.pdf

Refer to "General Notes Relating to Pepperl+Fuchs Product Information".

**Characteristic Curve**

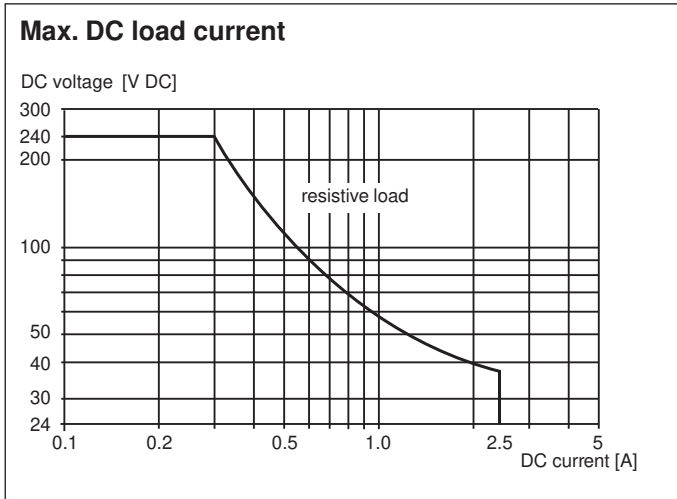
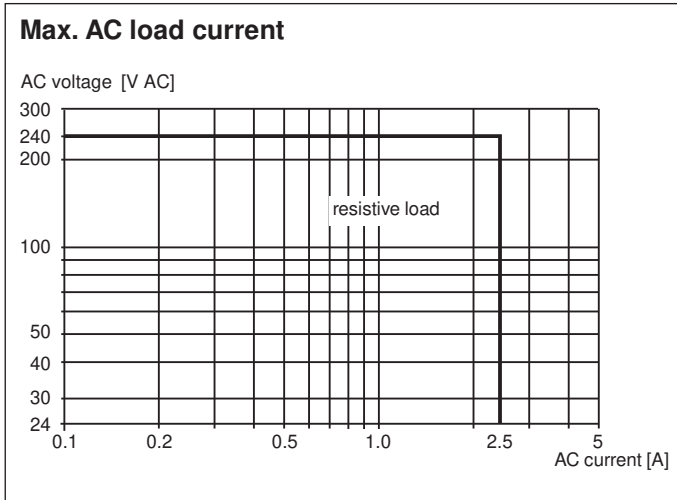
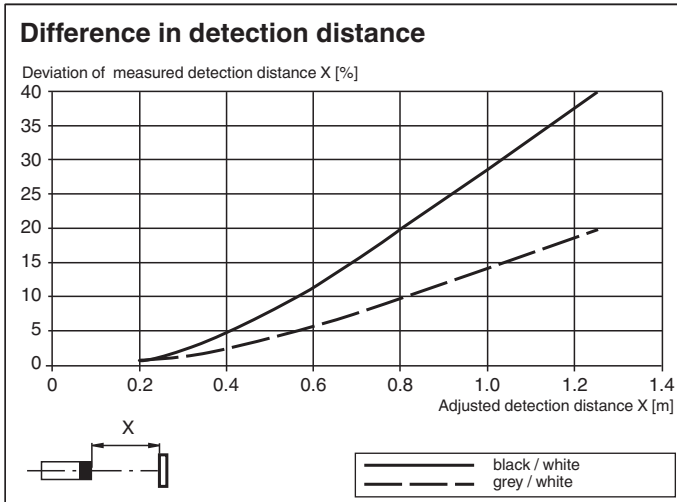

**Commissioning**

**Sensing Range / Sensitivity**

Turn sensing range / sensitivity adjuster clockwise to increase sensing range / sensitivity.  
 Turn sensing range / sensitivity adjuster counter clockwise to decrease sensing range / sensitivity.  
 The internal end stop signals the end of the adjustment range.



**Light-on / Dark-on Configuration**

To set light switching or dark switching, turn the light/dark changeover switch to the end stop:

- clockwise: dark switching
- counterclockwise: light switching

Release date: 2023-09-28 Date of issue: 2023-09-28 Filename: 70128080-100023\_eng.pdf

**Accessories**

	<b>OMH-RL31-02</b>	Mounting bracket narrow
	<b>OMH-R202-02</b>	Mounting aid for round steel ø 12 mm or sheet 1.5 mm ... 3 mm
	<b>OMH-R202-01</b>	Mounting aid for round steel ø 12 mm or sheet 1.5 mm ... 3 mm

Release date: 2023-09-28 Date of issue: 2023-09-28 Filename: 70128080-100023\_eng.pdf

Refer to "General Notes Relating to Pepperl+Fuchs Product Information".

Pepperl+Fuchs Group  
www.pepperl-fuchs.com

USA: +1 330 486 0001  
fa-info@us.pepperl-fuchs.com

Germany: +49 621 776 1111  
fa-info@de.pepperl-fuchs.com

Singapore: +65 6779 9091  
fa-info@sg.pepperl-fuchs.com