



# Retroreflective sensor

## OBR2000-R3-E1-P-L



- Ultra-small housing design
- DuraBeam Laser Sensors - durable and employable like an LED
- 45° cable outlet for maximum mounting freedom under extremely tight space constraints

Laser retroreflective sensor, ultra-small design with M3 mounting, polarization filter, 2000 mm detection range, light on, NPN output, 2 m fixed cable



### Function

The nano sensor has been developed for a broad range of applications. It offers excellent durability and is exceptionally easy to install. The housing is compact and, with its 45° cable outlet, can be installed in the smallest spaces. New functional principles and functionality open up a range of new options.

### Dimensions

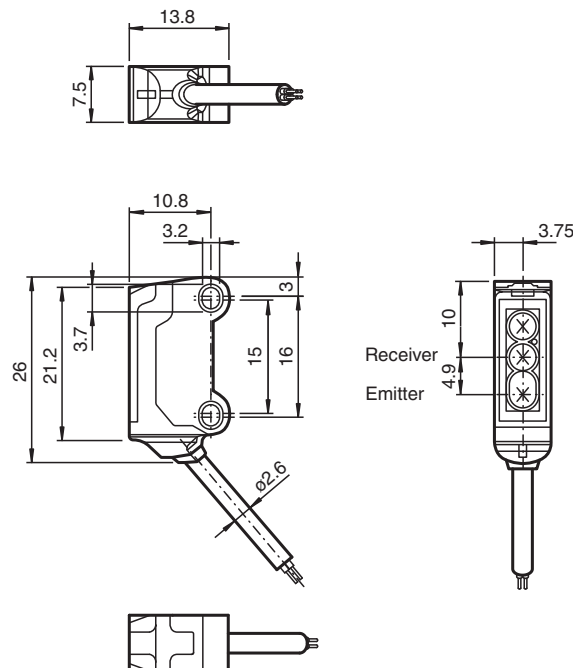

### Technical Data

#### General specifications

Effective detection range	0 ... 2 m
Reflector distance	40 ... 2000 mm
Threshold detection range	2.3 m
Reference target	H40 reflector

Release date: 2023-03-28 Date of issue: 2023-03-28 Filename: 70141819\_eng.pdf

Refer to "General Notes Relating to Pepperl+Fuchs Product Information".

Pepperl+Fuchs Group  
www.pepperl-fuchs.com

USA: +1 330 486 0001  
fa-info@us.pepperl-fuchs.com

Germany: +49 621 776 1111  
fa-info@de.pepperl-fuchs.com

Singapore: +65 6779 9091  
fa-info@sg.pepperl-fuchs.com

**pf** PEPPERL+FUCHS

## Technical Data

Light source	laser diode	
Light type	modulated visible red light , 680 nm	
Polarization filter	yes	
Laser nominal ratings		
Note	LASER LIGHT , DO NOT STARE INTO BEAM	
Laser class	1	
Wave length	680 nm	
Beam divergence	> 5 mrad	
Pulse length	approx. 3 µs	
Repetition rate	approx. 16.6 kHz	
max. pulse energy	8 nJ	
Diameter of the light spot	approx. 35 mm at a distance of 2000 mm	
Opening angle	approx. 0.5 °	
Optical face	frontal	
Ambient light limit	EN 60947-5-2 : 30000 Lux	
<b>Functional safety related parameters</b>		
MTTF <sub>d</sub>	800 a	
Mission Time (T <sub>M</sub> )	20 a	
Diagnostic Coverage (DC)	0 %	
<b>Indicators/operating means</b>		
Operation indicator	LED green, statically lit Power on , short-circuit : LED green flashing (approx. 4 Hz)	
Function indicator	LED yellow: lights up when receiving the light beam ; flashes when falling short of the operating reserve; OFF when light beam is interrupted	
<b>Electrical specifications</b>		
Operating voltage	U <sub>B</sub>	12 ... 24 V
No-load supply current	I <sub>0</sub>	< 10 mA
Protection class	III	
<b>Output</b>		
Switching type	NC contact / light-on	
Signal output	1 NPN output, short-circuit protected, reverse polarity protected, open collector	
Switching voltage	max. 30 V DC	
Switching current	max. 50 mA , resistive load	
Voltage drop	U <sub>d</sub>	≤ 1.5 V DC
Switching frequency	f	approx. 2 kHz
Response time	250 µs	
<b>Conformity</b>		
Product standard	EN 60947-5-2	
Laser safety	EN 60825-1:2007	
<b>Approvals and certificates</b>		
UL approval	E87056 , cULus Recognized, Class 2 Power Source	
CCC approval	CCC approval / marking not required for products rated ≤36 V	
FDA approval	IEC 60825-1 Complies with 21 CFR 1040.10 and 1040.11 except for deviations pursuant to Laser Notice No. 50, dated June 24, 2007	
<b>Ambient conditions</b>		
Ambient temperature	-20 ... 60 °C (-4 ... 140 °F)	
Storage temperature	-30 ... 70 °C (-22 ... 158 °F)	
<b>Mechanical specifications</b>		
Housing width	7.5 mm	
Housing height	26 mm	
Housing depth	13.8 mm	
Degree of protection	IP67	
Connection	2 m fixed cable	
Material		
Housing	PC/ABS and TPU	

Release date: 2023-03-28 Date of issue: 2023-03-28 Filename: 70141819\_eng.pdf

Refer to "General Notes Relating to Pepperl+Fuchs Product Information".

Pepperl+Fuchs Group  
www.pepperl-fuchs.comUSA: +1 330 486 0001  
fa-info@us.pepperl-fuchs.comGermany: +49 621 776 1111  
fa-info@de.pepperl-fuchs.comSingapore: +65 6779 9091  
fa-info@sg.pepperl-fuchs.com

**PEPPERL+FUCHS**

## Technical Data

Optical face	PMMA
Cable	PUR
Mass	approx. 20 g
Cable length	2 m

## Connection

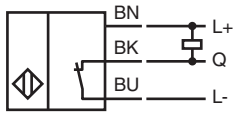

## Assembly

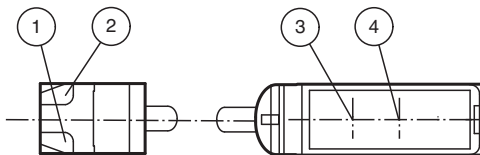

1	Operating display	green
2	Signal display	yellow
3	Emitter	
4	Receiver	

## Characteristic Curve

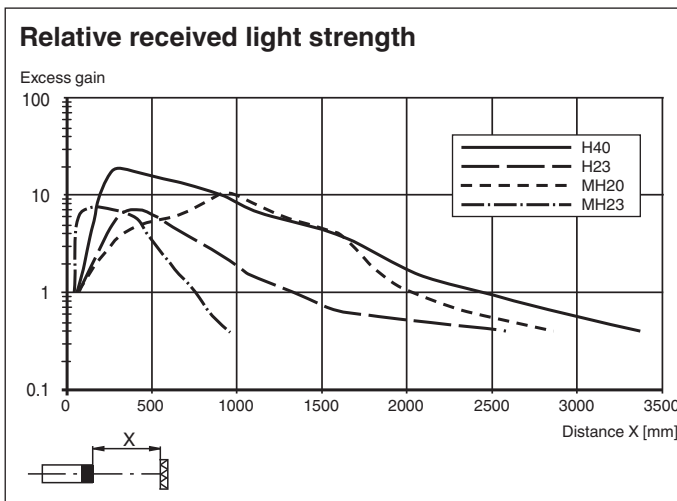

Release date: 2023-03-28 Date of issue: 2023-03-28 Filename: 70141819\_eng.pdf

## Safety Information



## Safety Information

### Laser Class 1 Information

The irradiation can lead to irritation especially in a dark environment. Do not point at people!









Maintenance and repairs should only be carried out by authorized service personnel!

Attach the device so that the warning is clearly visible and readable.

The warning accompanies the device and should be attached in immediate proximity to the device.

Caution – Use of controls or adjustments or performance of procedures other than those specified herein may result in hazardous radiation exposure.

## Accessories

	<b>MH-R3-01</b>	Mounting aid for sensors from the R3 series, mounting bracket
	<b>MH-R3-02</b>	Mounting aid for sensors from the R3 series, mounting bracket
	<b>MH-R3-03</b>	Mounting aid for sensors from the R3 series, mounting bracket
	<b>MH-R3-04</b>	Mounting aid for sensors from the R3 series, mounting bracket
	<b>REF-H40</b>	Reflector, rectangular 47.5 mm x 23.5 mm, mounting holes, fixing strap
	<b>REF-H23</b>	Reflector with mounting holes
	<b>REF-MH20</b>	Reflector with Micro-structure, rectangular 32 mm x 20 mm, mounting holes
	<b>REF-MH23</b>	Reflector with Micro-structure, rectangular 23 mm x 13.8 mm, diagonal mounting hole

Release date: 2023-03-28 Date of issue: 2023-03-28 Filename: 70141819\_eng.pdf

Refer to "General Notes Relating to Pepperl+Fuchs Product Information".

Pepperl+Fuchs Group  
www.pepperl-fuchs.com

USA: +1 330 486 0001  
fa-info@us.pepperl-fuchs.com

Germany: +49 621 776 1111  
fa-info@de.pepperl-fuchs.com

Singapore: +65 6779 9091  
fa-info@sg.pepperl-fuchs.com

 **PEPPERL+FUCHS**