



Ultrasonic sensor

UB6000-F42-E5-V15

- Switching output
- Extremely small unusable area
- TEACH-IN
- Interference suppression (adjustable divergence of sound cone in close range)
- Temperature compensation
- Synchronization options
- NO/NC selectable

Single head system



Dimensions

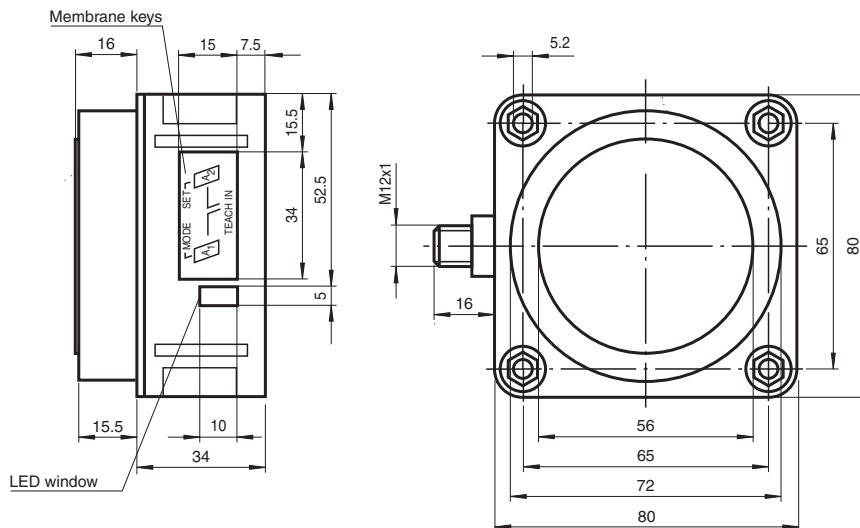

Technical Data

General specifications

| | |
|-----------------------|-----------------|
| Sensing range | 350 ... 6000 mm |
| Adjustment range | 400 ... 6000 mm |
| Dead band | 0 ... 350 mm |
| Standard target plate | 100 mm x 100 mm |
| Transducer frequency | approx. 65 kHz |
| Response delay | approx. 650 ms |

Indicators/operating means

| | |
|-----------|-----------------------|
| LED green | solid green: Power on |
|-----------|-----------------------|

Release date: 2023-02-15 Date of issue: 2023-02-15 Filename: 134006_eng.pdf

Refer to "General Notes Relating to Pepperl+Fuchs Product Information".

Pepperl+Fuchs Group
www.pepperl-fuchs.com

USA: +1 330 486 0001
fa-info@us.pepperl-fuchs.com

Germany: +49 621 776 1111
fa-info@de.pepperl-fuchs.com

Singapore: +65 6779 9091
fa-info@sg.pepperl-fuchs.com

pf PEPPERL+FUCHS

Technical Data

| | | |
|---|-------|--|
| LED yellow | | solid: switching state switch output flashing: program function |
| LED red | | normal operation: "fault" program function: no object detected |
| Electrical specifications | | |
| Operating voltage | U_B | 10 ... 30 V DC , ripple 10 % _{SS} |
| No-load supply current | I_0 | ≤ 60 mA |
| Input/Output | | |
| Synchronization | | bi-directional 0 level: $-U_B \dots +1 \text{ V}$ 1 level: $+4 \text{ V} \dots +U_B$ input impedance: > 12 KOhm synchronization pulse: ≥ 100 μs, synchronization interpulse period: ≥ 2 ms |
| Synchronization frequency | | |
| Common mode operation | | max. 7 Hz |
| Multiplex operation | | ≤ 7/n Hz, n = number of sensors |
| Output | | |
| Output type | | 1 switching output E5, PNP NO/NC, programmable |
| Rated operating current | I_e | 200 mA , short-circuit/overload protected |
| Default setting | | Switch point A1: 400 mm , Switch point A2: 6000 mm , wide sound lobe |
| Voltage drop | U_d | ≤ 2.5 V |
| Repeat accuracy | | ≤ 0.5 % of switching point |
| Switching frequency | f | ≤ 0.6 Hz |
| Range hysteresis | H | 1 % of the set operating distance |
| Temperature influence | | ± 1 % of full-scale value |
| Compliance with standards and directives | | |
| Standard conformity | | |
| Standards | | EN IEC 60947-5-2:2020 IEC 60947-5-2:2019 |
| Approvals and certificates | | |
| UL approval | | cULus Listed, Class 2 Power Source |
| CCC approval | | CCC approval / marking not required for products rated ≤36 V |
| Ambient conditions | | |
| Ambient temperature | | -25 ... 70 °C (-13 ... 158 °F) |
| Storage temperature | | -40 ... 85 °C (-40 ... 185 °F) |
| Mechanical specifications | | |
| Connection type | | Connector plug M12 x 1 , 5-pin |
| Degree of protection | | IP54 |
| Material | | |
| Housing | | ABS |
| Transducer | | epoxy resin/hollow glass sphere mixture; foam polyurethane, cover PBT |
| Mass | | 210 g |

Connection

Standard symbol/Connections:

(version E5, pnp)

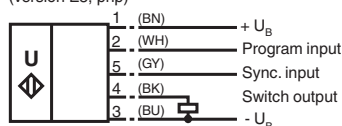

Wire colors in accordance with EN 60947-5-2.

Release date: 2023-02-15 Date of issue: 2023-02-15 Filename: 134006_eng.pdf

Connection Assignment



Wire colors in accordance with EN 60947-5-2

| | | |
|---|----|---------|
| 1 | BN | (brown) |
| 2 | WH | (white) |
| 3 | BU | (blue) |
| 4 | BK | (black) |
| 5 | GY | (gray) |

Characteristic Curve

Characteristic response curve

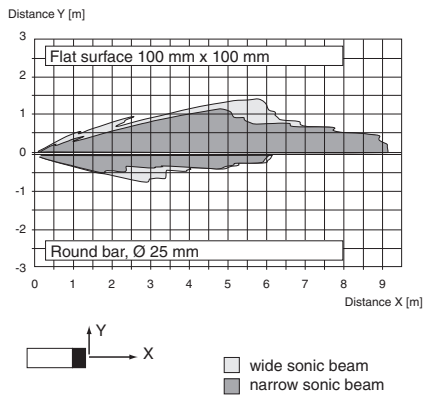

Release date: 2023-02-15 Date of issue: 2023-02-15 Filename: 134006_eng.pdf

Characteristic Curve

Programmable operation modes

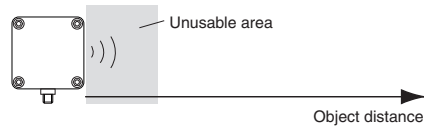

1. Switching point mode

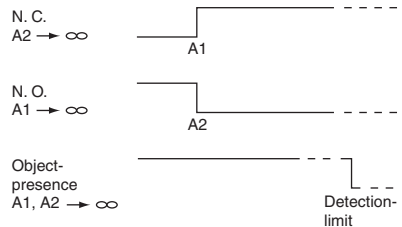

2. Window mode

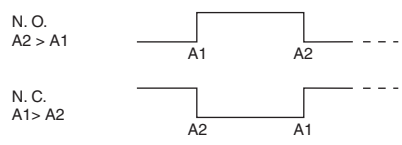



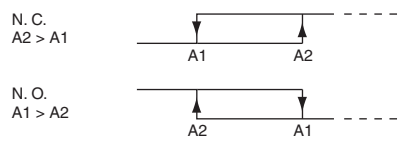

3. Hysteresis mode



Note:
 → ∞ means: cover transducer surface with your hand, while teaching the switching point.
 If A1 = A2, the output works like A2 > A1

Accessories

| | | |
|---|---------------------|---|
|  | MH 04-3505 | Mounting aid for FP and F42 sensors |
|  | MHW 11 | Mounting brackets for sensors |
|  | V15-G-2M-PVC | Female cordset single-ended M12 straight A-coded, 5-pin, PVC cable grey |
|  | V15-W-2M-PUR | Female cordset single-ended M12 angled A-coded, 5-pin, PUR cable grey |

Release date: 2023-02-15 Date of issue: 2023-02-15 Filename: 134006_eng.pdf

Programming

Functional Description

The sensor may be completely parameterised via two keys on the side panel of the housing. As a special feature provided by this sensor, the ultrasound beam width may be adapted to the environmental conditions at the place of operation of the sensor.

Specifying the switching points:

When specifying the switching points, the user determines at which points the switching output changes its state. The order of the switching points $A1 > A2$, or $A1 < A2$ also determines the direction of action (i.e. normally-closed/normally-open contact function).

| Specifying the A1 switching point by pressing the A1 key | |
|--|--|
| Holding down the A1 key > 2 seconds | The sensor switches to learn mode and the user may specify the A1 switching point |
| Positioning the target object at the desired distance | The yellow LED of the sensor flashes fast to indicate that the target object has been recognised. The red LED flashes if the object has not been recognised. |
| Briefly pressing the A1 key | The sensor terminates the specification of the A1 switching point and saves it as a non-volatile value. The specified value is invalid if the object is uncertain (i.e. the red LED lights up at irregular intervals). The learn mode is exited. |

The A2 switching point is specified via the A2 key, analogous to the description above.

Alternatively, the switching points may also be specified electrically via the learn input. To specify the A1 switching point, the learn input must be connected to

$-U_B$; to specify the A2 switching point, it must be connected to $+U_B$. Specified values are saved upon the disconnection from the learn input.

Switching points may only be specified directly after Power on. A time lock secures the adjusted switching points against unintended modification 5 minutes after the last keypress. To modify the switching points later, the user may specify the desired values only after a new Power On.

Proceed as follows to parameterise the output function and the ultrasound beam width:

Press the A1 key during Power on and hold down the key for another second to ensure that the sensor starts the two-step parameterisation of the operating modes.

Step 1, parameterisation of the output function

The output function parameterised last is displayed. All output functions available may be selected via consecutive, brief strokes of the A2 key. These strokes are visualised via short flashes of the green LED.

| Operating mode | Flash sequence of the green LED | A2 key |
|--|---------------------------------|--------|
| 1 switching point/ object detection | | |
| Window function (default) | | |
| Hysteresis mode | | |

Hold down the A1 key for 2 seconds to save the selected output mode, complete the parameterisation and ensure that the sensor returns to normal mode. Step 2 may be initiated by briefly pressing the A1 key (parameterisation of the ultrasound beam width).

Step 2, parameterisation of the ultrasound beam width

In the near range, via Step 2, the ultrasound beam width may be adapted to the requirements of the corresponding application. The beam width parameterised last is displayed first. Available beam width settings may be selected via consecutive, brief strokes of the A2 key. These strokes are visualised via the flash sequence of the red LED.

| Beam width | Flash sequence of the red LED | A2 key |
|-------------|-------------------------------|--------|
| Small beam | | |
| Medium beam | | |
| Large beam | | |

Hold down the A1 key for 2 seconds to save the selected beam shape, complete the parameterisation and ensure that the sensor returns to normal mode. Briefly press the A1 key to return to Step 1 (parameterisation of the output function).

Release date: 2023-02-15 Date of issue: 2023-02-15 Filename: 1344006_eng.pdf

If the parameterisation mode is not terminated within 5 minutes after last keypress (by holding down the A1 key for 2 seconds), the sensor aborts this mode without modifying the settings.

Synchronisation

The sensor has a synchronisation port to suppress mutual influencing. If this port has not been connected, the sensor works at an internally generated cycle rate. Several sensors may be synchronised via the following options.

External synchronisation:

The sensor may be synchronised via the external application of a square wave voltage. A synchronisation pulse on the synchronisation input initiates a measuring cycle. The pulse width must be greater than 100 µs. The measuring cycle is started with the falling edge. A low level > 1 s or an open synchronisation input initiate the transition to normal sensor mode. A high level on the synchronisation input deactivates the sensor.

Two modes are possible:

- Several sensors are controlled via the same synchronisation signal. The sensors work in common mode.
- The synchronisation pulses are forwarded at cyclic intervals to respectively one single sensor. The sensors work in multiplex mode.

Self-synchronisation:

The synchronisation ports of up to 5 sensors suitable for self-synchronisation are connected to each other. These sensors work in multiplex mode after Power on. The On delay increases depending on the number of sensors to be synchronised. While the learn mode is active, no synchronisation is possible (and vice-versa). To specify the switching points, the sensors must be operated in non-synchronised mode.

Note:

If the synchronisation option is not used, the synchronisation input must be connected to ground (0V) or the sensor must be operated with a (4-pole) V1 connecting cable.

Accessories

Mounting aids

MH 04-3505

MHW 11

Cable sockets *)

V15-G-2M-PVC

V15-W-2M-PUR

*) For additional cable sockets see section „Accessories“.