

# RFID read/write device

## IQT1-18GM-R4-V1

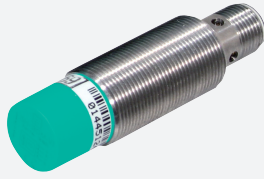

- Operating frequency 13.56 MHz
- Conforms to ISO 15693
- Suitable for FRAM transponder
- Read/write head with thread M18 x 1
- Connection via V1 (M12 x 1) plug connection
- Multihole-LED for function display
- Degree of protection IP67
- Connection via integrated RS-485 interface

HF RFID read/write device, ISO 15693



### Dimensions

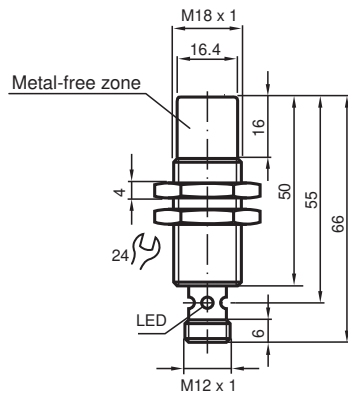

### Technical Data

General specifications	
Operating frequency	13.56 MHz
Transfer rate	26 kBit/s
Sensing range	
Read distance	0 ... 50 mm
Write distance	0 ... 50 mm
Width	max. 45 mm
UL File Number	E87056
MTBF	375 a (Operation at +40 °C)
Indicators/operating means	
LED green/yellow	Multihole-LED: green: power on green flashing: read/write attempt performed yellow: data carrier detected
Electrical specifications	
Rated operating voltage	U <sub>e</sub> 10 ... 30 V DC , ripple 10 % <sub>SS</sub> , limited power source (EN 60950)
Power consumption	P <sub>0</sub> ≤ 1.2 W
Interface	

Release date: 2023-08-08 Date of issue: 2023-08-08 Filename: 265935\_eng.pdf

Refer to "General Notes Relating to Pepperl+Fuchs Product Information".

Pepperl+Fuchs Group  
www.pepperl-fuchs.com

USA: +1 330 486 0001  
fa-info@us.pepperl-fuchs.com

Germany: +49 621 776 1111  
fa-info@de.pepperl-fuchs.com

Singapore: +65 6779 9091  
fa-info@sg.pepperl-fuchs.com

**PF** PEPPERL+FUCHS

## Technical Data

Physical	RS-485 point-to-point connection
Protocol	ASCII
Transfer rate	1200, 2400, 4800, 9600, 19200, 38400 (default) Bit/s
Cable length	≤ 3 m
<b>Directive conformity</b>	
Radio equipment	
Directive 2014/53/EU	EN 301489-1 EN 301489-3 EN 300330 EN 62368-1 EN 50364
RoHS	
Directive 2011/65/EU (RoHS)	IEC/EN 63000
<b>Standard conformity</b>	
Degree of protection	EN 60529
RFID	ISO/IEC 15693-2 ISO/IEC 15693-3 ISO/IEC 18000-3
<b>Ambient conditions</b>	
Ambient temperature	-25 ... 70 °C (-13 ... 158 °F)
Storage temperature	-40 ... 85 °C (-40 ... 185 °F)
<b>Mechanical specifications</b>	
Housing length	66 mm
Housing diameter	18 mm
Degree of protection	IP67
Connection	connector M12 x 1
<b>Material</b>	
Housing	PBT/stainless steel
Encapsulation compound	CY 221/HY 2966
Installation	non-flush
Distance between two heads	≥ 80 mm
Mass	approx. 40 g

## Connection

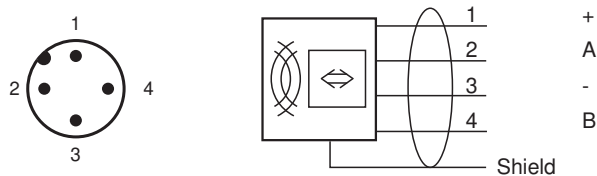

















## Connection

The device may only be operated on a power source with limited power according to EN 60950.

## Factory Setting

Interface transfer rate: 38400 bps  
 Port settings: 8 data bits, no parity, 1 stop bit, no handshake  
 Tag type: 20

## Accessories

	<b>IQC21-8 10pcs</b>	Data carrier
	<b>IQC21-10 10pcs</b>	Data carrier
	<b>IQC21-12.4 10pcs</b>	Data carrier
	<b>IQC21-50F-T10</b>	Data carrier
	<b>IQC21-58</b>	Data carrier
	<b>IQC22-22-T9 50pcs</b>	Data carrier
	<b>IQC33-20 50pcs</b>	Data carrier
	<b>V1-G-2M-PUR-ABG-V1-W</b>	Cordset M12 socket straight to M12 plug angled A-coded, 4-pin, PUR cable grey, shielded
	<b>V1-G-5M-PUR-ABG-V1-W</b>	Cordset M12 socket straight to M12 plug angled A-coded, 4-pin, PUR cable grey, shielded
	<b>V1-G-10M-PUR-ABG-V1-W</b>	Cordset M12 socket straight to M12 plug angled A-coded, 4-pin, PUR cable grey, shielded
	<b>IQC33-50 25pcs</b>	Data carrier
	<b>IQC21-50 25pcs</b>	Data carrier
	<b>IQC33-30 25pcs</b>	Data carrier
	<b>IQC21-30 25pcs</b>	Data carrier
	<b>IQC21-16 50pcs</b>	Data carrier
	<b>IQC21-10</b>	Data carrier

Release date: 2023-08-08 Date of issue: 2023-08-08 Filename: 265935\_eng.pdf

Refer to "General Notes Relating to Pepperl+Fuchs Product Information".

Pepperl+Fuchs Group  
www.pepperl-fuchs.comUSA: +1 330 486 0001  
fa-info@us.pepperl-fuchs.comGermany: +49 621 776 1111  
fa-info@de.pepperl-fuchs.comSingapore: +65 6779 9091  
fa-info@sg.pepperl-fuchs.com **PEPPERL+FUCHS**