



# Ultrasonic sensor

## UB2000-30GM-E4-V15

- Switching output
- 5 different output functions can be set
- Program input
- Synchronization options
- Deactivation option
- Temperature compensation
- Insensitive to compressed air

Single head system



### Dimensions

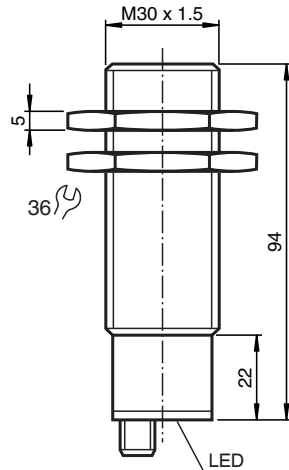

### Technical Data

#### General specifications

Sensing range	80 ... 2000 mm
Adjustment range	120 ... 2000 mm
Dead band	0 ... 80 mm
Standard target plate	100 mm x 100 mm
Transducer frequency	approx. 180 kHz
Response delay	approx. 150 ms

#### Indicators/operating means

LED green	solid: Power-on flashing: program function object detected
-----------	---

Release date: 2023-02-15 Date of issue: 2023-02-15 Filename: 097968\_eng.pdf

Refer to "General Notes Relating to Pepperl+Fuchs Product Information".

Pepperl+Fuchs Group  
www.pepperl-fuchs.com

USA: +1 330 486 0001  
fa-info@us.pepperl-fuchs.com

Germany: +49 621 776 1111  
fa-info@de.pepperl-fuchs.com

Singapore: +65 6779 9091  
fa-info@sg.pepperl-fuchs.com

**PF** PEPPERL+FUCHS

## Technical Data

LED yellow		solid: switching state switch output flashing: program function
LED red		normal operation: "fault" program function: no object detected
<b>Electrical specifications</b>		
Operating voltage	$U_B$	10 ... 30 V DC , ripple 10 % <sub>SS</sub>
No-load supply current	$I_0$	≤ 50 mA
<b>Input/Output</b>		
Synchronization		bi-directional 0 level: $-U_B \dots +1$ V 1 level: $+4$ V $\dots +U_B$ input impedance: > 12 KOhm synchronization pulse: ≥ 100 μs, synchronization interpulse period: ≥ 2 ms
Synchronization frequency		
Common mode operation		max. 30 Hz
Multiplex operation		≤ 30 Hz / n , n = number of sensors , n ≤ 5
<b>Input</b>		
Input type		1 program input, operating range 1: $-U_B \dots +1$ V, operating range 2: $+4$ V $\dots +U_B$ input impedance: > 4.7 kΩ; program pulse: ≥ 1 s
<b>Output</b>		
Output type		1 switch output NPN , Normally open/closed , programmable
Rated operating current	$I_e$	200 mA , short-circuit/overload protected
Voltage drop	$U_d$	≤ 2.5 V
Repeat accuracy		≤ 0.5 % of switching point
Switching frequency	f	≤ 3.3 Hz
Range hysteresis	H	1 % of the set operating distance
Temperature influence		< 2 % of far switch point
<b>Compliance with standards and directives</b>		
Standard conformity		
Standards		EN IEC 60947-5-2:2020 IEC 60947-5-2:2019
<b>Approvals and certificates</b>		
UL approval		cULus Listed, General Purpose
CCC approval		CCC approval / marking not required for products rated ≤36 V
<b>Ambient conditions</b>		
Ambient temperature		-25 ... 70 °C (-13 ... 158 °F)
Storage temperature		-40 ... 85 °C (-40 ... 185 °F)
<b>Mechanical specifications</b>		
Connection type		Connector plug M12 x 1 , 5-pin
Housing diameter		30 mm
Degree of protection		IP65
Material		
Housing		nickel plated brass; plastic components: PBT
Transducer		epoxy resin/hollow glass sphere mixture; polyurethane foam
Mass		140 g
<b>Factory settings</b>		
Output		Switch point A1: 220 mm Switch point A2: 2100 mm output function: Window mode output behavior: NO contact

## Connection

**Standard symbol/Connections:**  
(version E4, npn)

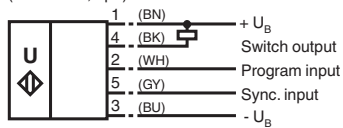

Wire colors in accordance with EN 60947-5-2.

## Connection Assignment

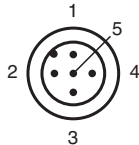

Wire colors in accordance with EN 60947-5-2

1	BN	(brown)
2	WH	(white)
3	BU	(blue)
4	BK	(black)
5	GY	(gray)

## Characteristic Curve

### Characteristic response curve

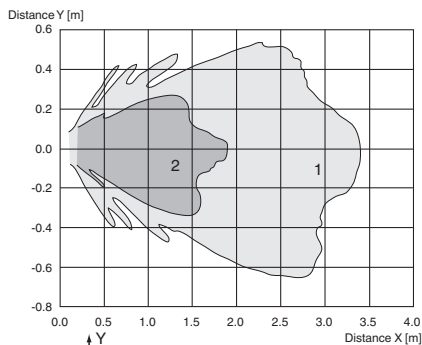

Curve 1: flat surface 100 mm x 100 mm  
Curve 2: round bar, Ø 25 mm







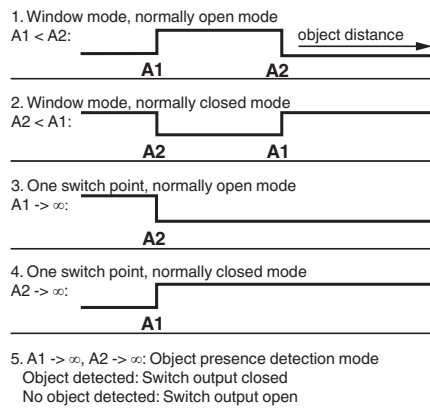

Release date: 2023-02-15 Date of issue: 2023-02-15 Filename: 097968\_eng.pdf

## Characteristic Curve

### Programmable output modes



## Accessories

	<b>BF 30</b>	Mounting flange, 30 mm
	<b>BF 30-F</b>	Plastic mounting adapter, 30 mm
	<b>BF 5-30</b>	Universal mounting bracket for cylindrical sensors with a diameter of 5 ... 30 mm
	<b>UB-PROG2</b>	Programming unit
	<b>UVW90-M30</b>	Ultrasonic -deflector
	<b>UVW90-K30</b>	Ultrasonic -deflector
	<b>M30K-VE</b>	Plastic nuts with centering ring for the vibration-free mounting of cylindrical sensors
	<b>V15-G-2M-PVC</b>	Female cordset single-ended M12 straight A-coded, 5-pin, PVC cable grey
	<b>V15-W-2M-PUR</b>	Female cordset single-ended M12 angled A-coded, 5-pin, PUR cable grey

Release date: 2023-02-15 Date of issue: 2023-02-15 Filename: 097968\_eng.pdf

## Programming

### Programming procedure

The sensor features a programmable switch output with two programmable switch points. Programming the switch points and the operating mode is done by applying the supply voltage  $-U_B$  or  $+U_B$  to the Teach-In input. The supply voltage must be applied to the Teach-In input for at least 1 s. LEDs indicate whether the sensor has recognized the target during the programming procedure.

**Note:**

If a programming adapter UB-PROG2 is used for the programming procedure, button A1 is assigned to  $-U_B$  and button A2 is assigned to  $+U_B$ .

### Programming of the switch output

#### Window Modes

##### Normally open (NO) output

1. Place the target at the near end of the desired switch window
2. Program the window boundary by applying  $-U_B$  to the Teach-In input (yellow and green LEDs flash)
3. Disconnect the Teach-In input from  $-U_B$  to save the window boundary
4. Place the target at the far end of the desired switch window
5. Program the window boundary by applying  $+U_B$  to the Teach-In input (yellow and green LEDs flash)
6. Disconnect the Teach-In input from  $+U_B$  to save the window boundary

##### Normally closed (NC) output

1. Place the target at the near end of the desired switch window
2. Program the window boundary by applying  $+U_B$  to the Teach-In input (yellow and green LEDs flash)
3. Disconnect the Teach-In input from  $+U_B$  to save the window boundary
4. Place the target at the far end of the desired switch window
5. Program the window boundary by applying  $-U_B$  to the Teach-In input (yellow and green LEDs flash)
6. Disconnect the Teach-In input from  $-U_B$  to save the window boundary

#### Switch Point Modes

##### Normally open (NO) output

1. Place the target at the desired switch point position
2. Program the switch point by applying  $+U_B$  to the Teach-In input (yellow and green LEDs flash)
3. Disconnect the Teach-In input from  $+U_B$  to save the switch point
4. Cover the sensor face with hand or remove all objects from sensing range
5. Program the switch point by applying  $-U_B$  to the Teach-In input (red and yellow LEDs flash)
6. Disconnect the Teach-In input from  $-U_B$  to save the switch point

##### Normally closed (NC) output

1. Place the target at the desired switch point position
2. Program the switch point by applying  $-U_B$  to the Teach-In input (yellow and green LEDs flash)
3. Disconnect the Teach-In input from  $-U_B$  to save the switch point
4. Cover the sensor face with hand or remove all objects from sensing range
5. Program the switch point by applying  $+U_B$  to the Teach-In input (red and yellow LEDs flash)
6. Disconnect the Teach-In input from  $+U_B$  to save the switch point

#### Object Detection Mode

1. Cover the sensor face with hand or remove all objects from sensing range
2. Apply  $-U_B$  to the Teach-In input (red and yellow LEDs flash)
3. Disconnect the Teach-In input from  $+U_B$  to save the setting
4. Apply  $+U_B$  to the Teach-In input (red and yellow LEDs flash)
5. Disconnect the Teach-In input from  $+U_B$  to save the setting

## Factory Setting

### Factory settings

See technical data.

## Indication

The sensor provides LEDs to indicate various conditions.

	green LED	red LED	yellow LED
During normal operation			
Proper operation	On	Off	Switching state
Interference (e. g. compressed air)	Off	Flashing	Previous state

Release date: 2023-02-15 Date of issue: 2023-02-15 Filename: 097968\_eng.pdf

Refer to "General Notes Relating to Pepperl+Fuchs Product Information".

During sensor programming	Flashing	Off	Flashing
Object detected	Off	Flashing	Flashing
No object detected	Off	Flashing	Flashing
Object uncertain (programming invalid)	Off	Flashing	Flashing

## Commissioning

### Synchronization

This sensor features a synchronization input for suppressing ultrasonic mutual interference ("cross talk"). If this input is not connected, the sensor will operate using internally generated clock pulses. It can be synchronized by applying an external square wave. The pulse duration must be  $\geq 100 \mu s$ . Each falling edge of the synchronization pulse triggers transmission of a single ultrasonic pulse. If the synchronization signal remains low for  $\geq 1$  second, the sensor will revert to normal operating mode. Normal operating mode can also be activated by opening the signal connection to the synchronization input (see note below).

If the synchronization input goes to a high level for  $> 1$  second, the sensor will switch to standby mode, indicated by the green LED. In this mode, the outputs will remain in the last valid output state.

**Note:**

If the option for synchronization is not used, the synchronization input has to be connected to ground (0 V) or the sensor must be operated via a V1 cordset (4-pin).

The synchronization function cannot be activated during programming mode and vice versa.

**The following synchronization modes are possible:**

1. Several sensors (max. number see technical data) can be synchronized together by interconnecting their respective synchronization inputs. In this case, each sensor alternately transmits ultrasonic pulses in a self multiplexing mode. No two sensors will transmit pulses at the same time (see note below).
2. Multiple sensors can be controlled by the same external synchronization signal. In this mode the sensors are triggered in parallel and are synchronized by a common external synchronization pulse.
3. A separate synchronization pulse can be sent to each individual sensor. In this mode the sensors operate in external multiplex mode (see note below).
4. A high level ( $+U_B$ ) on the synchronization input switches the sensor to standby mode.

**Note:**

Sensor response times will increase proportionally to the number of sensors that are in the synchronization string. This is a result of the multiplexing of the ultrasonic transmit and receive signal and the resulting increase in the measurement cycle time.

## Installation Conditions

If the sensor is installed in an environment where the temperature can fall below  $0 \text{ }^\circ\text{C}$ , one of these mounting flanges must be used for mounting: BF30, BF30-F, or BF 5-30.

If it is intended to operate the sensor at  $- 25 \text{ }^\circ\text{C}$ , we recommend discussing the mounting situation with a Pepperl + Fuchs application specialist to ensure a trouble-free operation.

If the sensor is mounted in a through hole using the included steel nuts, it must be mounted at the middle of the threaded housing. If it must be mounted at the front end of the threaded housing, plastic nuts with centering ring (optional accessories) must be used.

Release date: 2023-02-15 Date of issue: 2023-02-15 Filename: 097988\_eng.pdf