

AS-Interface I/O module

VBA-4E3A-G20-ZEL/M1L-P6



- A/B node with extended addressing possibility for up to 62 nodes
- Inputs for 3-wire sensors
- Outputs for DC roller motors (drum motors)
- Connection of motors and sensors via M8 connectors
- Configurable start/stop ramps
- Communication monitoring
- Power supply of the inputs and outputs from the external auxiliary voltage
- Function display for bus, external auxiliary voltage, in- and outputs
- Cable piercing method with gold plated contact pins

G20 motor control module for Interroll EC310, Interroll EC5000 24V AI, Rulmeca BL3, Itoh Denki PM500XK, Itoh Denki PM500XC



Function

The AS-Interface connecting module is a field module with two sensor inputs and two electronic outputs for controlling DC roller motors of the type Interroll EC310 and Rulmeca BL3 or compatible.

The compact housing can be installed directly in support profiles or conduits.

The connection to the AS-Interface network and power supply is made using the AS-Interface flat cable and insulation-piercing technology. The pivoted flat cable guide is secured using a snap fit. No tools are required. The sensor inputs and motor outputs are connected via cable outputs with M8 round plug connectors (inputs 4-pole female cordset with knurled thumb screw, outputs 5-pole snap-on female cordset). Power for the inputs and motors is provided by the external auxiliary voltage UAUX.

The current switching state of the sensor inputs is indicated by the IN LEDs. The FUSE LEDs show that the power supply is applied to both motors. The MOT LEDs indicate when the motors are in operation (stop/operation). The DIR LED indicates the status of the rotation signal. The activation of the fault signal by a motor is displayed with the ERR LEDs.

The motors can be switched on and off individually by means of AS-Interface databits D0 and D1. D2 controls the rotation signal. The AS-Interface parameters P0 ... P2 select the voltage for the speed signal. The rotation and speed apply to both motors.

A start/stop ramp can be set for the speed signal for the controlled acceleration and stopping of the motors. The ramp duration can be selected from eight default values and can be configured over a defined sequence of data and parameters. The ramp selected in this way is saved permanently and is activated automatically after each power-on. The number of the ramp is displayed by a short flash of the ERR2, IN1, and IN2 LEDs in binary code. If the ramp number is set as 0 (no ramp), the six LEDs MOT1 to IN2 flash to show this.

The ramp is not effective if the rotation signal is switched while the motor is running. In other words, the reversal of rotation direction occurs immediately.

Note:

The communication monitor of the module deactivates the outputs if there is no communication between the AS-Interface and the module for more than 40 ms.

The IN1 and IN2 inputs suppress impulses of less than 2 ms.

A signal indicating an overload of the input supply or the absence of the external auxiliary voltage is also transmitted to the AS-Interface master via the "peripheral fault" function. Communication via the AS-Interface continues.

Dimensions

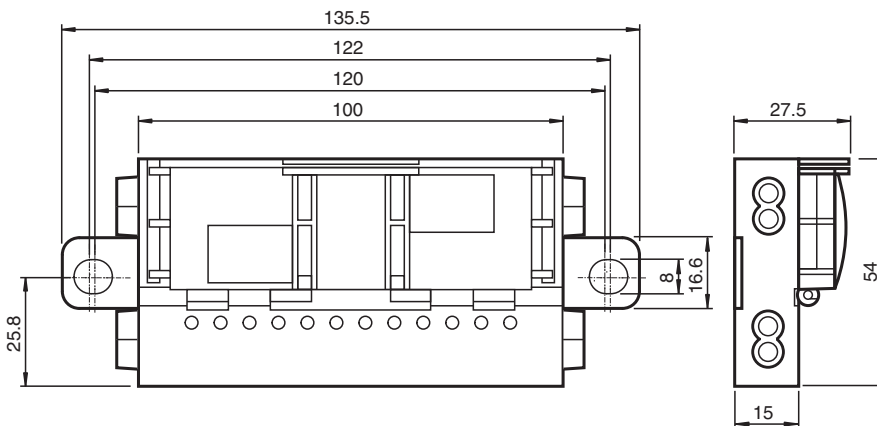

Release date: 2023-07-13 Date of issue: 2023-07-13 Filename: 70135193_eng.pdf

Refer to "General Notes Relating to Pepperl+Fuchs Product Information".

Pepperl+Fuchs Group
www.pepperl-fuchs.com

USA: +1 330 486 0001
fa-info@us.pepperl-fuchs.com

Germany: +49 621 776 1111
fa-info@de.pepperl-fuchs.com

Singapore: +65 6779 9091
fa-info@sg.pepperl-fuchs.com

PEPPERL+FUCHS

Technical Data

General specifications		
Node type		A/B node
AS-Interface specification		V3.0
Required gateway specification		≥ V2.1
Profile		S-7.A.E
IO code		7
ID code		A
ID1 code		6
ID2 code		E
UL File Number		E223772 "For use in NFPA 79 Applications only"
MTBF		98 a
Compatible roller motors		Interroll EC310, Interroll EC5000 24V AI (20W / 35W / 50W), Rulmeca BL3, Itoh Denki PM500XK, Itoh Denki PM500XC
Indicators/operating means		
LED FAULT		error display; LED red red: communication error or address is 0 red flashing: overload of sensor supply or external auxiliary voltage U_{AUX} missing
LED ERR		Motor fault: 2 LED yellow
LED PWR		AS-Interface voltage; green LED green: voltage OK green flashing: address 0 or sensor supply overload or external auxiliary voltage U_{AUX} missing
LED AUX		ext. auxiliary voltage U_{AUX} ; dual LED green/red green: voltage OK red: reverse voltage
LED IN		switching state (input); 2 LED yellow
LED FUSE		Motor power supply; 2 green LEDs
LED DIR		Motor rotation direction; yellow LED
LED MOT		Motor active; 2 yellow LEDs
Electrical specifications		
Auxiliary voltage (output)	U_{AUX}	18 ... 30 VDC PELV
Rated operating voltage	U_e	26.5 ... 31.6 V from AS-Interface
Rated operating current	I_e	≤ 35 mA
Input		
Number/Type		2 Inputs for 3-wire sensors (PNP), DC
Supply		from external auxiliary voltage U_{AUX}
Current loading capacity		500 mA , overload and short-circuit protected
Input current		≤ 8 mA (limited internally)
Switching point		according to DIN EN 61131-2 0 (undamped) ≤ 0.5 mA 1 (damped) ≥ 2.0 mA
Signal delay		< 1 ms (input/AS-Interface)
Input filter		2 ms
Output		
Number/Type		2 outputs for DC roller motors (MOT1, MOT2)
Supply		from external auxiliary voltage U_{AUX}
Current		3.5 A continuous current , 5 A (<2 s) , max. 7.5 A (<0,3 s) per motor
Overload protection		Fuse 5 A, $I^2t = 53.7 A^2s$ per motor
Velocity signal	U_S	1.4 ... 13 V at no-load $R_i = 5.6 k\Omega$, $R_{LOAD} \geq 35 k\Omega$ Control via parameter P2:0
Rotation direction signal	U_D	Off / ≥ ($U_{AUX} - 1.0 V$) at no-load $R_i = 5.6 k\Omega$, $R_{LOAD} \geq 5 k\Omega$ AS-Interface data bit D2 = 0: $U_D =$ Off
Motor fault		Digital input NPN, $U_0 = 3.3 V$, $R_i = 52 k\Omega$ 0 (no error) ≥ 40 μA 1 (error) ≤ 30 μA
Directive conformity		
Electromagnetic compatibility		

Release date: 2023-07-13 Date of issue: 2023-07-13 Filename: 70135193_eng.pdf

Refer to "General Notes Relating to Pepperl+Fuchs Product Information".

 Pepperl+Fuchs Group
www.pepperl-fuchs.com

 USA: +1 330 486 0001
fa-info@us.pepperl-fuchs.com

 Germany: +49 621 776 1111
fa-info@de.pepperl-fuchs.com

 Singapore: +65 6779 9091
fa-info@sg.pepperl-fuchs.com

 **PEPPERL+FUCHS**

Technical Data

Directive 2014/30/EU	EN 62026-2:2013
Standard conformity	
Degree of protection	EN 60529:2000
Fieldbus standard	EN 62026-2:2013
Input	EN 61131-2:2007
Emitted interference	EN 61000-6-4:2007
AS-Interface	EN 62026-2:2013
Noise immunity	EN 61000-6-2:2005, EN 61326-1:2006, EN 62026-2:2013
Ambient conditions	
Ambient temperature	-25 ... 60 °C (-13 ... 140 °F)
Storage temperature	-30 ... 85 °C (-22 ... 185 °F)
Mechanical specifications	
Degree of protection	IP54 according to EN 60529
Connection	AS-Interface, AUX: Insulation piercing technology Yellow flat cable/black flat cable Inputs/outputs: M8 round plug connector in accordance with EN 61076-2-104 Inputs: LF004-GS1-A (4-pin, bushing contacts, screw lock, A-coded) Matching connector: LM004-Gx1-A or similar Outputs: NF005-SS1-B (5-pin, bushing contacts, snap lock, B-coded). Matching connector: NM005-Sx1-B or similar
Mass	220 g
Mounting	2 clips with Ø 8 mm drill hole
Cable length	0.35 m
Note	The flat cable routing is designed for 100 actuation cycles

Connection

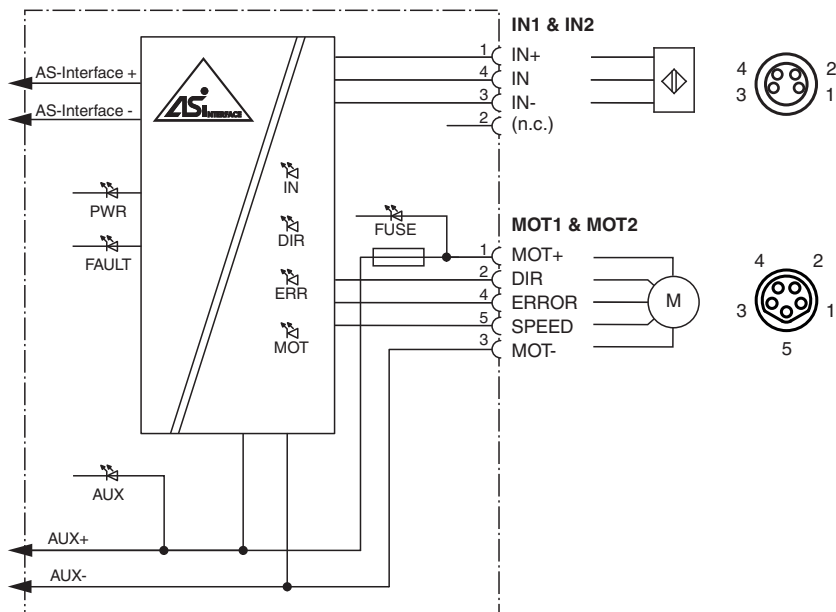

Release date: 2023-07-13 Date of issue: 2023-07-13 Filename: 70135193_eng.pdf

Assembly

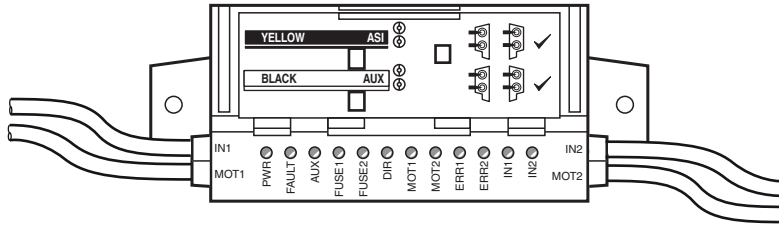

Programming

Data bits

(function via AS-Interface)

Data bits	Input	Output
D0	MOT1 fault	MOT1 operation
D1	MOT2 fault	MOT2 operation
D2	IN1	MOT1/MOT2 direction of rotation
D3	IN2	-

Parameter bit

(programmable via AS-Interface)

P2	P1	P0	D0/D1	Speed signal U_s
x	x	x	0	< 1.5 V
0	0	0	1	3.96 V (3.92 ... 4.00 V)
0	0	1	1	4.78 V (4.73 ... 4.83 V)
0	1	0	1	5.61 V (5.55 ... 5.67 V)
0	1	1	1	6.44 V (6.38 ... 6.50 V)
1	0	0	1	8.50 V (8.42 ... 8.59 V)
1	0	1	1	9.63 V (9.53 ... 9.73 V)
1	1	0	1	10.00 V (9.90 ... 10.10 V)
1	1	1	1	7.26 V (7.19 ... 7.33 V), default setting

Start/Stop ramp

8 ramps can be configured by AS-Interface parameters/data sequence.

Incline

Constant, independent of terminal velocity.

The ramp duration defines the time from stationary to max. speed ($U_s = 10$ V) or from max. speed to stationary. When the terminal velocity is lower, the ramp duration is shorter.

Display

Current ramp nos. 1 ... 7 in binary form through the flashing of the ERR2 (MSB), IN1, and IN2 (LSB) LEDs after power on. In the case of ramp number 0 (no ramp), the 6 MOT1 ... IN2 LEDs flash.

Ramp no.	Ramp duration
0	No Ramp; default setting
1	50 ms
2	100 ms
3	200 ms
4	300 ms
5	500 ms
6	1000 ms
7	1500 ms

Ramp configuration

Non-volatile

Time frame

10 s after setting D-OUT=4

Hold time

Data/parameters: 10 ms per step

Display

Configuration mode activated: 6 LEDs MOT1 ... IN2 flash

Step	P2:0	D3:0-OUT	D3:0-IN	Comment
1	3	4	x	

Programming

Step	P2:0	D3:0-OUT	D3:0-IN	Comment
2	1	4	x	
3	6	4	x	
4	3	4	x	
5	1	4	x	
6	6	4	C	Configuration mode activated
7	6	Ramp no.	C	Ramp no. 0 ... 7 (see above)
8	4	Ramp no.	A	Ramp no. stored in non-volatile memory
9	7	0	x	Normal operation







Troubleshooting

If an error occurs in the defined sequence of parameter or data values during steps 1 to 6, the module remains in normal operation.

If an error occurs in steps 7 or 8, the module outputs the value D-IN = E and waits until P = 7 and D-OUT = 0 is set before it returns to normal operation.

If P = 7 and D-OUT = 0 is already set in step 7 or 8, the module switches to normal operation immediately without the output D-IN = E. The stored ramp is not changed.

Accessories

	VBP-HH1-V3.0-KIT	AS-Interface Handheld with accessory
	VAZ-PK/G20-1M-V1-G	Adapter cable G20 module/hand-held programming device
	VAZ-G20-MH	Mounting aid
	VAZ-G10-LIMITER	Voltage limiter G10
	V311-GR-BK1M-PUR-U-V311-GR	Cordset M8 socket snap-lock straight to M8 plug snap-lock straight B-coded, 5-pin, PUR cable black, UL-approved, drag chain suitable, torsion resistant
	V311-GR-BK2M-PUR-U-V311-GR	Cordset M8 socket snap-lock straight to M8 plug snap-lock straight B-coded, 5-pin, PUR cable black, UL-approved, drag chain suitable, torsion resistant