



Adapter cable

V15-W-0,1M-PUR-ABG-V35-G

- Degree of protection IP67
- Halogen-free
- Knurled nut suitable for tool assembly
- Immunity to vibration, with mechanical latching
- Metal housing
- EMC shielded

Adapter cable M12 socket angled A-coded 5-pin to M9 plug straight metal housing 5-pin, PUR cable grey, shielded



Dimensions

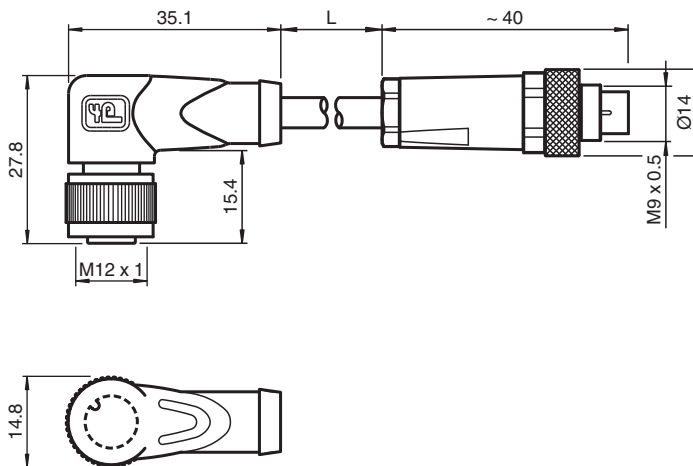

Technical Data

General specifications

Connector 1	
Connection	socket
Construction type	M12
Style	angled
Locking	screw connection
Number of pins	5
Coding	A-coded
Connector 2	
Connection	plug
Construction type	M9
Style	straight
Locking	screw connection
Number of pins	5
Customization	Metal housing
Electrical specifications	

Release date: 2023-07-12 Date of issue: 2023-07-13 Filename: 238762_eng.pdf

Refer to "General Notes Relating to Pepperl+Fuchs Product Information".

Pepperl+Fuchs Group
www.pepperl-fuchs.com

USA: +1 330 486 0001
fa-info@us.pepperl-fuchs.com

Germany: +49 621 776 1111
fa-info@de.pepperl-fuchs.com

Singapore: +65 6779 9091
fa-info@sg.pepperl-fuchs.com

PEPPERL+FUCHS

Technical Data

Operating voltage	U _B	max. 48 V AC / 60 V DC
Operating current	I _B	max. 3 A
Volume resistance		< 5 mΩ
Conformity		
Degree of protection		EN 60529
Plug connection		connector M12 x 1 : IEC 61076-2-101
Halogen-free		DIN VDE 0472-815 DIN EN 50267-2-1
Ambient conditions		
Ambient temperature		
Connector 1		-40 ... 90 °C (-40 ... 194 °F)
Connector 2		-40 ... 85 °C (-40 ... 185 °F)
Cable, fixed		-40 ... 80 °C (-40 ... 176 °F)
Cable, flexing		-25 ... 80 °C (-13 ... 176 °F)
Pollution degree		3
Mechanical specifications		
Connector 1		
Tightening torque		0.6 Nm
Loosening protection		available
Tool installation		straight knurling
Mating cycles		min. 100
Shielding		shield connected to screw connection
Degree of protection		IP67 / IP68 / IP69
Connector 2		
Mating cycles		min. 500
Shielding		shield connected to connector
Degree of protection		IP67
Cable		
Sheath diameter		4.8 mm
Bending radius		> 10 x cable diameter, moving > 5 x cable diameter, fixed
Sheath stripping force		max. 100 N / 300 mm
Sheath color		grey (similar to RAL 7001)
Number of cores		5
Core cross section		0.34 mm ²
Cores color		Core 1-5: brown Core 2-2: white Core 3-1: blue Core 4-3: black Core 5-4: grey
Core construction		42 x 0.1 mm Ø
Shield		tinned copper braiding, 85 % coverage
Length	L	0.1 m
Cable code		Li 9Y 11YM 5 x 0.34
Material		
Halogen-free		yes
Connector 1		
Screw connection		Zinc diecast, nickel-plated
Body		TPU, black
Contact surface		Au
Flammability		V-2
Connector 2		
Screw connection		brass, nickel-plated
Body		brass nickel-plated
Contact surface		Au

Release date: 2023-07-12 Date of issue: 2023-07-13 Filename: 238762_eng.pdf

Refer to "General Notes Relating to Pepperl+Fuchs Product Information".

Pepperl+Fuchs Group
www.pepperl-fuchs.comUSA: +1 330 486 0001
fa-info@us.pepperl-fuchs.comGermany: +49 621 776 1111
fa-info@de.pepperl-fuchs.comSingapore: +65 6779 9091
fa-info@sg.pepperl-fuchs.com

PEPPERL+FUCHS





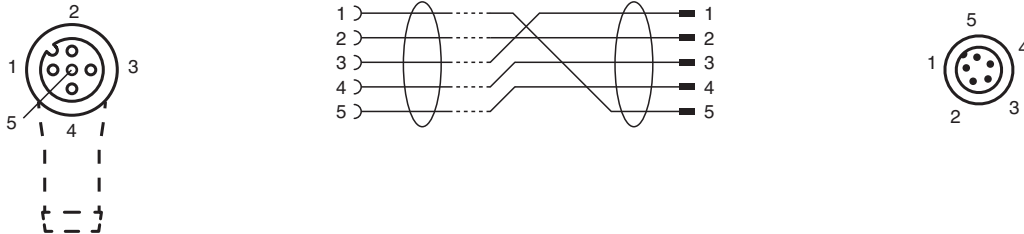

Technical Data

Cable	
Sheathing	PUR based on polyether
Core insulation	PP
Chemical resistance	good

Connection



Accessories

	MH V1-SCREWDRIVER	Torque screwdriver (0.6 Nm)
	MH V1-BIT M12	plug-in cap M12
	V1/V3-LABELHOLDER	Label holder
	V1/V3-LABEL	Label plate
	MH V1-Holder	Modular universal holder for M12 connectors
	V1-CLIP	Unlocking protector for M12 connector
	V1-MARKING-RING-COLOR	Marking rings for M12 connectors, various colors

Release date: 2023-07-12 Date of issue: 2023-07-13 Filename: 238762_eng.pdf