

Inductive positioning system

PMI14V-F112-2EPE2-IO

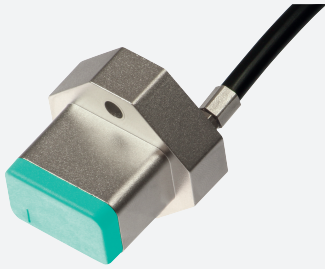

- Parameterization and diagnosis via IO-Link
- 3 configurable switching frames
- Measuring range 0 ... 14 mm
- Shielded line 2 m



IO-Link

Dimensions

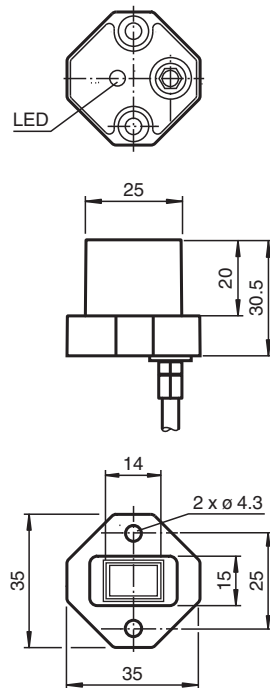

Technical Data

General specifications

Installation	flush
Object distance	max. 2.5 mm
Measurement range	0 ... 14 mm

Nominal ratings

Operating voltage	U_B	10 ... 30 V
Reverse polarity protection		reverse polarity protected
Linearity error		± 0.3 mm
Repeat accuracy	R	± 0.05 mm
Resolution		33 μ m

Release date: 2022-05-17 Date of issue: 2022-05-17 Filename: 263758_eng.pdf

Refer to "General Notes Relating to Pepperl+Fuchs Product Information".

Pepperl+Fuchs Group
www.pepperl-fuchs.com

USA: +1 330 486 0001
fa-info@us.pepperl-fuchs.com

Germany: +49 621 776 1111
fa-info@de.pepperl-fuchs.com

Singapore: +65 6779 9091
fa-info@sg.pepperl-fuchs.com

PEPPERL+FUCHS

Technical Data

Temperature drift		± 0.5 mm
No-load supply current	I_0	≤ 20 mA
Operating voltage indicator		LED green
Functional safety related parameters		
MTTF _d		490 a
Mission Time (T _M)		20 a
Diagnostic Coverage (DC)		0 %
Interface		
Interface type		IO-Link
Mode		COM2 (38.4 kBaud)
Value range		0000h ... 7000h
Switching output		
Output type		2 Push-pull (4 in 1) outputs , 1 switch output PNP , short-circuit protected , reverse polarity protected , overvoltage protected , programmable
Operating current	I_L	≤ 100 mA / Output
Switching hysteresis		3-step, adjustable 0.2 m ... 0.8 mm
Voltage drop		≤ 3 V
Short-circuit protection		pulsing
Compliance with standards and directives		
Standard conformity		
Standards		EN 60947-5-2:2007 EN 60947-5-2/A1:2012 IEC 60947-5-2:2007 IEC 60947-5-2 AMD 1:2012 IEC 61131-9:2013
Approvals and certificates		
UL approval		cULus Listed, Class 2 Power Source, Type 1 enclosure
CCC approval		CCC approval / marking not required for products rated ≤36 V
Ambient conditions		
Ambient temperature		-25 ... 70 °C (-13 ... 158 °F)
Mechanical specifications		
Connection type		2 m PUR cable , screened
Housing material		diecast zinc, not laquered or coated
Degree of protection		IP67
Material		
Target		mild steel, e. g. 1.0037, SR235JR (formerly St37-2)
Cable		
Cable diameter		4.8 mm
Bending radius		> 10 x cable diameter
Note		The data relating to accuracy only apply to a distance to the object to be detected of 1 ... 2.5 mm.

Connection

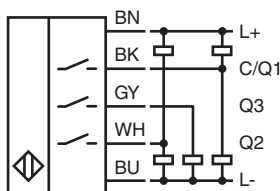

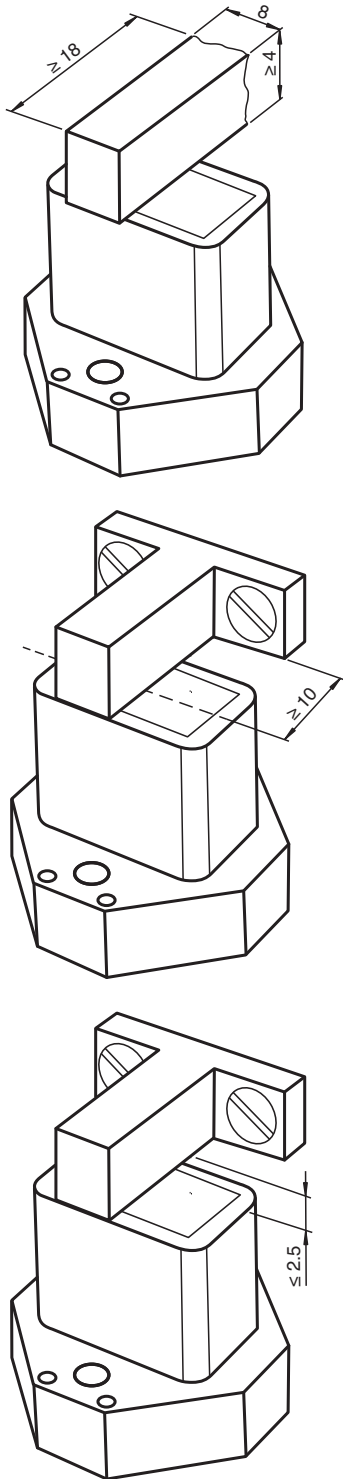

Release date: 2022-05-17 Date of issue: 2022-05-17 Filename: 263758_eng.pdf

Installation Conditions











Release date: 2022-05-17 Date of issue: 2022-05-17 Filename: 263758_eng.pdf

Accessories

	BT-F90-W	Damping element for sensors of type F90, F112, and F166; side hole
	BT-F90-G	Damping element for sensors of type F90, F112, and F166; front hole
	ICE2-8IOL-G65L-V1D	EtherNet/IP IO-Link master with 8 inputs/outputs

Refer to "General Notes Relating to Pepperl+Fuchs Product Information".

Accessories

	ICE3-8IOL-G65L-V1D	PROFINET IO IO-Link master with 8 inputs/outputs
	ICE1-8IOL-G30L-V1D	Ethernet IO-Link module with 8 inputs/outputs
	ICE1-8IOL-G60L-V1D	Ethernet IO-Link module with 8 inputs/outputs
	ICE2-8IOL-K45P-RJ45	EtherNet/IP IO-Link master with 8 inputs/outputs, DIN rail, push-in connectors
	ICE2-8IOL-K45S-RJ45	EtherNet/IP IO-Link master with 8 inputs/outputs, DIN rail, screw terminal
	ICE3-8IOL-K45P-RJ45	PROFINET IO IO-Link master with 8 inputs/outputs, DIN rail, push-in terminals
	ICE3-8IOL-K45S-RJ45	PROFINET IO IO-Link master with 8 inputs/outputs, DIN rail, screw terminal
	IO-Link-Master02-USB	IO-Link master, supply via USB port or separate power supply, LED indicators, M12 plug for sensor connection

Function

Description of Sensor Functions

Additional Functions and Parameters (IO-Link)

Additional functions	Sensor temperature indicator Measuring range overrun and underrun indicator
Measuring range	Scalable measuring range Invertible measuring range
Switching outputs	Switching point can be parameterized/taught in Switching window can be parameterized/taught in Switching hysteresis can be parameterized Invertible switching output
	Selectable output type (high or low switched)

Installation

Information on Installation and Operation

Safety Information



Warnung

This product must not be used in applications in which the safety of persons depends on the function of the device. This product is not a safety component as specified in the EU Machinery Directive.

Actuator

The linear position measurement system is optimally aligned to the geometry of Pepperl+Fuchs actuators.

Using Your Own Actuators

Generally speaking, it is possible for you to use your own actuators. The specified measurement accuracy of the sensor will be achieved only if the actuator has the following properties:

- Material: construction steel such as S235JR+AR (previously St37)
- Dimensions (L x W x H): $\geq 18 \text{ mm} \times 8 \text{ mm} \times \geq 4 \text{ mm}$
- The active surface of the actuator must protrude across the entire sensor width.

Note:

The width of the actuator must be precisely 8 mm. If the width of the actuator deviates from this value, the position values will differ.

Installation

- It is possible to flush mount the device.
- The distance between the center of the measurement field (framed area on the front panel of the sensor) and the fixing base or fixing elements (e.g., protruding screw heads) of the actuator must be at least 10 mm.

Operating Instructions

The specified measurement accuracy is achieved if the distance of the actuator from the sensor surface is max. 2.5 mm.

Definition of the Measuring Range/Measured Position

The measured position of the actuator is based on half of the width (center of the actuator).

The measuring range starts and ends when the actuator covers the measurement field marked on the sensor with half of its width in the course of its longitudinal movement.

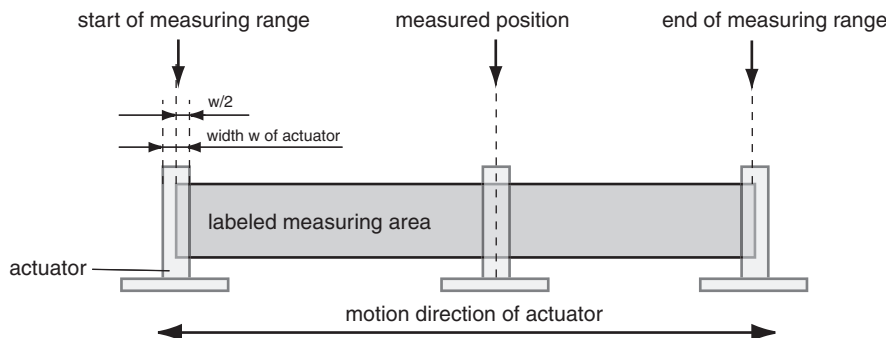

Release date: 2022-05-17 Date of issue: 2022-05-17 Filename: 263758_eng.pdf

Refer to "General Notes Relating to Pepperl+Fuchs Product Information".

Parameterization

Supported IO-Link device parameters

Index	Subindex	Name
Smart sensor profile parameters		
0x3A		Teach-In Channel
0x3B		Teach-In Status
0x3C	1, 2	BD1_SPV, Switching signal 1
0x3D	1, 2, 3	BD1_SPV, Switching signal 1 configuration
0x3E	1, 2	BD2_SPV, Switching signal 2
0x3F	1, 2, 3	BD2_SPV, Switching signal 2 configuration
0x4000	1, 2	BD3_SPV, Switching signal 3
0x4001	1, 2, 3	BD3_SPV, Switching signal 3 configuration
Device specific operation parameters		
0x40	1, 2, 3	Centered Window Width
0x42	1, 2	AD_SPC, Analog signal setpoint value
0x43	1, 2, 3	AD_SPC, Analog signal configuration
0x5F	1, 2, 3, 4, 5	Measurement data collection
Standard operation control		
0x70	1, 2, 3, 4, 5, 6, 7, 8	Output configuration
0x74		Event configuration
0x7F		Locator indication control
User information		
0xC0		UT1, User tag 1
0xC1		UT2, User tag 2
Special function		
0xE2		Operating temperature
0xE8	1, 2	Device characteristics

Details of the listed device parameters can be found in the manual.