



Ultrasonic sensor

UB1000-18GM75-E01-V15

- 2 switch outputs
- Selectable sound lobe width
- Program input
- Temperature compensation
- Very small unusable area

Single head system



Dimensions

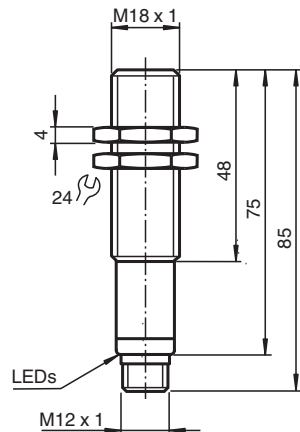

Technical Data

General specifications	
Sensing range	70 ... 1000 mm
Adjustment range	90 ... 1000 mm
Dead band	0 ... 70 mm
Standard target plate	100 mm x 100 mm
Transducer frequency	approx. 255 kHz
Response delay	approx. 125 ms
Indicators/operating means	
LED yellow	indication of the switching state flashing: program function object detected

Release date: 2023-02-15 Date of issue: 2023-02-15 Filename: 204533_eng.pdf

Refer to "General Notes Relating to Pepperl+Fuchs Product Information".

Pepperl+Fuchs Group
www.pepperl-fuchs.com

USA: +1 330 486 0001
fa-info@us.pepperl-fuchs.com

Germany: +49 621 776 1111
fa-info@de.pepperl-fuchs.com

Singapore: +65 6779 9091
fa-info@sg.pepperl-fuchs.com



Technical Data

LED red	"Error", object uncertain in program function: No object detected	
Electrical specifications		
Operating voltage	U_B	10 ... 30 V DC , ripple 10 % _{SS}
No-load supply current	I_0	≤ 50 mA
Input		
Input type		1 program input, operating range 1: $-U_B ... +1$ V, operating range 2: $+4$ V ... $+U_B$ input impedance: > 4.7 kΩ; program pulse: ≥ 1 s
Output		
Output type		2 switch outputs NPN, normally open/closed
Rated operating current	I_e	2 x 100 mA , short-circuit/overload protected
Voltage drop	U_d	≤ 3 V
Repeat accuracy		≤ 1 %
Switching frequency	f	max. 3 Hz
Range hysteresis	H	1 % of the set operating distance
Temperature influence		± 1.5 % of full-scale value
Compliance with standards and directives		
Standard conformity		
Standards		EN IEC 60947-5-2:2020 IEC 60947-5-2:2019
Approvals and certificates		
UL approval		cULus Listed, Class 2 Power Source
CCC approval		CCC approval / marking not required for products rated ≤36 V
Ambient conditions		
Ambient temperature		-25 ... 70 °C (-13 ... 158 °F)
Storage temperature		-40 ... 85 °C (-40 ... 185 °F)
Mechanical specifications		
Connection type		Connector plug M12 x 1 , 5-pin
Housing diameter		18 mm
Degree of protection		IP67
Material		
Housing		brass, nickel-plated
Transducer		epoxy resin/hollow glass sphere mixture; foam polyurethane, cover PBT
Mass		60 g
Factory settings		
Output 1		Switching point: 90 mm output function: Switch point operation mode output behavior: NO contact
Output 2		Switching point: 1000 mm output function: Switch point operation mode output behavior: NC contact
Beam width		wide

Connection

Standard symbol/Connections:
(version E01, npn)

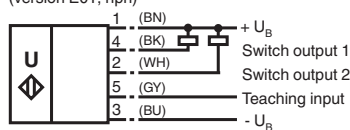

Core colours in accordance with EN 60947-5-2.

Release date: 2023-02-15 Date of issue: 2023-02-15 Filename: 204533_eng.pdf

Connection Assignment

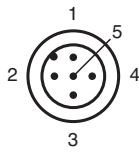

Wire colors in accordance with EN 60947-5-2

1	BN	(brown)
2	WH	(white)
3	BU	(blue)
4	BK	(black)
5	GY	(gray)

Characteristic Curve

Characteristic response curve

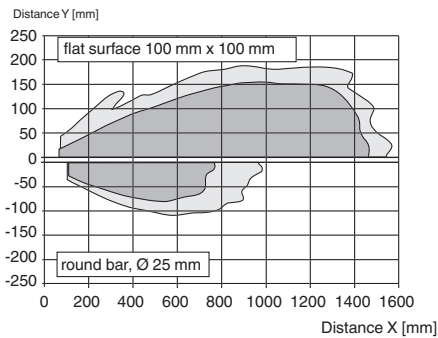

Programmed switching output function

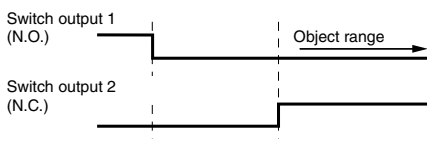

Switch point 1 -> ∞: Switch output 1, (N.O.)
 Detection of object presence
 Switch point 2 -> ∞: Switch output 2, (N.C.)
 Detection of object presence







Release date: 2023-02-15 Date of issue: 2023-02-15 Filename: 204533_eng.pdf

Accessories

	UB-PROG3	Programming unit
	OMH-04	Mounting aid for round steel ø 12 mm or sheet 1.5 mm ... 3 mm

Refer to "General Notes Relating to Pepperl+Fuchs Product Information".

Accessories

	BF 18	Mounting flange, 18 mm
	BF 18-F	Plastic mounting adapter, 18 mm
	BF 5-30	Universal mounting bracket for cylindrical sensors with a diameter of 5 ... 30 mm
	UVW90-K18	Ultrasonic -deflector
	M18K-VE	Plastic nuts with centering ring for the vibration-free mounting of cylindrical sensors
	V15-G-2M-PVC	Female cordset single-ended M12 straight A-coded, 5-pin, PVC cable grey
	V15-W-2M-PVC	Female cordset single-ended M12 angled A-coded, 5-pin, PVC cable grey

Release date: 2023-02-15 Date of issue: 2023-02-15 Filename: 204533_eng.pdf

Refer to "General Notes Relating to Pepperl+Fuchs Product Information".

Pepperl+Fuchs Group
www.pepperl-fuchs.com

USA: +1 330 486 0001
fa-info@us.pepperl-fuchs.com

Germany: +49 621 776 1111
fa-info@de.pepperl-fuchs.com

Singapore: +65 6779 9091
fa-info@sg.pepperl-fuchs.com

Programming procedure

The sensor features two switch outputs with one programmable switch point, each. Programming the switch points is done by applying the supply voltage $-U_B$ (switch output 1) or $+U_B$ (switch output 2) to the Teach-In input. The supply voltage must be applied to the Teach-In input for at least 1 s. LEDs indicate whether the sensor has recognized the target during the programming procedure.

Note:

Switching points may only be specified directly after Power on. A time lock secures the adjusted switching points against unintended modification 5 minutes after Power on. To modify the switching points later, the user may specify the desired values only after a new Power On.

Note:

If a programming adapter UB-PROG3 is used for the programming procedure, button A1 is assigned to $-U_B$ and button A2 is assigned to $+U_B$.

Programming switch outputs

Switch point for switch output 1

1. Place the target at the desired switch point position of switch output 1
2. Program the switch point by applying $-U_B$ to the Teach-In input (corresponding yellow LED flashes)
3. Disconnect the Teach-In input from $-U_B$ to save the switch point

Switch point for switch output 2

1. Place the target at the desired switch point position of switch output 2
2. Program the switch point by applying $+U_B$ to the Teach-In input (corresponding yellow LED flashes)
3. Disconnect the Teach-In input from $+U_B$ to save the switch point

Programming detection of object presence

1. Cover the sensor face with hand or remove all objects from sensing range
2. Apply $-U_B$ to the Teach-In input (red LED flashes)
3. Disconnect the Teach-In input from $-U_B$
4. Apply $+U_B$ to the Teach-In input (red LED flashes)
5. Disconnect the Teach-In input from $+U_B$

Note: Only one switch output can be configured for detection of presence of objects. If the sensor detects an object within the maximum detection range, the switch output switches.

Adjusting the sound cone characteristics:

The ultrasonic sensor enables two different shapes of the sound cone, a wide angle sound cone and a small angle sound cone.

1. Small angle sound cone

- switch off the power supply
- connect the Teach-In input wire to $-U_B$
- switch on the power supply
- the red LED flashes once with a pause before the next.
- yellow LED: permanently on: indicates the presence of an object or disturbing object within the sensing range
- disconnect the Teach-In input wire from $-U_B$ and the changing is saved



2. Wide angle sound cone

- switch off the power supply
- connect the Teach-In input wire with $+U_B$
- switch on the power supply
- the red LED double-flashes with a long pause before the next.
- yellow LED: permanently on: indicates an object or disturbing object within the sensing range
- disconnect the Teach-In input wire from $+U_B$ and the changing is saved



Factory Setting

Factory settings

See technical data.

Indication

The sensor provides LEDs to indicate various conditions.

	Red LED	Yellow LED 1	Yellow LED 2
During Normal operation			
Proper operation	Off	Switching state output 1	Switching state output 2
Interference (e.g. compressed air)	On	remains in previous state	remains in previous state
Programming of output 1			
Object detected	Off	Flashes	Off
No object detected	Flashes	Off	Off
Object uncertain (programming invalid)	On	Off	Off
Programming of output 2			
Object detected	Off	Off	Flashes
No object detected	Flashes	Off	Off
Object uncertain (programming invalid)	On	Off	Off

Installation Conditions

If the sensor is installed at places, where the environment temperature can fall below 0 °C, for the sensors fixation, one of the mounting flanges BF18, BF18-F or BF 5-30 must be used.

In case of direct mounting of the sensor in a through hole using the steel nuts, it has to be fixed at the middle of the housing thread. If a fixation at the front end of the threaded housing is required, plastic nuts with centering ring (accessories) must be used.

Release date: 2023-02-15 Date of issue: 2023-02-15 Filename: 204533_eng.pdf

Refer to "General Notes Relating to Pepperl+Fuchs Product Information".