



Fiber optic sensor

SU18/35/40a/102/115/126a



- Basic line for DIN rail installation
- High power version
- Sleek design
- 3 response times selectable
- Protected against mutual interference (no cross-talk)
- Self diagnosis function

Fiber optic sensor for glass fiber optics and plastic fiber optics



Dimensions

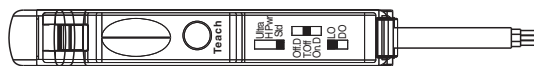
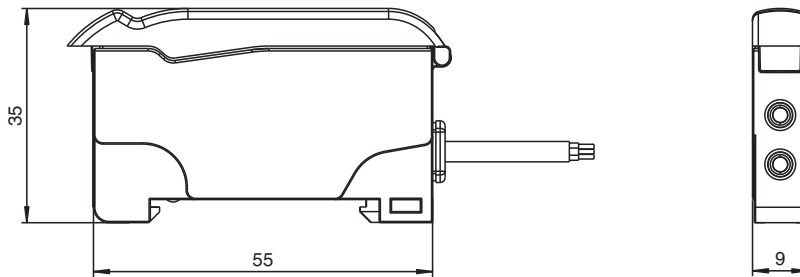

Ultra = Ultra
 HPwr = High-Power
 Std = Standard
 Off.D = Off Delay
 T.Off = Timer off
 On.D = On Delay
 LO = Light on
 DO = Dark on

Technical Data

General specifications

Sensor range	up to 460 mm (KLR-C02-2,2-2,0-K146)
Detection range	up to 1500 mm (KLE-C01-2,2-2,0-K116)
Light source	LED
Light type	modulated visible red light , 640 nm
Ambient light limit	10000 Lux

Functional safety related parameters

MTTF _d	690 a
Mission Time (T _M)	20 a
Diagnostic Coverage (DC)	0 %

Release date: 2023-07-21 Date of issue: 2023-07-21 Filename: 808451_eng.pdf

Refer to "General Notes Relating to Pepperl+Fuchs Product Information".

Pepperl+Fuchs Group
 www.pepperl-fuchs.com

USA: +1 330 486 0001
 fa-info@us.pepperl-fuchs.com

Germany: +49 621 776 1111
 fa-info@de.pepperl-fuchs.com

Singapore: +65 6779 9091
 fa-info@sg.pepperl-fuchs.com

PEPPERL+FUCHS

Technical Data

Indicators/operating means		
Operation indicator		LED green, statically lit Power on , Undervoltage indicator: Green LED, pulsing (approx. 0.8 Hz) , short-circuit : LED green flashing (approx. 4 Hz)
Function indicator		LED yellow: static illumination switching state, flashes when falling short of the operating reserve
Control elements		Teach-In key slide switch 2 positions: light/dark switching slide switch 3 positions: timer function - timer off, on delay 40 ms, off-delay 40 ms slide switch 3 positions: operating mode - Standard, High Power, Ultra
Electrical specifications		
Operating voltage	U_B	10 ... 30 V DC
Ripple		10 %
No-load supply current	I_0	≤ 30 mA
Output		
Stability alarm output		1 NPN, short-circuit protected open collector
Switching type		light/dark on, switchable
Signal output		1 NPN, short-circuit protected open collector
Switching voltage		max. 30 V DC
Switching current		max. 100 mA , resistive load
Voltage drop	U_d	≤ 2 V DC at 100 mA ; ≤ 0.7 V at 10 mA
Switching frequency	f	Standard mode: 3 kHz , High power mode: 1 kHz , Ultra mode: 100 Hz
Response time		Standard mode: 160 μs , High power mode: 500 μs , Ultra mode: 5 ms
Repeat accuracy	R	≤ 0.5 % of adjusted sensor range
Conformity		
Product standard		EN 60947-5-2
Approvals and certificates		
UL approval		cULus Listed, Class 2 Power Source, Type 1 enclosure
CCC approval		CCC approval / marking not required for products rated ≤36 V
Ambient conditions		
Ambient temperature		-10 ... 55 °C (14 ... 131 °F)
Storage temperature		-20 ... 70 °C (-4 ... 158 °F)
Mechanical specifications		
Housing width		9 mm
Housing height		34.5 mm
Housing depth		62.3 mm
Degree of protection		IP50
Connection		2 m PVC cable, 4 x 0,14 mm ²
Material		
Housing		PC
Mass		45 g

Release date: 2023-07-21 Date of issue: 2023-07-21 Filename: 808451_eng.pdf

Connection Assignment

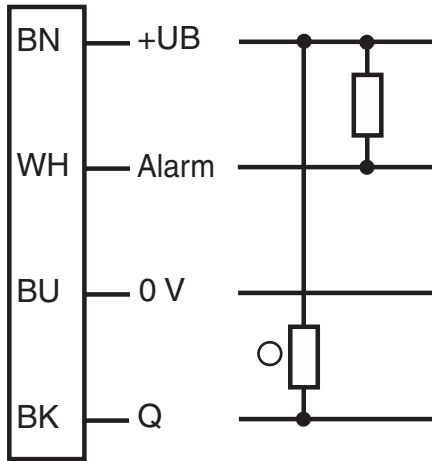

○ = Light on
● = Dark on

Characteristic Curve

Self-Diagnostic definition and operation:

5 sec. rule for light-ON (LO) and dark-ON (DO) mode

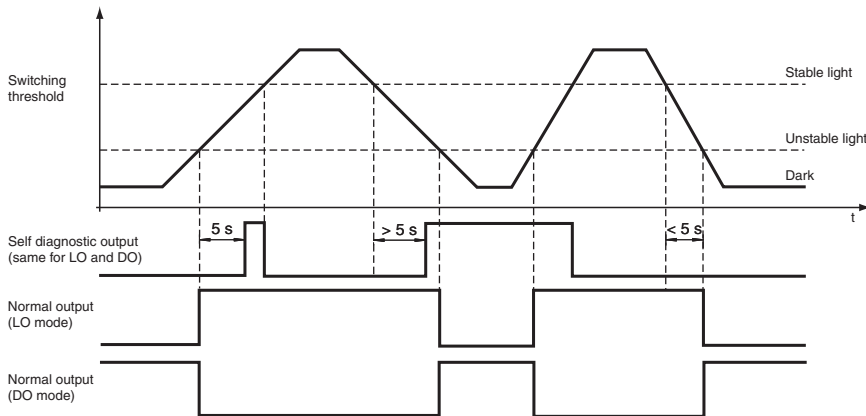

8 cyc. rule for light-ON (LO) and dark-ON (DO) mode

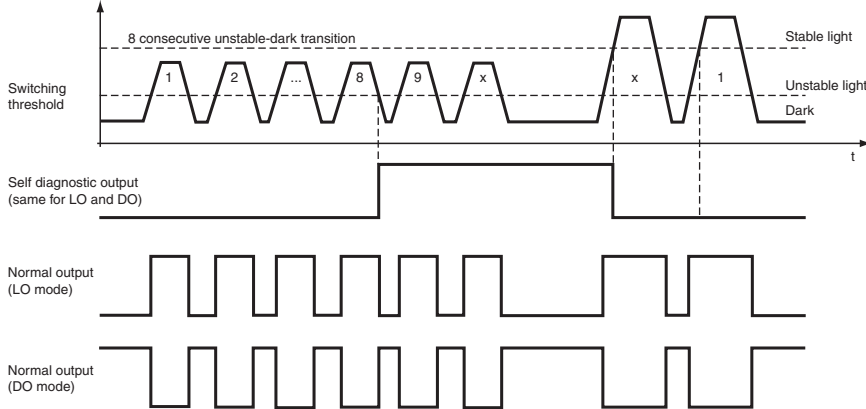

Release date: 2023-07-21 Date of issue: 2023-07-21 Filename: 808451_eng.pdf

Characteristic Curve

LED indicators and operating chart:

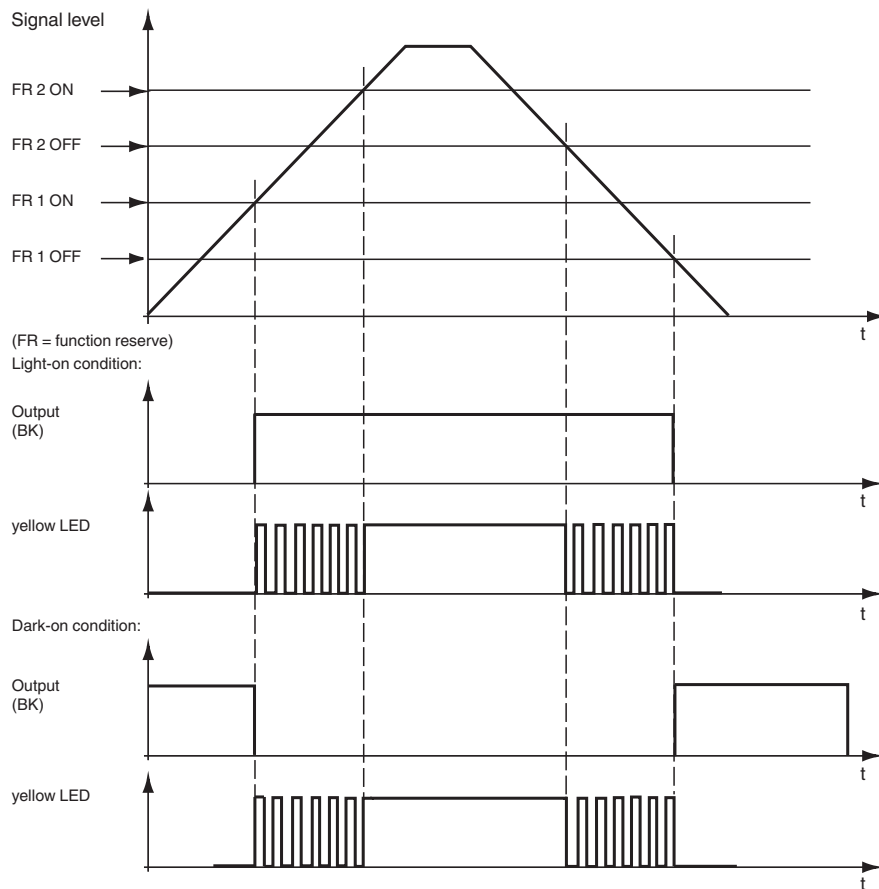

Accessories

	KLR-C02-2,2-2,0-K146	Plastic fiber optic - diffuse
	KLR-C02-2,2-2,0-K70	Plastic fiber optic - diffuse
	KLR-C02-1,0-2,0-K75	Plastic fiber optic - diffuse
	KLR-C09-1,25-2,0-K76	Plastic fiber optic - diffuse
	KLR-C09-1,25-2,0-K74	Plastic fiber optic - diffuse
	KLR-C16-2,2-2,0-K71	Plastic fiber optic - diffuse
	KLR-A32-2,2-2,0-K83	Plastic fiber optic - diffuse
	KHR-C02-2,2-2,0-K131	Plastic fiber optic - diffuse

Release date: 2023-07-21 Date of issue: 2023-07-21 Filename: 808451_eng.pdf

Refer to "General Notes Relating to Pepperl+Fuchs Product Information".

Pepperl+Fuchs Group
www.pepperl-fuchs.com











USA: +1 330 486 0001
fa-info@us.pepperl-fuchs.com



Germany: +49 621 776 1111
fa-info@de.pepperl-fuchs.com

Singapore: +65 6779 9091
fa-info@sg.pepperl-fuchs.com

PEPPERL+FUCHS

Accessories

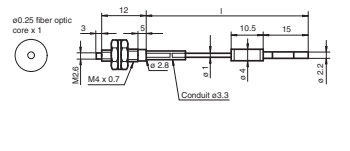
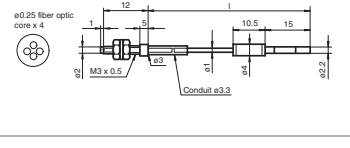
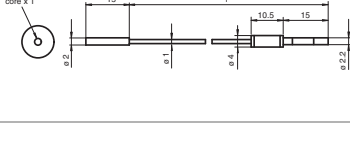
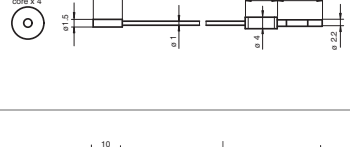
	KHTR-C02-2,2-2,0-K88	Plastic fiber optic - diffuse
	KLE-C01-2,2-2,0-K116	Plastic fiber optic - thru-beam
	KLE-C01-2,2-2,0-K103	Plastic fiber optic - thru-beam
	KLE-C01-2,2-2,0-K102	Plastic fiber optic - thru-beam
	KLE-C01-2,2-2,0-K101	Plastic fiber optic - thru-beam
	KLE-C01-2,2-2,0-K113	Plastic fiber optic - thru-beam
	KLE-C01-1,0-2,0-K120	Plastic fiber optic - thru-beam
	KHE-C01-2,2-2,0-K122	Plastic fiber optic - thru-beam
	KHTE-C01-2,2-2,0-K118	Plastic fiber optic - thru-beam
	LHE 00-1,1-1,0-20M4	Glass fiber optic - thru-beam with silicon covering

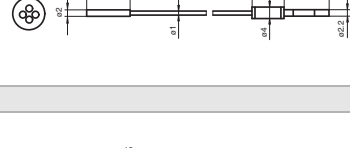
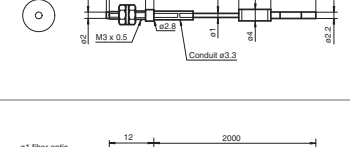
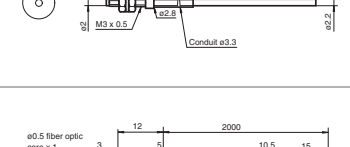
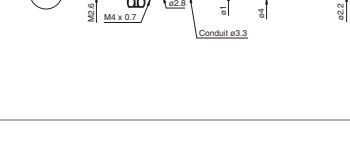
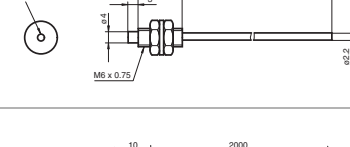
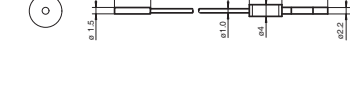
Head shape	Mounting	Model number	Core	Detection distance *	Fiber cross section	minimum Object size	Fiber optic length	Bend radius	Dimensions	Special features
Threaded	M4	KLE-C01-1.0-2.0-K119	PMMA	Ultra: 80 mm HiPwr: 45 mm Std: 20 mm	0.25 mm	0.05 mm	2 m	min. 10 mm		4 x high Detection range with Auxiliary lens K-LA01/ 8 x high Detection range with Auxiliary lens K-LA06/ Side view / Periscope with K-LA02
Threaded	M3 x 0.5	KLE-C04-1.0-2.0-K104	PMMA	Ultra: 300 mm HiPwr: 165 mm Std: 70 mm	4 x 0.25 mm	0.12 mm	2 m	min. 15 mm		
Cylindrical	dia. 2 mm	KLE-C01-1.0-2.0-K105	PMMA	Ultra: 80 mm HiPwr: 45 mm Std: 20 mm	0.25 mm	0.05 mm	2 m	min. 10 mm		
Cylindrical	dia. 1.5 mm	KLE-C01-1.0-2.0-K107	PMMA	Ultra: 80 mm HiPwr: 45 mm Std: 20 mm	0.25 mm	0.05 mm	2 m	min. 10 mm		
Cylindrical	dia. 1.5 mm	KLE-C04-1.0-2.0-K108	PMMA	Ultra: 300 mm HiPwr: 165 mm Std: 70 mm	4 x 0.25 mm	0.12 mm	2 m	min. 15 mm		
Cylindrical	dia. 2 mm	KLE-C04-1.0-2.0-K106	PMMA	Ultra: 300 mm HiPwr: 165 mm Std: 70 mm	4 x 0.25 mm	0.05 mm	2 m	min. 15 mm		
Highly flexible										
Threaded	M3	KHE-C01-1.0-2.0-K125	PMMA	Ultra: 210 mm HiPwr: 120 mm Std: 50 mm	0.5 mm	0.15 mm	2 m	min. 1 mm		only 1 mm Bend radius
Threaded	M3	KHE-C01-2.2-2.0-K122	PMMA	Ultra: 800 mm HiPwr: 480 mm Std: 200 mm	1 mm	0.25 mm	2 m	min. 2 mm		only 2 mm Bend radius
Threaded	M4 x 0.7 / M2.6	KHE-C01-1.0-2.0-K124	PMMA	Ultra: 210 mm HiPwr: 120 mm Std: 50 mm	0.5 mm	0.15 mm	2 m	min. 1 mm		4 x high Detection range with Auxiliary lens K-LA01/ 8 x high Detection range with Auxiliary lens K-LA06 Side view / Periscope with K-LA02/ only 1 mm Bend radius
Threaded	M6	KHE-C01-2.2-2.0-K121	PMMA	Ultra: 800 mm HiPwr: 480 mm Std: 200 mm	1.0 mm	0.25 mm	2 m	min. 2 mm		only 2 mm Bend radius
Cylindrical	dia. 1.5 mm	KHE-C01-1.0-2.0-K139	PMMA	Ultra: 210 mm HiPwr: 120 mm Std: 50 mm	0.5 mm	0.05 mm	2 m	min. 1 mm		only 1 mm Bend radius

Release date: 2023-07-21 Date of issue: 2023-07-21 Filename: 808451_eng.pdf

Refer to "General Notes Relating to Pepperl+Fuchs Product Information".

Pepperl+Fuchs Group
www.pepperl-fuchs.com

USA: +1 330 486 0001
fa-info@us.pepperl-fuchs.com

Germany: +49 621 776 1111
fa-info@de.pepperl-fuchs.com

Singapore: +65 6779 9091
fa-info@sg.pepperl-fuchs.com

Head shape	Mounting	Model number	Core	Detection distance *	Fiber cross section	minimum Object size	Fiber optic length	Bend radius	Dimensions	Special features
Cylindrical	dia. 3 mm	KHE-C01-2.2-2.0-K126	PMMA	Ultra: 210 mm HiPwr: 120 mm Std: 50 mm	0.5 mm	0.15 mm	2 m	min. 1 mm		only 1 mm Bend radius
Cylindrical	dia. 3 mm	KHE-C01-2.2-2.0-K123	PMMA	Ultra: 800 mm HiPwr: 480 mm Std: 200 mm	1 mm	0.25 mm	2 m	min. 2 mm		only 2 mm Bend radius
Right angle	dia. 15 x 5	KHE-C01-2.2-2.0-K137	PMMA	Ultra: 140 mm HiPwr: 80 mm Std: 35 mm	0.5 mm	0.15 mm	2 m	min. 1 mm		only 1 mm Bend radius
Right angle	dia. 15 x 5	KHE-C01-2.2-2.0-K140	PMMA	Ultra: 600 mm HiPwr: 350 mm Std: 150 mm	1 mm	0.25 mm	2 m	min. 2 mm		only 2 mm Bend radius
Flexible										
Threaded	M3 x 0.5 /M2.6	KLE-C01-1.3-2.0-K112	PMMA	Ultra: 800 mm HiPwr: 480 mm Std: 200 mm	1 mm	0.25 mm	2 m	min. 25 mm		4 x high Detection range with Auxiliary lens K-LA01/ 8 x high Detection range with Auxiliary lens K-LA06 Side view / Periscope with K-LA02
Threaded	M3 x 0.5	KLE-C01-2.2-2.0-K103	PMMA	Ultra: 920 mm HiPwr: 520 mm Std: 220 mm	1 mm	0.25 mm	2 m	min. 25 mm		
Threaded	M4 x 0.7 /M2.6	KLE-C01-2.2-2.0-K102	PMMA	Ultra: 920 mm HiPwr: 520 mm Std: 220 mm	1 mm	0.25 mm	2 m	min. 25 mm		4 x high Detection range with Auxiliary lens K-LA01/ 8 x high Detection range with Auxiliary lens K-LA06 Side view / Periscope with K-LA02
Threaded	M6	KLE-C01-2.2-2.0-K100	PMMA	Ultra: 920 mm HiPwr: 520 mm Std: 220 mm	1 mm	0.32 mm	2 m	min. 25 mm		
Threaded	M2.6	KLE-C01-2.2-2.0-K113	PMMA	Ultra: 800 mm HiPwr: 480 mm Std: 200 mm	1 mm	0.25 mm	2 m	min. 25 mm		4 x high Detection range with Auxiliary lens K-LA01/ 8 x high Detection range with Auxiliary lens K-LA06 Side view / Periscope with K-LA02
Cylindrical	dia. 2 mm	KLE-C01-1.3-2.0-K114	PMMA	Ultra: 920 mm HiPwr: 520 mm Std: 220 mm	1 mm	0.25 mm	2 m	min. 25 mm		
Cylindrical	dia. 5 mm	KLE-C01-2.2-2.0-K101	PMMA	Ultra: 920 mm HiPwr: 520 mm Std: 220 mm	1 mm	0.32 mm	2 m	min. 25 mm		
Bendable tip										

Release date: 2023-07-21 Date of issue: 2023-07-21 Filename: 808451_eng.pdf

Refer to "General Notes Relating to Pepperl+Fuchs Product Information".

Pepperl+Fuchs Group
www.pepperl-fuchs.com

USA: +1 330 486 0001
fa-info@us.pepperl-fuchs.com

Germany: +49 621 776 1111
fa-info@de.pepperl-fuchs.com

Singapore: +65 6779 9091
fa-info@sg.pepperl-fuchs.com

PEPPERL+FUCHS

Head shape	Mounting	Model number	Core	Detection distance *	Fiber cross section	minimum Object size	Fiber optic length	Bend radius	Dimensions	Special features
Slot	2 x 3.2 mm	KLE-C02-1.25-2.0-K134	PMMA	5 mm	2 x 0.25 mm		2 m	min. 10 mm		
Slot	2 x 3.2 mm	KLE-C02-1.25-2.0-K135	PMMA	10 mm	2 x 0.25 mm		2 m	min. 10 mm		

	<p>Std: Standard Mode, 160 μs HiPwr: HighPower Mode, 500 μs Ultra: Ultra Mode, 5 ms</p>
--	---

Selection table - diffuse mode fiber optic cable

Head shape	Mounting	Model number	Core	Detection distance *	Fiber cross-section	Fiber optic length	Bend radius	Dimensions	Special features
Highly precise									
Threaded	M3 x 0.5	KLR-C02-1.0-2.0-K75	PMMA	Ultra: 12 mm HiPwr: 6 mm Std: 4 mm	2 x 0.25 mm	2 m	min. 10 mm		
Threaded	M4 x 0.7	KLR-C02-1.0-2.0-K73	PMMA	Ultra: 12 mm HiPwr: 6 mm Std: 4 mm	2 x 0.25 mm	2 m	min. 10 mm		
Threaded	M3 x 0.5	KLR-C04-1.25-2.0-K78	PMMA	Ultra: 25 mm HiPwr: 18 mm Std: 8 mm	4 x 0.25 mm	2 m	min. 15 mm		
Cylindrical	dia. 2.0 mm	KLR-C02-1.0-2.0-K91	PMMA	Ultra: 12 mm HiPwr: 6 mm Std: 4 mm	2 x 0.25 mm	2 m	min. 10 mm		
Cylindrical	dia. 3.0 mm	KLR-C02-1.0-2.0-K90	PMMA	Ultra: 12 mm HiPwr: 6 mm Std: 4 mm	2 x 0.25 mm	2 m	min. 10 mm		
Cylindrical	dia. 1.5 mm	KLR-C04-1.25-2.0-K80	PMMA	Ultra: 25 mm HiPwr: 18 mm Std: 8 mm	4 x 0.25 mm	2 m	min. 15 mm		
Cylindrical	dia. 1.5 mm	KLR-C04-1.0-2.0-K133	PMMA	Ultra: 25 mm HiPwr: 18 mm Std: 7 mm	4 x 0.25 mm	2 m	min. 15 mm		

Release date: 2023-07-21 Date of issue: 2023-07-21 Filename: 808451_eng.pdf

Refer to "General Notes Relating to Pepperl+Fuchs Product Information".

