



Model Number

GLP50-RT/40b/102/123/143

Photoelectric slot sensor with 4-pin, M8 x 1 connector

Features

- Plastic version
- Clearly visible function indicators
- External TEACH-IN
- Degree of protection IP67

Product information

An extremely favorable price/performance ratio and an innovative display concept characterize the GLP series. The switching states are visible from all directions. The optional attachment holes or dove tail joint significantly increase installation flexibility. The external, dynamic Teach-In function allows you to teach in moving objects easily.

Dimensions

Type	A	B	C	D	E	F	G	Number of mounting holes M4*
GLP30-RT-	30	50	30	34	59.5	20	-	1
GLP50-RT-	50	70	50	54	79.5	20	-	2
GLP80-RT-	80	100	80	54	79.5	20	2 x 28	3
GLP120-RT-	120	140	120	54	79.5	20	3 x 28	4

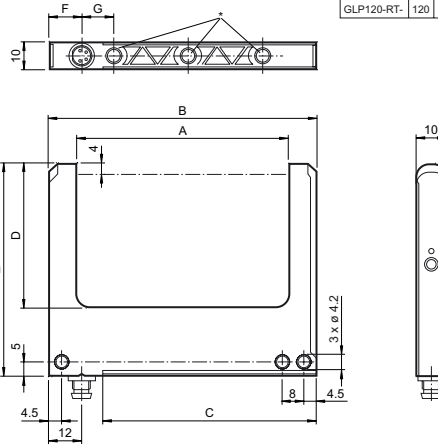

Electrical connection

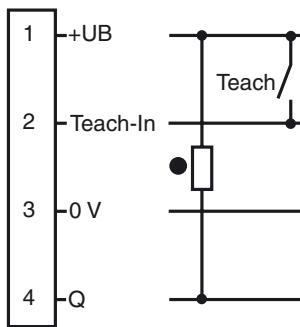

○ = Light on
● = Dark on

Pinout

Wire colors in accordance with EN 60947-5-2

1	BN	(brown)
2	WH	(white)
3	BU	(blue)
4	BK	(black)

Indicators/operating means

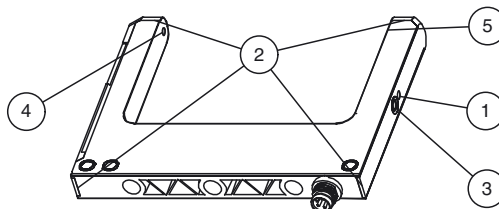

1	Operating display	green
2	Signal display	yellow
3	TEACH-IN button	
4	Emitter	
5	Receiver	

Release date: 2019-11-26 15:15 Date of issue: 2019-11-26 210604_eng.xml

Refer to "General Notes Relating to Pepperl+Fuchs Product Information".

Technical data**General specifications**

Light source	LED , 640 nm pulsing
Light type	modulated visible red light
Object size	min. 0.5 mm
Slot width	50 mm
Slot depth	54 mm
Ambient light limit	10000 Lux

Indicators/operating means

Function indicator	LED yellow , lit when the light beam is interrupted LED green: ready
Control elements	Teach-In key , Sensitivity adjustment and Mode adjustment (NO/NC)

Electrical specifications

Operating voltage	U_B	10 ... 30 V DC
Ripple		10 %
No-load supply current	I_0	≤ 30 mA

Input

Function input	external Teach-In
----------------	-------------------

Output

Switching type	light/dark on	
Signal output	1 NPN short-circuit protected, reverse polarity protected, open collector	
Switching voltage	max. 30 V DC	
Switching current	max. 100 mA	
Voltage drop	U_d	≤ 2.4 V
Switching frequency	f	2000 Hz
Response time		0.25 ms

Conformity

Product standard	EN 60947-5-2
------------------	--------------

Ambient conditions

Ambient temperature	-20 ... 60 °C (-4 ... 140 °F)
Storage temperature	-20 ... 80 °C (-4 ... 176 °F)

Mechanical specifications

Degree of protection	IP67
Connection	M8 connector, 4-pin
Material	
Housing	PC
Optical face	plastic
Mass	30 g

Approvals and certificates

Protection class	II
UL approval	cULus Listed, Class 2 Power Source "For use in NFPA 79 Applications only" Adapters providing field wiring means are available from the manufacturer. Refer to manufacturers information.

Accessories**OMH-K03**

dove tail mounting clamp

V31-WM-2M-PUR

Female cordset single-ended, M8, 4-pin, PUR cable

V31-GM-2M-PUR

Female cordset single-ended, M8, 4-pin, PUR cable

V31-GM-BK2M-PUR-U

Female cordset single-ended, M8, 4-pin, PUR cable

V31-WM-BK2M-PUR-U

Female cordset single-ended, M8, 4-pin, PUR cable

Other suitable accessories can be found at www.pepperl-fuchs.com