



## Retroreflective sensor ML100-55-6086/103



- Miniature design
- Easy to use
- Clearly visible LEDs for Power ON, switching state and weak signal indication
- Full metal thread mounting
- Very bright, highly visible light spot
- Not sensitive to ambient light

Retroreflective sensor with polarization filter, plastic housing, 5 m detection range, red light, sensitivity adjuster, light/dark on, DC version, PNP output, fixed cable



### Function

The optical sensors of this series are suitable for both standard and demanding applications. The series features a miniature housing design, two M3 metal-threaded mounting holes and a highly visible LED status indicator. Each device is equipped with a sensitivity adjuster and a light-on/dark-on changeover switch for increased flexibility. A wide variety of versions are available in both infrared light and red light with PowerBeam for easy alignment. Special versions with BlueBeam are suitable for challenging applications like those in the solar and battery industries.

### Dimensions

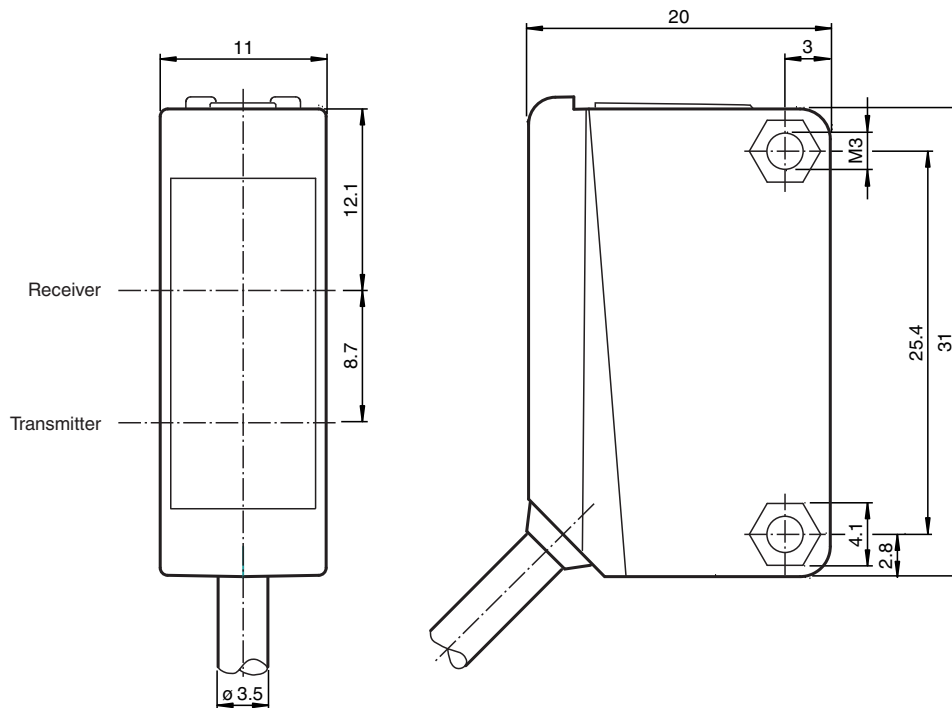

Release date: 2023-03-28 Date of issue: 2023-03-28 Filename: 813877\_eng.pdf

Refer to "General Notes Relating to Pepperl+Fuchs Product Information".

Pepperl+Fuchs Group  
www.pepperl-fuchs.com

USA: +1 330 486 0001  
fa-info@us.pepperl-fuchs.com

Germany: +49 621 776 1111  
fa-info@de.pepperl-fuchs.com

Singapore: +65 6779 9091  
fa-info@sg.pepperl-fuchs.com

**PF** PEPPERL+FUCHS

## Technical Data

General specifications		
Effective detection range		0 ... 5 m
Reflector distance		0.01 ... 5 m
Threshold detection range		7 m
Reference target		H50 reflector
Light source		LED
Light type		modulated visible red light
Polarization filter		yes
Diameter of the light spot		approx. 500 mm at a distance of 7 m
Opening angle		approx. 4 °
Optical face		frontal
Ambient light limit		EN 60947-5-2:2007+A1:2012
Functional safety related parameters		
MTTF <sub>d</sub>		860 a
Mission Time (T <sub>M</sub> )		20 a
Diagnostic Coverage (DC)		0 %
Indicators/operating means		
Operation indicator		LED green: power on LED yellow: switching state
Control elements		sensitivity adjustment
Control elements		Light-on/dark-on changeover switch
Electrical specifications		
Operating voltage	U <sub>B</sub>	10 ... 30 V DC
Ripple		max. 10 %
No-load supply current	I <sub>0</sub>	< 20 mA
Output		
Switching type		The switching type of the sensor is adjustable. The default setting is: light-on
Signal output		1 PNP output, short-circuit protected, reverse polarity protected, open collector
Switching voltage		max. 30 V DC
Switching current		max. 100 mA , resistive load
Voltage drop	U <sub>d</sub>	≤ 1.5 V DC
Switching frequency	f	500 Hz
Response time		1 ms
Conformity		
Product standard		EN 60947-5-2
Approvals and certificates		
UL approval		cULus Listed, Class 2 Power Source or listed Power Supply with a limited voltage output with (maybe integrated) fuse (max. 3.3 A according UL248), Type 1 enclosure
CCC approval		CCC approval / marking not required for products rated ≤36 V
Ambient conditions		
Ambient temperature		-30 ... 60 °C (-22 ... 140 °F)
Storage temperature		-40 ... 70 °C (-40 ... 158 °F)
Mechanical specifications		
Housing width		11 mm
Housing height		31 mm
Housing depth		20 mm
Degree of protection		IP67
Connection		2 m fixed cable
Material		
Housing		PC (Polycarbonate)
Optical face		PMMA
Mass		approx. 50 g
Tightening torque, fastening screws		0.6 Nm
Cable length		2 m

Release date: 2023-03-28 Date of issue: 2023-03-28 Filename: 813877\_eng.pdf

Refer to "General Notes Relating to Pepperl+Fuchs Product Information".

Pepperl+Fuchs Group  
www.pepperl-fuchs.comUSA: +1 330 486 0001  
fa-info@us.pepperl-fuchs.comGermany: +49 621 776 1111  
fa-info@de.pepperl-fuchs.comSingapore: +65 6779 9091  
fa-info@sg.pepperl-fuchs.com

**PEPPERL+FUCHS**

**Connection**

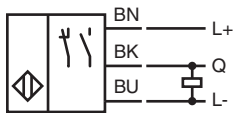

**Assembly**

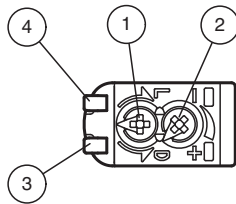

1	Light-Dark-switching	
2	Sensitivity adjuster	
3	Signal display	yellow
4	Operating display	green

**Characteristic Curve**

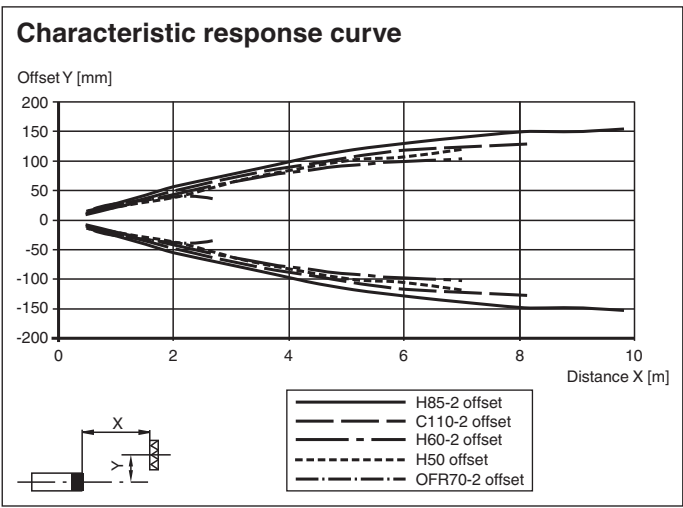

Release date: 2023-03-28 Date of issue: 2023-03-28 Filename: 813877\_eng.pdf

Refer to "General Notes Relating to Pepperl+Fuchs Product Information".

Characteristic Curve

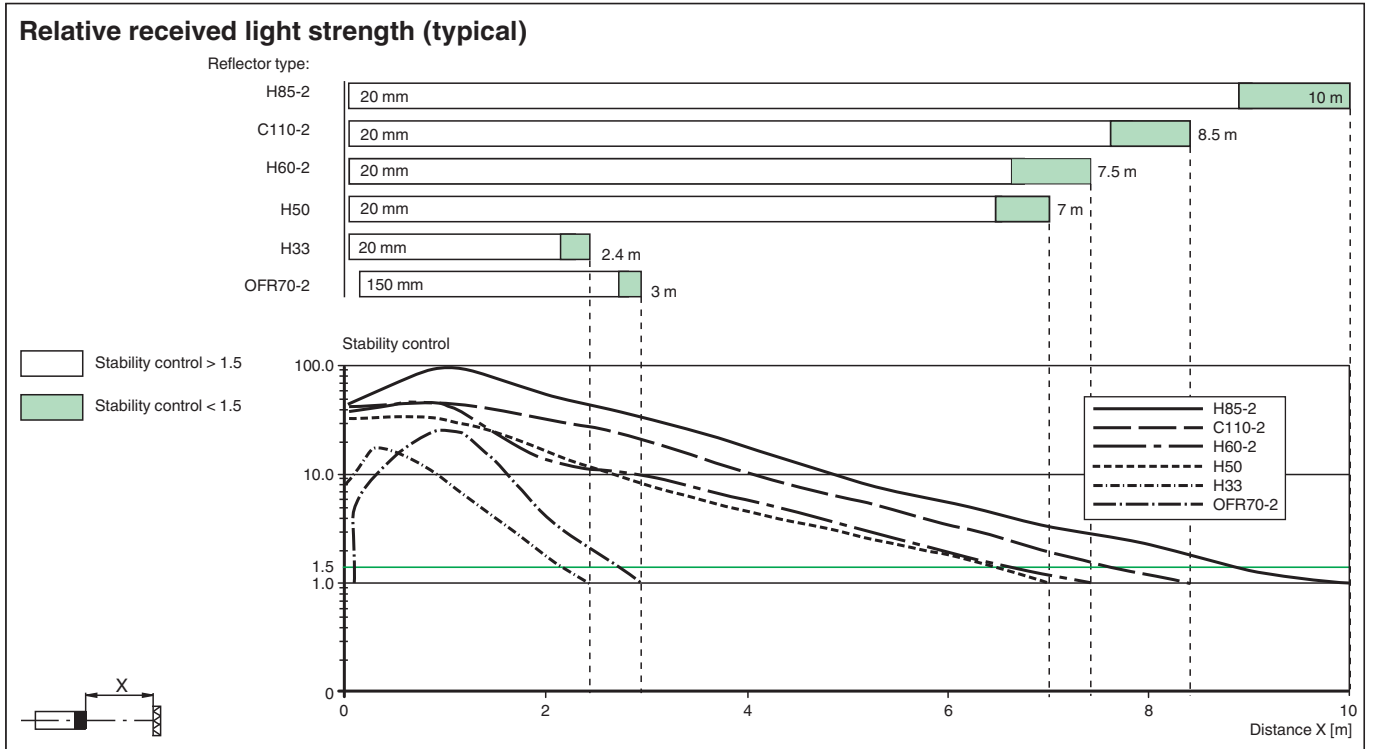







Accessories

	<b>OMH-ML100-09</b>	Mounting aid for round steel $\varnothing$ 12 mm or sheet 1.5 mm ... 3 mm
	<b>OMH-F10-ML100</b>	Mounting aid for ML100 series
	<b>OMH-ML100-01</b>	Mounting aid for ML100 series, mounting bracket
	<b>OMH-ML100-02</b>	Mounting aid for ML100 series, mounting bracket
	<b>OMH-ML100-03</b>	Mounting aid for round steel $\varnothing$ 12 mm or sheet 1.5 mm ... 3 mm
	<b>OMH-ML100-04</b>	Mounting aid for ML100 series, mounting bracket
	<b>OMH-ML100-05</b>	Mounting aid for ML100 series, mounting bracket
	<b>OMH-10</b>	Mounting aid for ML100 series
	<b>REF-C110-2</b>	Reflector, round $\varnothing$ 84 mm, central mounting hole
	<b>REF-H60-2</b>	Reflector with mounting holes
	<b>REF-H33</b>	Reflector with screw fixing

Release date: 2023-03-28 Date of issue: 2023-03-28 Filename: 813877\_eng.pdf

## Accessories

	<b>OFR-70-2</b>	Reflective tape 70 mm x 70 mm
	<b>REF-MH23-2</b>	Reflector with Micro-structure, rectangular 23 mm x 14 mm, diagonal mounting hole
	<b>OMH-ML100-S1</b>	Mounting bracket
	<b>REF-H85-2</b>	Reflector, rectangular 84.5 mm x 84.5 mm, mounting holes
	<b>REF-H50</b>	Reflector, rectangular 51 mm x 61 mm, mounting holes, fixing strap
	<b>OFR-100/100</b>	Reflective tape 100 mm x 100 mm