



Adapter cable

V15B-G-10M-PUR-ABG-SUBD9

- Halogen-free
- Shield connected to connector

Adapter cable M12 socket straight B-coded 5-pin to Sub-D-socket straight 9-pin, PUR cable grey, shielded



Dimensions

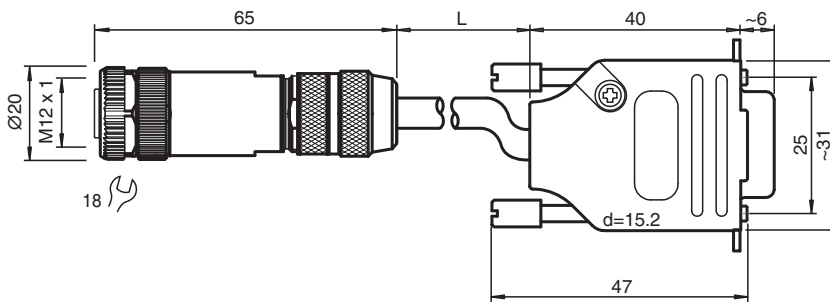

Technical Data

General specifications

Connector 1	
Connection	socket
Construction type	M12
Style	straight
Locking	screw connection
Number of pins	5
Coding	B-coded
Connector 2	
Connection	socket
Construction type	Sub-D
Style	straight
Locking	screw connection
Number of pins	9

Electrical specifications

Operating voltage	U_B	max. 36 V DC to be defined
Operating current	I_B	max. 1.5 A to be defined

Conformity

Degree of protection	EN 60529
Plug connection	connector M12 x 1 : IEC 61076-2-101 Connector Sub-D : IEC 807-2

Release date: 2023-07-12 Date of issue: 2023-07-13 Filename: 70155721_eng.pdf

Refer to "General Notes Relating to Pepperl+Fuchs Product Information".

Pepperl+Fuchs Group
www.pepperl-fuchs.com

USA: +1 330 486 0001
fa-info@us.pepperl-fuchs.com

Germany: +49 621 776 1111
fa-info@de.pepperl-fuchs.com

Singapore: +65 6779 9091
fa-info@sg.pepperl-fuchs.com

PEPPERL+FUCHS

Technical Data

Halogen-free		DIN VDE 0472-815 DIN EN 50267-2-1
Ambient conditions		
Ambient temperature		
Connector 1		-40 ... 85 °C (-40 ... 185 °F)
Connector 2		-55 ... 105 °C (-67 ... 221 °F)
Cable, fixed		-40 ... 80 °C (-40 ... 176 °F)
Cable, flexing		-25 ... 80 °C (-13 ... 176 °F)
Pollution degree		3
Mechanical specifications		
Connector 1		
Tightening torque		0.6 Nm
Tool installation		straight knurling , hexagon nut SW = 18 mm
Mating cycles		min. 50
Shielding		iris spring shielding
Degree of protection		IP67
Connector 2		
Loosening protection		screws UNC 4-40
Mating cycles		min. 100
Shielding		shield connected to connector
Degree of protection		IP20
Cable		
Sheath diameter		4.8 mm
Bending radius		> 10 x cable diameter, moving > 5 x cable diameter, fixed
Sheath stripping force		max. 100 N / 300 mm
Sheath color		grey (similar to RAL 7001)
Number of cores		4
Core cross section		0.34 mm ²
Cores color		Core 1-2: brown Core 2-7: white Core 3-1: blue Core 4-6: black
Core construction		19 x 0.15 mm Ø
Shield		tinned copper braiding, 85 % coverage
Length	L	10 m
Cable code		Li 9Y 11YM 4 x 0.34
Material		
Halogen-free		yes
Connector 1		
Screw connection		Zinc diecast, nickel-plated
Body		Zinc diecast, nickel-plated
Contact surface		gold plated (Au)
Connector 2		
Body		Zinc diecast, nickel-plated
Contact surface		gold plated (Au)
Flammability		V-0
Cable		
Sheathing		PUR based on polyether
Core insulation		PP
Chemical resistance		good

Release date: 2023-07-12 Date of issue: 2023-07-13 Filename: 70155721_eng.pdf

Refer to "General Notes Relating to Pepperl+Fuchs Product Information".

Pepperl+Fuchs Group
www.pepperl-fuchs.com

USA: +1 330 486 0001
fa-info@us.pepperl-fuchs.com

Germany: +49 621 776 1111
fa-info@de.pepperl-fuchs.com





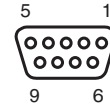
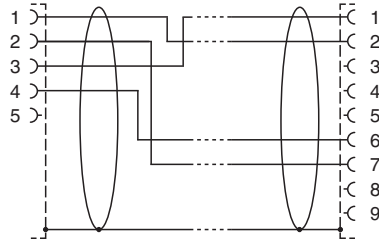
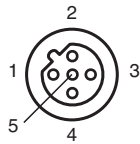

Singapore: +65 6779 9091
fa-info@sg.pepperl-fuchs.com

 PEPPERL+FUCHS

Connection



Accessories

	MH V1-SCREWDRIVER	Torque screwdriver (0.6 Nm)
	MH V1-BIT M12	plug-in cap M12
	V1/V3-LABELHOLDER	Label holder
	V1/V3-LABEL	Label plate
	MH V1-Holder	Modular universal holder for M12 connectors
	V1-CLIP	Unlocking protector for M12 connector
	V1-MARKING-RING-COLOR	Marking rings for M12 connectors, various colors

Release date: 2023-07-12 Date of issue: 2023-07-13 Filename: 70155721_eng.pdf