



Distance sensor

OMT550-R200-IEP-IO-0,3M-V1



- Medium design with versatile mounting options
- Space-saving distance sensors in small standardized design
- Multi Pixel Technology (MPT) - exact and precise signal evaluation
- IO-Link interface for service and process data
- Analog output 4 ... 20 mA

Distance sensor



IO-Link

Function

The optical sensors in the series are the first devices to offer an end-to-end solution in a medium-sized standard design – from the thru-beam sensor through to the measuring distance sensor. As a result of this design, the sensors are able to perform practically all standard automation tasks.

The entire series enables sensors to communicate via IO-Link.

The DuraBeam laser sensors are durable and can be used in the same way as a standard sensor.

Multi Pixel Technology (MPT) ensures that the standard sensors are flexible and can be adapted to the application environment.

Dimensions

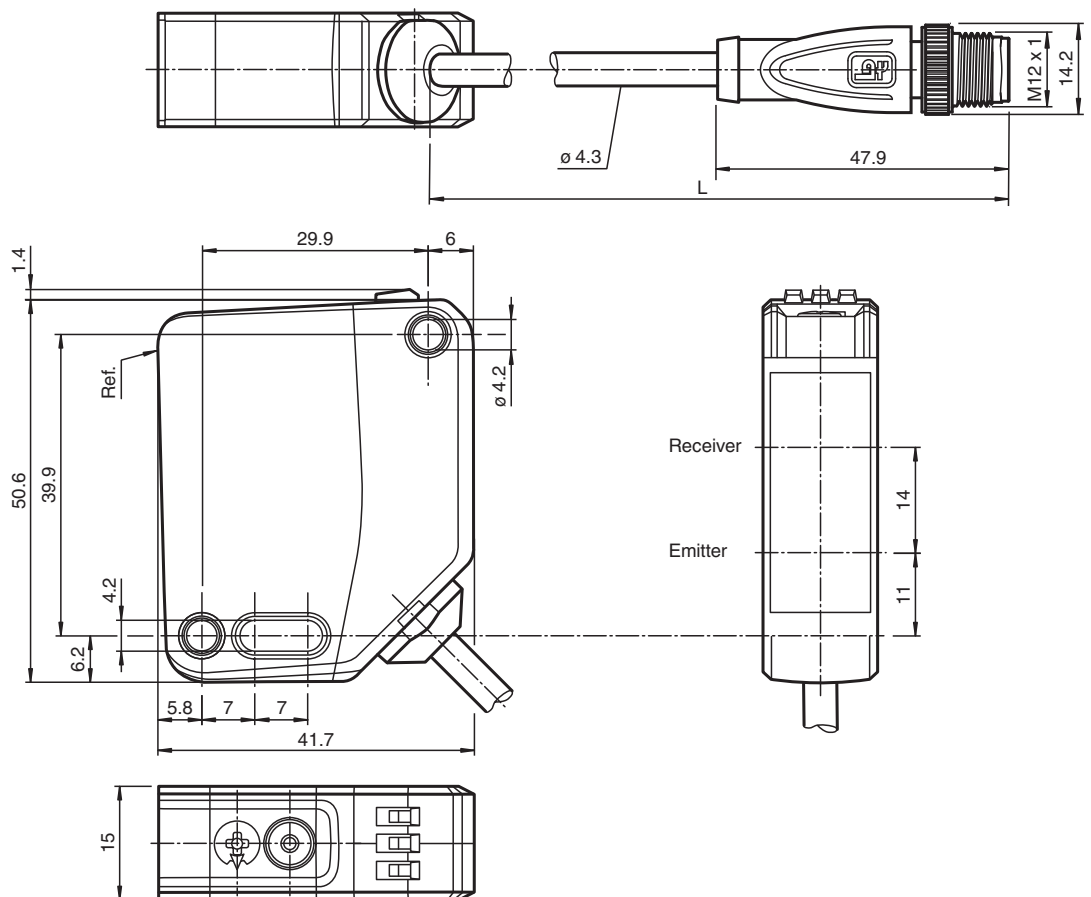

Technical Data

General specifications		
Measurement range		100 ... 550 mm
Reference target		standard white, 100 mm x 100 mm
Light source		LED
Light type		modulated visible red light
LED risk group labelling		exempt group
Angle deviation		max. +/- 1.5 °
Diameter of the light spot		approx. 20 mm at a distance of 550 mm
Opening angle		2.5 °
Ambient light limit		EN 60947-5-2 : 45000 Lux
Resolution		0.1 mm
Functional safety related parameters		
MTTF _d		520 a
Mission Time (T _M)		20 a
Diagnostic Coverage (DC)		0 %
Indicators/operating means		
Operation indicator		LED green: constantly on - power on flashing (4Hz) - short circuit flashing with short break (1 Hz) - IO-Link mode
Function indicator		LED yellow: constantly on - switch output active constantly off - switch output inactive
Control elements		Teach-In key
Control elements		5-step rotary switch for operating modes selection
Electrical specifications		
Operating voltage	U _B	18 ... 30 V DC
Ripple		max. 10 %
No-load supply current	I ₀	< 25 mA at 24 V supply voltage
Protection class		III
Interface		
Interface type		IO-Link (via C/Q = pin 4)
IO-Link revision		1.1
Device profile		Identification and diagnosis Smart Sensor type 0/type 3.3
Device ID		0x111902 (1120514)
Transfer rate		COM2 (38.4 kBit/s)
Min. cycle time		3 ms
Process data width		Process data input 4 byte Process data output 2 bits
SIO mode support		yes
Compatible master port type		A
Output		
Switching type		The default setting is: C/Q - Pin4: NPN normally open, PNP normally closed, IO-Link I—Pin2: analog output 4...20 mA
Signal output		1 push-pull output , 1 analog output , short-circuit-proof, reverse polarity protection, surge-proof
Switching voltage		max. 30 V DC
Switching current		max. 100 mA , resistive load
Usage category		DC-12 and DC-13
Voltage drop	U _d	≤ 1.5 V DC
Response time		2 ms , see table 1
Analog output		
Output type		1 current output: 4 ... 20 mA
Load resistor		> 1 kΩ voltage output ; ≤ 470 Ω current output
Recovery time		2 ms

Release date: 2023-01-24 Date of issue: 2023-01-24 Filename: 295670-100254_eng.pdf

Refer to "General Notes Relating to Pepperl+Fuchs Product Information".

Technical Data

Conformity	
Communication interface	IEC 61131-9
Product standard	EN 60947-5-2
Measurement accuracy	
Temperature drift	0.05 %/K
Warm up time	5 min
Repeat accuracy	≤ 1 % , see table 1
Linearity error	0.75 %
Approvals and certificates	
UL approval	E87056 , cULus Listed , class 2 power supply , type rating 1
CCC approval	CCC approval / marking not required for products rated ≤36 V
Ambient conditions	
Ambient temperature	10 ... 50 °C (50 ... 122 °F)
Storage temperature	-40 ... 70 °C (-40 ... 158 °F)
Mechanical specifications	
Housing width	15 mm
Housing height	50.6 mm
Housing depth	41.7 mm
Degree of protection	IP67 / IP69 / IP69K
Connection	300 mm fixed cable with M12 x 1, 4-pin connector
Material	
Housing	PC (Polycarbonate)
Optical face	PMMA
Mass	approx. 45 g
Cable length	0.3 m

Connection

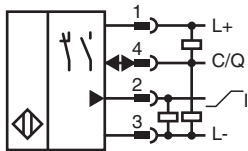

Connection Assignment

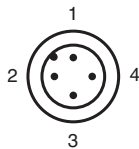

Wire colors in accordance with EN 60947-5-2

1	BN	(brown)
2	WH	(white)
3	BU	(blue)
4	BK	(black)

Assembly

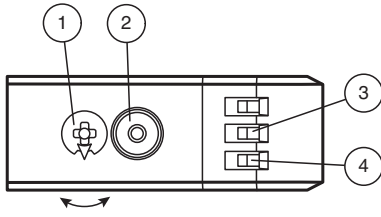

1	Mode rotary switch	
2	Teach-in button	
3	Switching output display Q1	YE
4	Operating indicator	GN

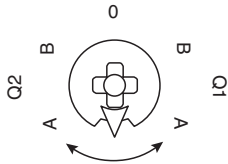

Q1B	Switching output/switch point B
Q1A	Switching output/switch point A
Q2A	Analog output/value A
Q2B	Analog output/value B
0	Keylock

Accessories

	OMH-MLV12-HWK	Mounting bracket for series MLV12 sensors
	OMH-R200-01	Mounting aid for round steel ø 12 mm or sheet 1.5 mm ... 3 mm
	OMH-R20x-Quick-Mount	Quick mounting accessory
	OMH-MLV12-HWG	Mounting bracket for series MLV12 sensors
	ICE2-8IOL-G65L-V1D	EtherNet/IP IO-Link master with 8 inputs/outputs
	ICE3-8IOL-G65L-V1D	PROFINET IO IO-Link master with 8 inputs/outputs
	ICE2-8IOL-K45S-RJ45	EtherNet/IP IO-Link master with 8 inputs/outputs, DIN rail, screw terminal
	ICE3-8IOL-K45P-RJ45	PROFINET IO IO-Link master with 8 inputs/outputs, DIN rail, push-in terminals
	ICE3-8IOL-K45S-RJ45	PROFINET IO IO-Link master with 8 inputs/outputs, DIN rail, screw terminal
	IO-Link-Master02-USB	IO-Link master, supply via USB port or separate power supply, LED indicators, M12 plug for sensor connection
	ICE1-8IOL-G30L-V1D	Ethernet IO-Link module with 8 inputs/outputs
	ICE1-8IOL-G60L-V1D	Ethernet IO-Link module with 8 inputs/outputs
	ICE2-8IOL-K45P-RJ45	EtherNet/IP IO-Link master with 8 inputs/outputs, DIN rail, push-in connectors
	V1-G-2M-PUR	Female cordset single-ended M12 straight A-coded, 4-pin, PUR cable grey

Release date: 2023-01-24 Date of issue: 2023-01-24 Filename: 295670-100254_eng.pdf

Accessories

	V1-W-2M-PUR	Female cordset single-ended M12 angled A-coded, 4-pin, PUR cable grey
---	--------------------	---

Release date: 2023-01-24 Date of issue: 2023-01-24 Filename: 295670-100254_eng.pdf

Refer to "General Notes Relating to Pepperl+Fuchs Product Information".

Pepperl+Fuchs Group
www.pepperl-fuchs.comUSA: +1 330 486 0001
fa-info@us.pepperl-fuchs.comGermany: +49 621 776 1111
fa-info@de.pepperl-fuchs.comSingapore: +65 6779 9091
fa-info@sg.pepperl-fuchs.com **PEPPERL+FUCHS**

Technical Features

Table 1: Information on Measured Value Filters

Measured value filter	1-way	2-way	4-way	16-way	64-way	256-way
Filter	1-way	2-way	4-way	16-way	64-way	256-way
Response time (ms)	2	4	8	32	128	512
Repeatability (%)	< 1 %					

Settings

Teach-In (TI)

Use the rotary switch for switching signal **Q1** to select the relevant switching threshold A and/or B to teach in.

- The yellow LEDs indicate the current state of the selected output.

To teach in a switching threshold, press and hold the "TI" button for approximately 1 s, until the yellow and green LEDs flash in phase. Teach-in starts when the "TI" button is released.

- Teach-in successful: the yellow and green LEDs flash alternately at 2.5 Hz.
- Teach-in unsuccessful: the yellow and green LEDs quickly flash alternately at 8 Hz.

After an unsuccessful Teach-in, the sensor continues to operate with the previous valid setting after the relevant visual fault signal is issued.

Set switching mode: you can define different switching modes by teaching in the relevant distance data for switching thresholds A and B.

1. Single point mode:

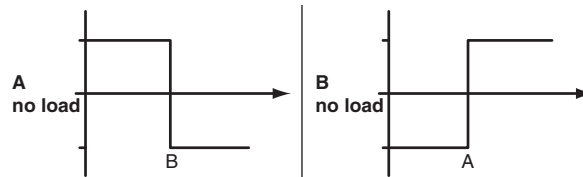

2. Window mode:

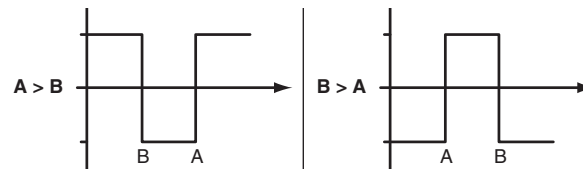

Teach in switching thresholds: you can teach in or overwrite a taught-in switching threshold at any time. To do this, press the "TI" button again.

Reset a value: you can reset a taught-in value. To do this, press the "TI" button for > 4 s, until the yellow and green LEDs go out. The reset process itself starts when the "TI" button is released.

- Reset successful: the yellow and green LEDs flash alternately at 2.5 Hz.
- Minimum and maximum values for the analog output Q2 are taught in and deleted in the same way as those for the switching output.

The following applies:

- A = Minimum voltage/current
- B = Maximum voltage/current

Resetting to Factory Settings

To revert back to factory settings, press the "TI" button for > 10 s with the rotary switch set to position "O," until the yellow and green LEDs go out at the same time. The reset process itself starts when the "TI" button is released.

- Reset to factory settings successful: the yellow and green LEDs light up at the same time. The sensor then continues to operate with factory settings.

OMT-IEP

- Factory setting for switching signal Q1:
Switching signal is high active, window mode

- Analog output: current output, 4 mA ... 20 mA absolute mode OMT-UEP
- Factory setting for switching signal Q1: Switching signal is high active, window mode
- Analog output: voltage output, 0 V ... 10 V absolute mode

Analog output

The analog output type can be configured as voltage or current output via IO-Link.
The following output types are available:

- Analog output 0 mA ... 20 mA
- Analog output 4 mA ... 20 mA
- Analog output 0 V ... 10 V

The following operating modes are available:

- Absolute mode (default setting)
- Normalized mode
- Rising slope
- Falling slope

The following substitute values can optionally be configured:

- No substitute values used (default setting)
- Substitute value for "no measured value" used
- Substitute value for "no measured value" and "Measuring overrange" used

The sensor's tolerances are based on the digital process data.

Absolute mode (default setting, A and B = deleted)

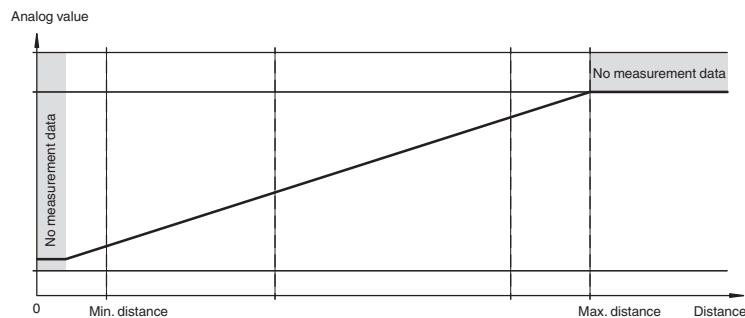

Normal mode (A and B without teach-in / deleted)

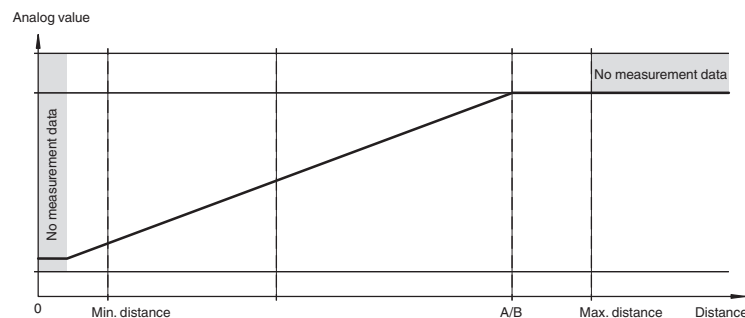

Rising slope (A < B)

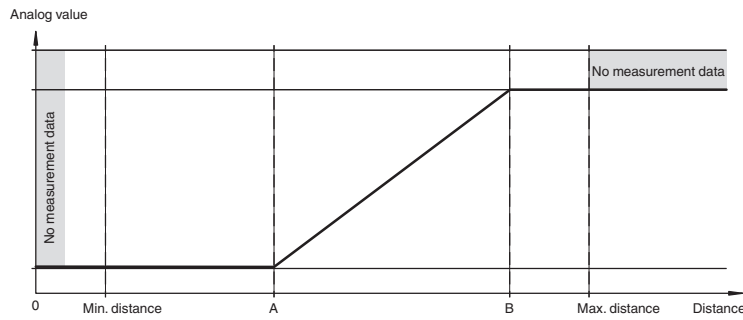

Falling slope (A > B)

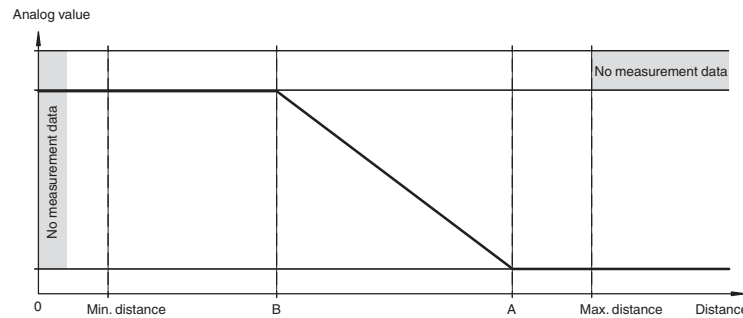

Configuration

Setting different operating modes via the IO-Link interface

The devices are equipped with an IO-Link interface as standard for diagnostics and parameterization tasks to ensure optimum adjustment of the sensors to the relevant application.

Single point mode operating mode (one switch point):

- "Detection of objects irrespective of type and color in a defined detection range. Objects in the background are suppressed.
- "The switch point corresponds exactly to the set point.



Window mode operating mode (two switch points):

- Detection of objects irrespective of type and color in a defined detection range. Reliable detection when object leaves the detection range.
- Window mode with two switch points.



Center window mode operating mode (one switch point):

- Detection of objects irrespective of type and color in a defined detection range. Sets a defined window around a given object. Objects outside this window are not detected.
- Window mode with one switch point.



Two point mode operating mode (hysteresis operating mode):

- Detection of objects irrespective of type and color between a defined switch-on and switch-off point.

Release date: 2023-01-24 Date of issue: 2023-01-24 Filename: 295670-100254_eng.pdf

Refer to "General Notes Relating to Pepperl+Fuchs Product Information".

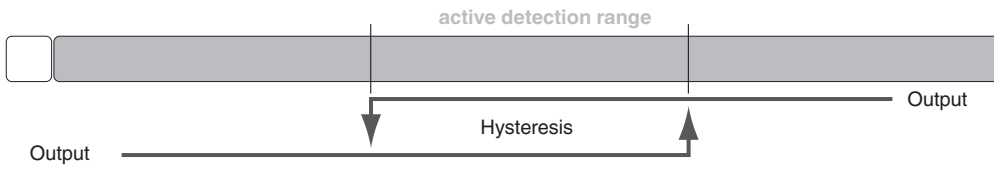

Inactive operating mode:

- Evaluation of switching signals is deactivated.

The associated IODD device description file can be found in the download area at www.pepperl-fuchs.com.