



## Ultrasonic direct detection sensor UB400-F77-F-V31

- Miniature design
- Frequency output
- Program input
- Degree of protection IP67
- Switching status indicator, yellow LED

Ultrasonic direct detection sensor



### Function

The ultrasonic sensor transmits ultrasonic packages in quick succession and responds to their reflection off the detected object. It has a frequency output that delivers a square wave signal. The frequency of this signal changes linearly with the distance of the object. Two frequency ranges are available.

### Dimensions

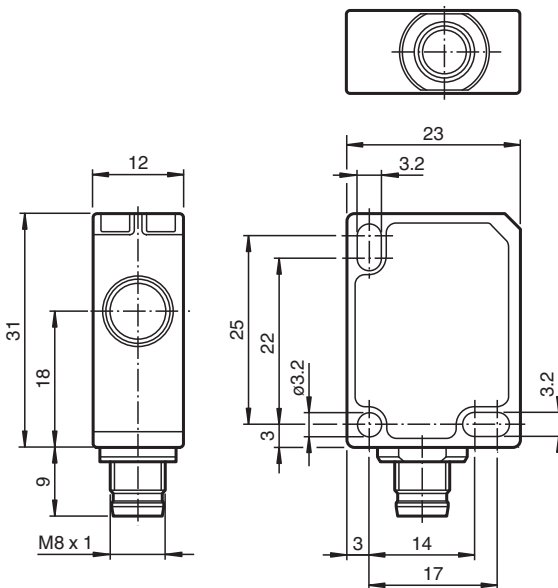

### Technical Data

#### General specifications

Sensing range	40 ... 400 mm
Dead band	0 ... 40 mm
Standard target plate	20 mm x 20 mm
Transducer frequency	approx. 300 kHz
Response delay	≤ 75 ms

Release date: 2023-02-16 Date of issue: 2023-02-16 Filename: 233243\_eng.pdf

Refer to "General Notes Relating to Pepperl+Fuchs Product Information".

Pepperl+Fuchs Group  
www.pepperl-fuchs.com

USA: +1 330 486 0001  
fa-info@us.pepperl-fuchs.com

Germany: +49 621 776 1111  
fa-info@de.pepperl-fuchs.com

Singapore: +65 6779 9091  
fa-info@sg.pepperl-fuchs.com

**pf** PEPPERL+FUCHS

## Technical Data

<b>Limit data</b>		
Permissible cable length		max. 300 m
<b>Indicators/operating means</b>		
LED yellow		object inside the scanning range
<b>Electrical specifications</b>		
Rated operating voltage	$U_e$	24 V DC
Operating voltage	$U_B$	20 ... 30 V DC , ripple 10 % <sub>SS</sub> ; 12 ... 20 V DC sensitivity reduced to 90 %
No-load supply current	$I_0$	≤ 20 mA
Time delay before availability	$t_v$	≤ 150 ms
<b>Input</b>		
Input type		1 program input
Level		low level : 0 ... 0.7 V (Teach-In active) high level : $U_B$ or open input (Teach-In inactive)
Input impedance		16 kΩ
Pulse length		≥ 3 s
<b>Output</b>		
Output type		Frequency output , PNP
Rated operating current	$I_e$	100 mA , short-circuit/overload protected
Voltage drop	$U_d$	≤ 2 V
Resolution		Standard: 2 Hz / mm , low: 1 Hz / mm
Repeat accuracy		± 2.5 %
Off-state current	$I_r$	≤ 0.01 mA
Output frequency		Standard: 80 ... 800 Hz , low (adjustable): 40 ... 400 Hz
Temperature influence		0.17 %/K
<b>Compliance with standards and directives</b>		
Standard conformity		
Standards		EN IEC 60947-5-2:2020 IEC 60947-5-2:2019
<b>Approvals and certificates</b>		
UL approval		cULus Listed, Class 2 Power Source
CCC approval		CCC approval / marking not required for products rated ≤36 V
<b>Ambient conditions</b>		
Ambient temperature		-25 ... 70 °C (-13 ... 158 °F)
Storage temperature		-40 ... 85 °C (-40 ... 185 °F)
Shock resistance		30 g , 11 ms period
Vibration resistance		10 ... 55 Hz , Amplitude ± 1 mm
<b>Mechanical specifications</b>		
Connection type		M8 x 1 connector , 4-pin
Degree of protection		IP67
<b>Material</b>		
Housing		Polycarbonate
Transducer		epoxy resin/hollow glass sphere mixture; polyurethane foam
Installation position		any position
Mass		10 g
Tightening torque, fastening screws		max. 0.2 Nm

Release date: 2023-02-16 Date of issue: 2023-02-16 Filename: 233243\_eng.pdf

Refer to "General Notes Relating to Pepperl+Fuchs Product Information".

Pepperl+Fuchs Group  
www.pepperl-fuchs.comUSA: +1 330 486 0001  
fa-info@us.pepperl-fuchs.comGermany: +49 621 776 1111  
fa-info@de.pepperl-fuchs.comSingapore: +65 6779 9091  
fa-info@sg.pepperl-fuchs.com

**PEPPERL+FUCHS**

## Connection

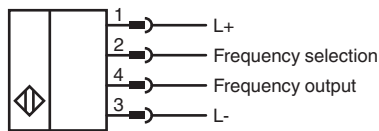

## Connection Assignment



Wire colors in accordance with EN 60947-5-2

1	BN	(brown)
2	WH	(white)
3	BU	(blue)
4	BK	(black)

## Characteristic Curve

### Characteristic response curve

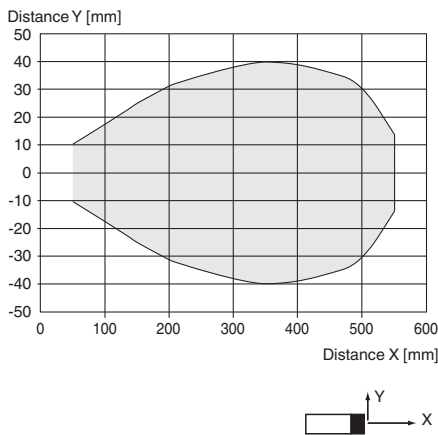

## Commissioning

### Adjustment Possibilities

The sensor is equipped with an analog frequency output. The frequency delivered at the analog output (square wave signal) changes linearly with the object distance. It is possible to select between two frequency ranges via the frequency selection input of the sensor. Switching the potential at the frequency selection input during operation does not change the output frequency range.

### Further Documentation



For information on programming the frequency selection input you may refer to the commissioning instruction.

## Accessories

	<b>UB-PROG4-V31</b>	Programming unit for ultrasonic sensors with Teach-in input at pin 2
---	---------------------	--

Release date: 2023-02-16 Date of issue: 2023-02-16 Filename: 233243\_eng.pdf

**Accessories**

	<b>OMH-ML7-01</b>	Mounting aid for ML7 and ML8 series, Mounting bracket
	<b>V31-GM-2M-PVC</b>	Female cordset single-ended M8 straight A-coded, 4-pin, PVC cable grey
	<b>V31-WM-2M-PVC</b>	Female cordset single-ended M8 angled A-coded, 4-pin, PVC cable grey

Release date: 2023-02-16 Date of issue: 2023-02-16 Filename: 233243\_eng.pdf

Refer to "General Notes Relating to Pepperl+Fuchs Product Information".

Pepperl+Fuchs Group  
www.pepperl-fuchs.com

USA: +1 330 486 0001  
fa-info@us.pepperl-fuchs.com

Germany: +49 621 776 1111  
fa-info@de.pepperl-fuchs.com

Singapore: +65 6779 9091  
fa-info@sg.pepperl-fuchs.com